

# eConcept

T É C N I C O



# eConcept

T É C N I C O

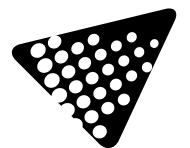

prilux



# motivos

motif  
motifs  
motives

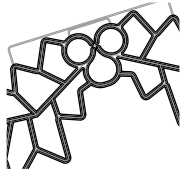

Colección Straight 24

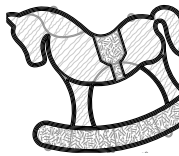

Colección Toy 38



Colección Curly 46

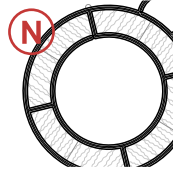

Colección Fantasy 58



Accesorios 64

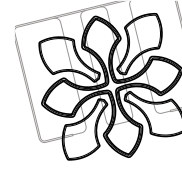

Colección Edén 66

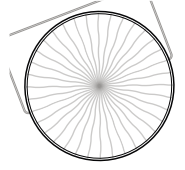

Colección Helix 70



Letreros Corporeos 78



Letreros 81

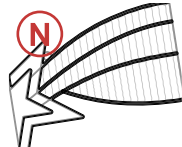

Calle 102



Farola, Calle y Fachada 111

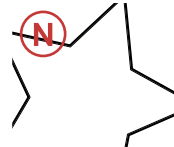

Mini 144



3D 152

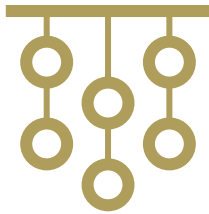

# Sistemas dinámicos

Dynamic systems  
Systèmes dynamiques  
Sistemas dinâmicos

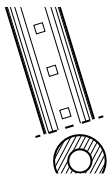

Flexilight RGB 214

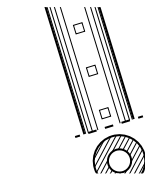

Flexilight CW-WW 215

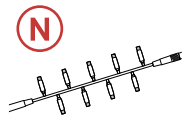

String Plus 100 RGBWW 217

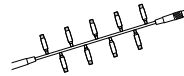

String Plus 100 RGB 218

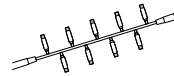

String Plus 100 CW-WW 219

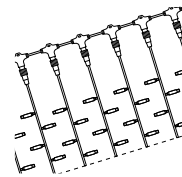

Screenlight RGB 220

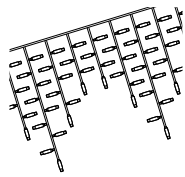

Icicle RGB 221

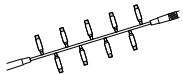

String Plus 100 24V RGB/CW-WW 224

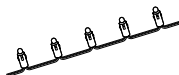

String PIXELMAX 228

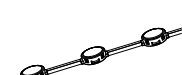

Dot DMX PIXELMAX 230

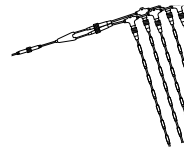

Screen PIXELMAX 232

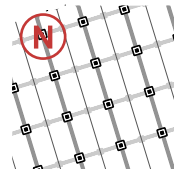

Mesh PIXELMAX 234



Accesorios 238



# Flexilight

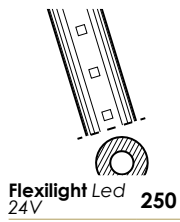

**Flexilight Led 24V** 250

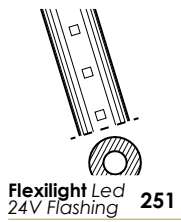

**Flexilight Led 24V Flashing** 251

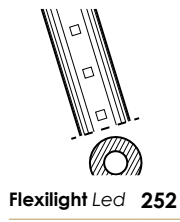

**Flexilight Led 252**

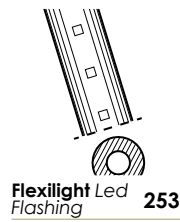

**Flexilight Led Flashing** 253

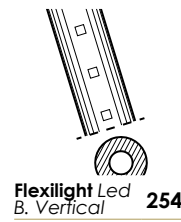

**Flexilight Led B. Vertical** 254

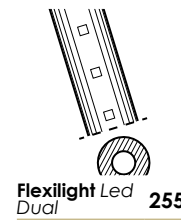

**Flexilight Led Dual** 255

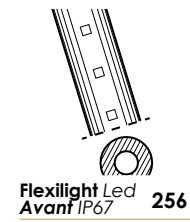

**Flexilight Led Avant IP67** 256

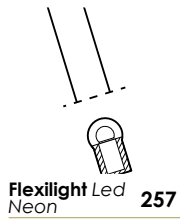

**Flexilight Led Neon** 257

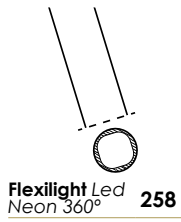

**Flexilight Led Neon 360°** 258

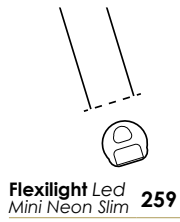

**Flexilight Led Mini Neon Slim** 259

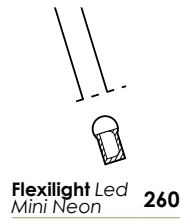

**Flexilight Led Mini Neon** 260



**Flexilight Led Double Neon** 261

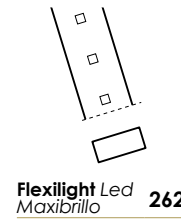

**Flexilight Led Maxibrillo** 262

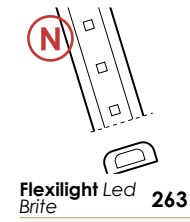

**Flexilight Led Brite** 263

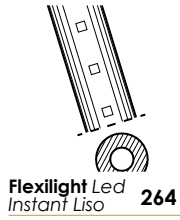

**Flexilight Led Instant Liso** 264

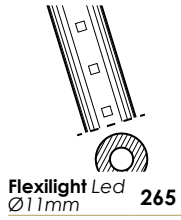

**Flexilight Led Ø11mm** 265



**Accesorios** 266

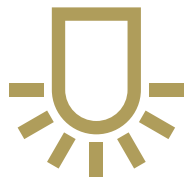

# minimalist

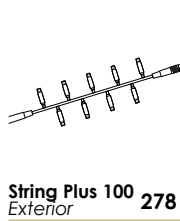

**String Plus 100 Exterior** 278

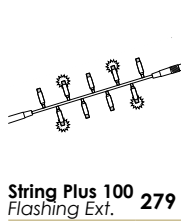

**String Plus 100 Flashing Ext.** 279

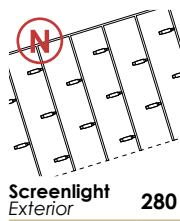

**Screenlight Exterior** 280

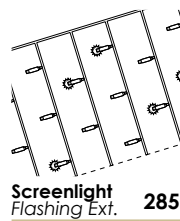

**Screenlight Flashing Ext.** 285

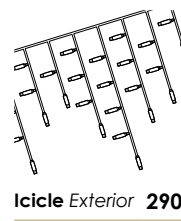

**Icicle Exterior** 290

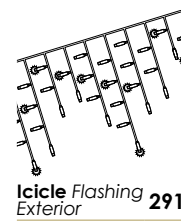

**Icicle Flashing Exterior** 291

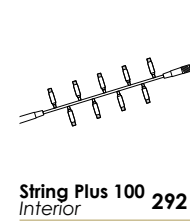

**String Plus 100 Interior** 292

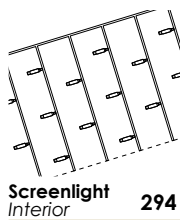

**Screenlight Interior** 294

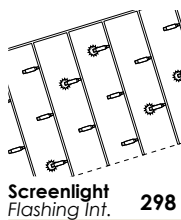

**Screenlight Flashing Int.** 298

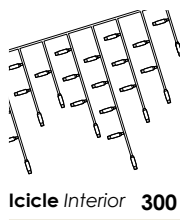

**Icicle Interior** 300

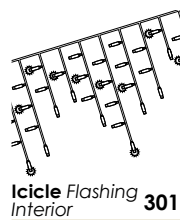

**Icicle Flashing Interior** 301

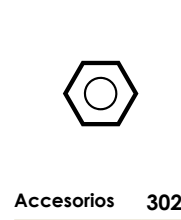

**Accesorios** 302



# Led Exterior

Outdoors Led  
Led à l'exterieur  
Led ao ar livre

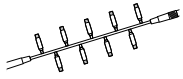

**String Avant IP67 306**

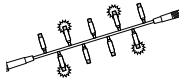

**String Avant Flashing IP67 307**

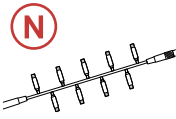

**String Plus 180 24V Tuente al. 308**

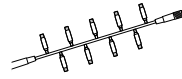

**String Plus 180 24V transf. 310**

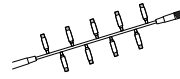

**String Plus 180 1seccion 311**

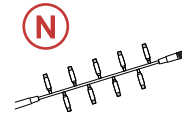

**String Plus 180 312**

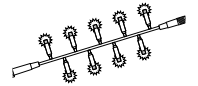

**String Plus 120 ALL Flashing 314**

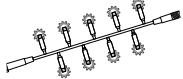

**String Plus 180 Sparkle 315**

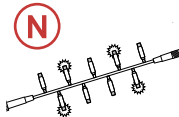

**String Plus 180 Flashing 316**

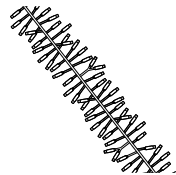

**Cluster Light Fall Lite 318**

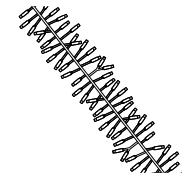

**Cluster Light Flashing 320**

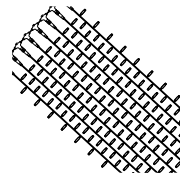

**Techo Luz Screenlight Flash 321**

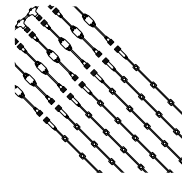

**Techo Luz 322**

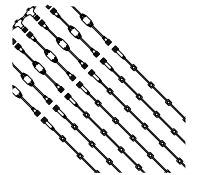

**Techo Luz Flashing 323**

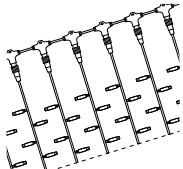

**Screenlight 24V 324**

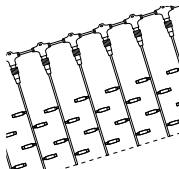

**Screenlight 326**

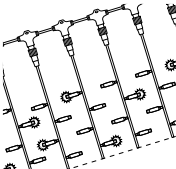

**Screenlight Flashing 330**

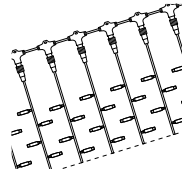

**Screenlight Dual 334**

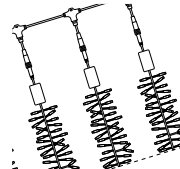

**Screenlight 250 Fall Lite 336**

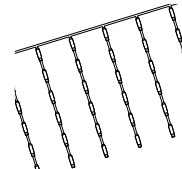

**Screen Rain 337**

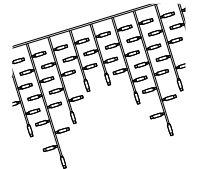

**Icicle 338**

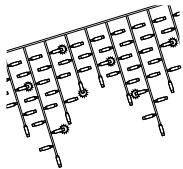

**Icicle Flashing 340**

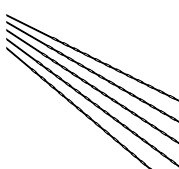

**Cascada 342**

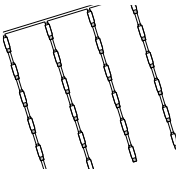

**Screenlight Cascada 344**

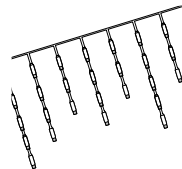

**Icicle Cascada 345**

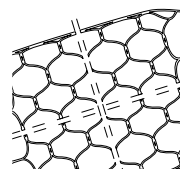

**Red 24V Transf. 346**

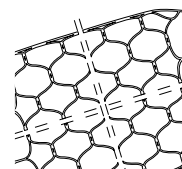

**Red 24V Fuente 347**

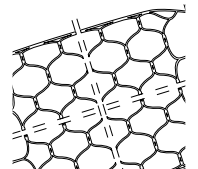

**Red 348**

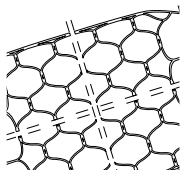

**Red Flashing 350**



**Accesorios 352**



# Led Interior

Indoors Led  
Led à l'interieur  
Led interior

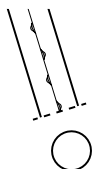

**Flexilight Ø7mm 363**

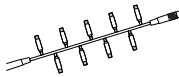

**String Plus 180 364**

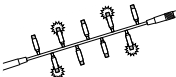

**String Plus 180 Flashing 365**

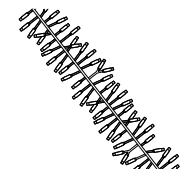

**Cluster Light Fall Lite 366**

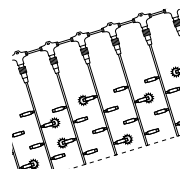

**Screenlight Flashing 368**

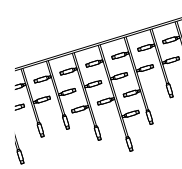

**Icicle 370**



**Accesorios 372**



# deco

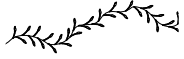

Cluster MICROLED 376

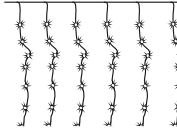

Icicle MICROLED 377

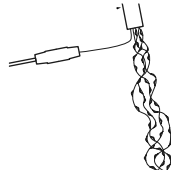

Branch Tree 378



Branch String 379

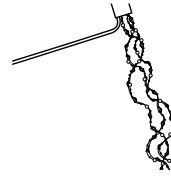

Branch Crystal 379

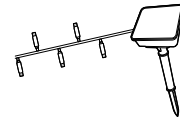

Solar String 380

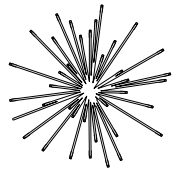

LED Fireworks 381

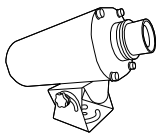

Nesso 382



Nesso STEDY 383

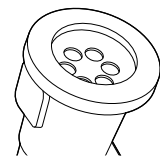

Giro Snowflake 384

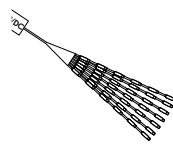

Willow Light 386

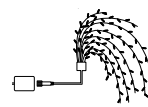

LED Fountain 388

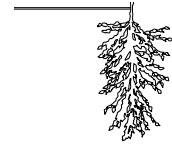

Deco Branch 389

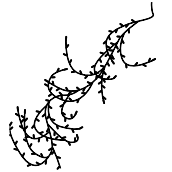

Branch LED 390



Spiral 391



Snow Tree 392



Golden Tree 393



Willow Tree 394



Winter Tree 394



Birch Tree 395



Christmas Tree 396



Ball 3D MICROLED 398



Star Gold Line 3D 399



Star Flat 400



Star Copper 400



Star Glass Balls 401



Cluster Glass Balls 401

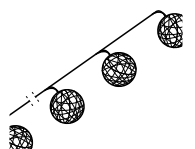

Cotton Balls 402

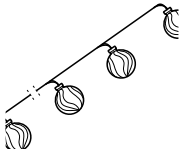

Glass Balls Chain 403

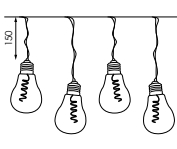

esSense Plastic Balls 403

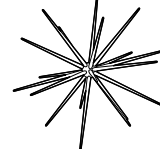

Spike Star 404

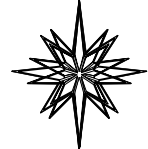

Glitter Star 404



Glitter Loop 405

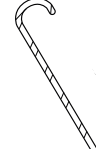

Candy Cane 405

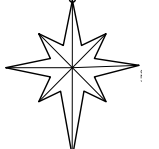

Ocean Comet 406

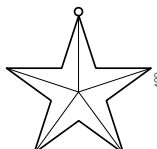

Ocean Star 406



Ocean Cone 407



Elegant Cone 408

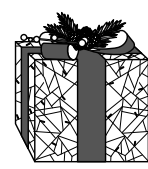

Elegant Gift 409

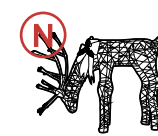

Elegant Deer 409



Glacier Deer Set 411

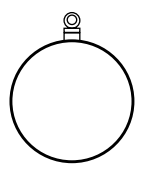

Christmas Balls 412



Cluster Balls 416

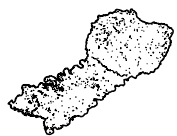

Branch 417

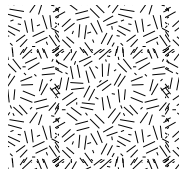

Tapiz 418

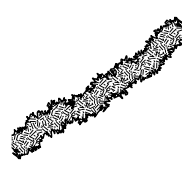

Garland 419

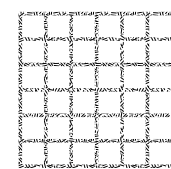

Tapiz NET 420

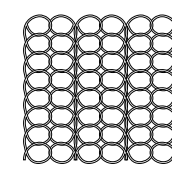

PVC NET 421

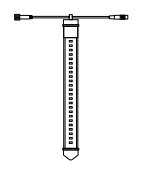

Fall Lite LED SMART 422



## deco

---



Fall Lite LED 424

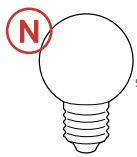

Lámparas LED 425

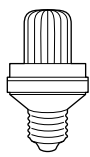

Flash Light LED 428

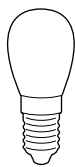

Lámparas INCANDESCENCIA 429

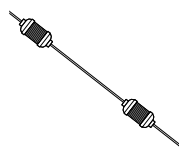

String Flash 430

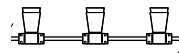

Guirnalda E14/E27 432



Accesorios 434



## Anexos

---

Annexes  
Annexes  
Anexos

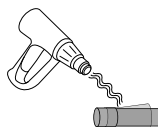

Guía  
Mantenimiento 430



Condiciones  
Generales 442



Certificaciones 444

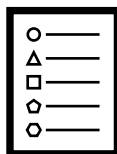

Simbología 445



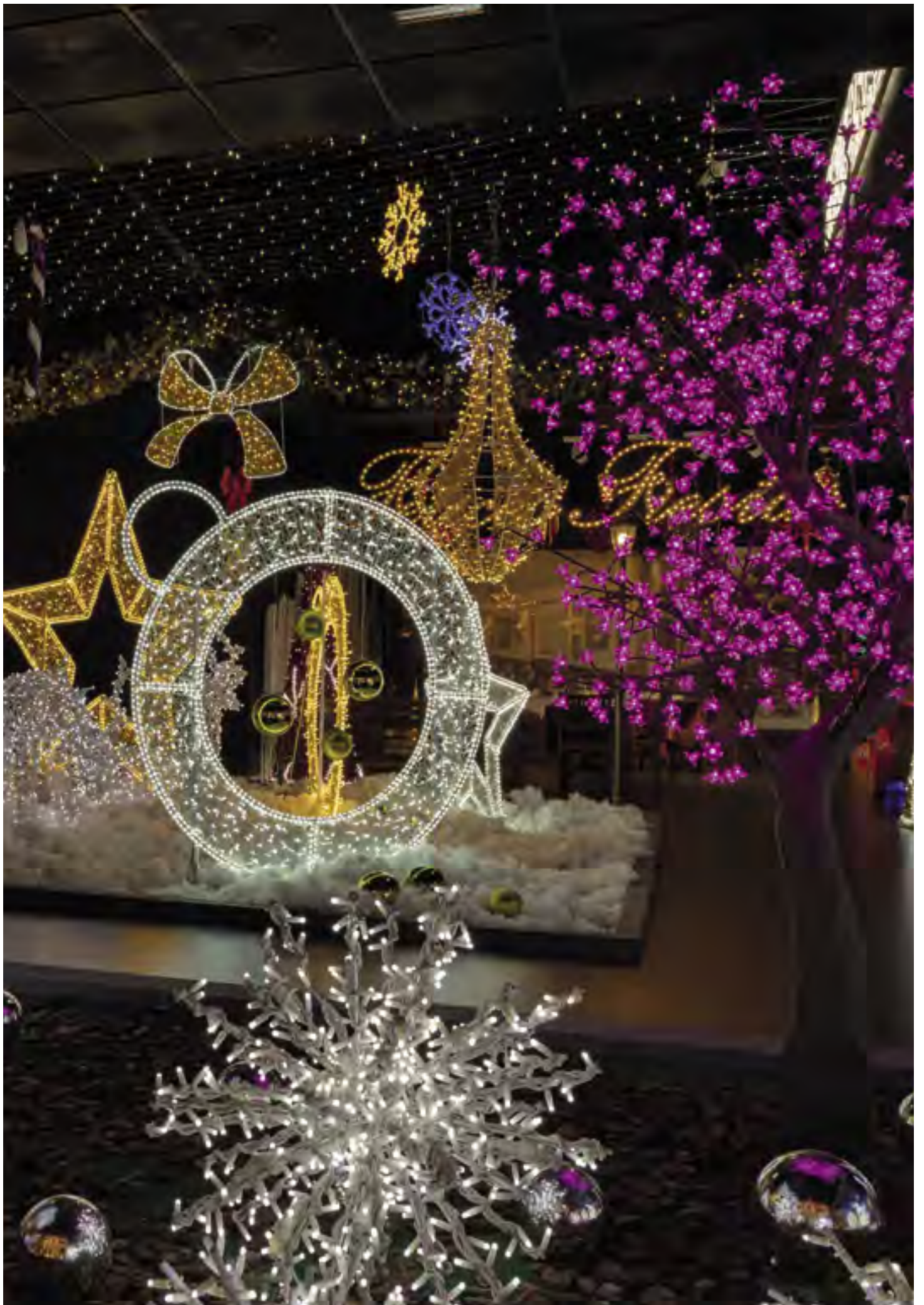

**Prilux es una empresa española con más de 35 años de experiencia en el sector de la iluminación.**

**En Prilux nos esforzamos día tras día por ser una de las empresas de iluminación de referencia a nivel mundial al ofrecer al mercado, alta tecnología en iluminación con una relación calidad/precio insuperable y un asesoramiento personalizado a nuestros clientes en sus proyectos ofreciendo un servicio más eficaz.**

**Somos un equipo joven, dinámico y multidisciplinar compuesto por más de 200 profesionales entre los cuales más de 20 ingenieros forman parte del departamento de I+D, proyectos y de nuestro laboratorio propio.**

Prilux is a Spanish company with more than 35 years of experience in the lighting sector.

At Prilux we strive day after day to be one of the world's leading lighting companies by offering the market high technology in lighting with an unbeatable quality / price ratio and personalized advice to our clients on their projects by offering a more service. effective.

We are a young, dynamic and multidisciplinary team made up of more than 200 professionals, among which more than 20 engineers are part of the R&D department, projects and our own laboratory.

Prilux est une entreprise espagnole avec plus de 35 ans d'expérience dans le secteur de l'éclairage.

Chez Prilux nous nous efforçons jour après jour d'être l'un des leaders mondiaux de l'éclairage en offrant au marché la haute technologie de l'éclairage avec un rapport qualité / prix imbattable et des conseils personnalisés à nos clients sur leurs projets en offrant un service plus efficace.

Nous sommes une équipe jeune, dynamique et multidisciplinaire composée de plus de 200 professionnels, parmi lesquels plus de 20 ingénieurs font partie du département R&D, des projets et de notre propre laboratoire.

A Prilux é uma empresa espanhola com mais de 35 anos de experiência no setor da iluminação.

Na Prilux esforçamo-nos dia após dia para ser uma das empresas líderes mundiais em iluminação, oferecendo ao mercado alta tecnologia em iluminação com uma relação qualidade / preço imbatível e um aconselhamento personalizado aos nossos clientes nos seus projectos, oferecendo um serviço mais eficaz.

Somos uma equipa jovem, dinâmica e multidisciplinar composta por mais de 200 profissionais, entre os quais mais de 20 engenheiros fazem parte do departamento de I&D, projectos e laboratório próprio.



# Infraestructuras

Infrastructures  
Infrastructures  
Infraestructuras

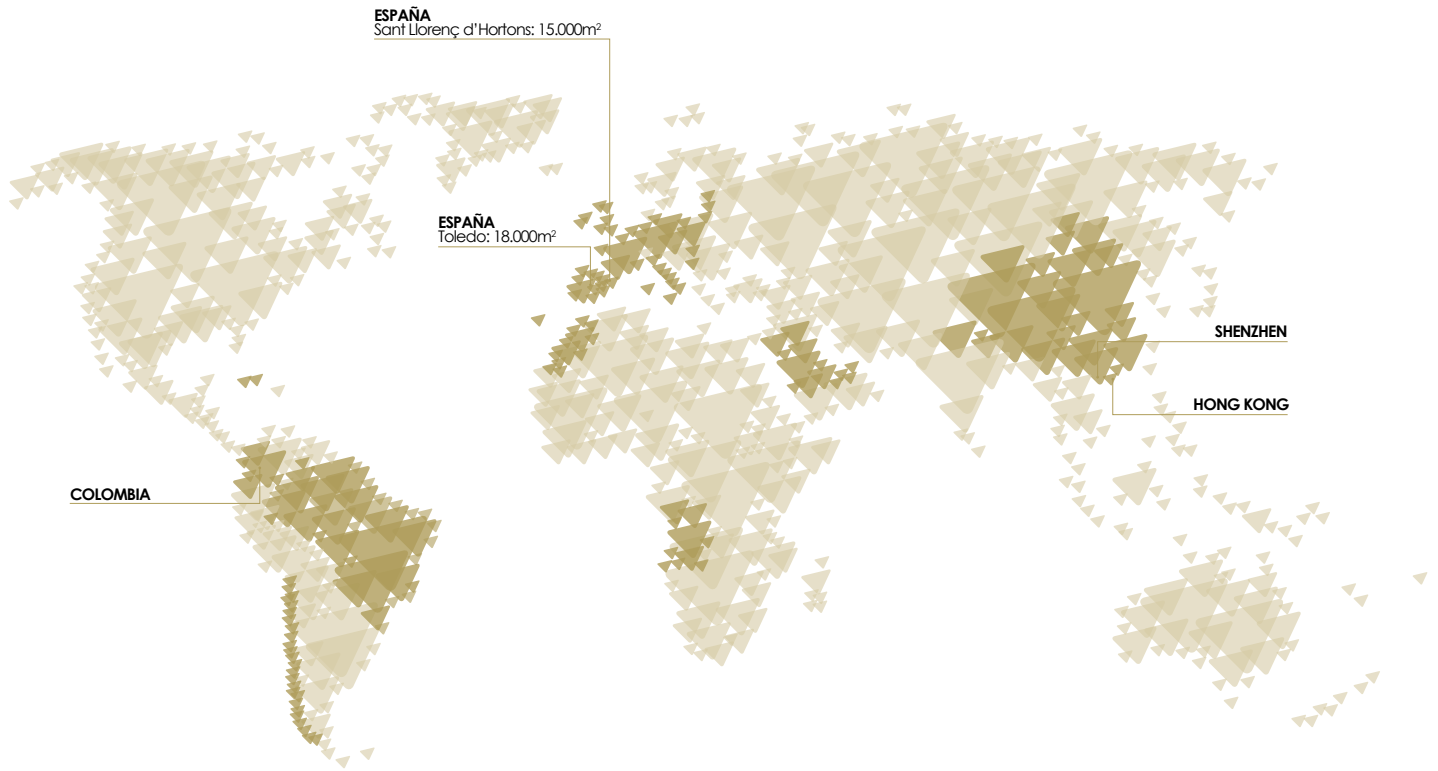

**La Sede Central de Prilux está situada en Toledo. Cuenta con 18.000m<sup>2</sup> repartidos en línea de producción, almacén, oficinas, showrooms, laboratorio, salas blancas...**

**En Prilux apostamos por la innovación, la fabricación propia y la internacionalización.**

**Prilux cuenta con una delegación en Barcelona, situada en Sant Llorenç d'Hortons para nuestra división Prilux eConcept que alberga 15.000m<sup>2</sup>. Sirve como plataforma logística para nuestra expansión por Europa y Europa del Este.**

**Fuera de España disponemos de delegaciones comerciales en Niza, Oporto, Moscú, Colombia y Shenzhen.**

**Tras 30 años centrados en el mercado español, exportamos principalmente a Europa, Europa del Este, Norte de África, Oriente Medio, América del Sur y Australia.**

Prilux Headquarters are located in Toledo. It has 18,000m<sup>2</sup> distributed in production line, warehouse, offices, showrooms, laboratory, clean rooms...

At Prilux we are committed to innovation, our own manufacturing and internationalization.

Prilux has a delegation in Barcelona, located in Sant Llorenç d'Hortons for our Prilux eConcept division, which houses 15,000m<sup>2</sup>. It serves as a logistics platform for our expansion into Europe and Eastern Europe.

Outside of Spain we have commercial delegations in Nice, Porto, Moscow, Colombia and Shenzhen.

After 30 years focused on the Spanish market, we export mainly to Europe, Eastern Europe, North Africa, the Middle East, South America and Australia.

Le siège social de Prilux est situé à Tolède. Il dispose de 18000 m<sup>2</sup> répartis en ligne de production, entrepôt, bureaux, showrooms, laboratoire, salles blanches...

Chez Prilux, nous sommes engagés dans l'innovation, notre propre fabrication et l'internationalisation.

Prilux a une délégation à Barcelone, située à Sant Llorenç d'Hortons pour notre division Prilux eConcept, qui compte 15 000 m<sup>2</sup>. Il sert de plateforme logistique pour notre expansion en Europe et en Europe de l'Est.

En dehors de l'Espagne, nous avons des délégations commerciales à Nice, Porto, Moscou, Colombie et Shenzhen.

Après 30 ans centrés sur le marché espagnol, nous exportons principalement vers l'Europe, l'Europe de l'Est, l'Afrique du Nord, le Moyen-Orient, l'Amérique du Sud et l'Australie.

A sede da Prilux está localizada em Toledo. Possui 18.000m<sup>2</sup> distribuídos em linha de produção, almoxarifado, escritórios, showrooms, laboratório, salas limpas...

Na Prilux apostamos na inovação, na fabricação própria e na internacionalização.

A Prilux tem uma delegação em Barcelona, localizada em Sant Llorenç d'Hortons, para a nossa divisão Prilux eConcept, que aloja 15.000m<sup>2</sup>. Ele serve como uma plataforma logística para nossa expansão na Europa e no Leste Europeu.

Fora da Espanha, temos delegações comerciais em Nice, Porto, Moscou, Colômbia e Shenzhen.

Após 30 anos focados no mercado espanhol, exportamos principalmente para Europa, Europa Oriental, Norte da África, Oriente Médio, América do Sul e Austrália.

Drilux



**En Prilux focalizamos todos nuestros esfuerzos de I+D, en la tecnología LED. Somos especialistas en el desarrollo, fabricación y aplicación de soluciones innovadoras de iluminación LED y sistemas de control y gestión inteligentes. Diseñamos, fabricamos y comercializamos lámparas, luminarias de interior y exterior y soluciones de iluminación a la altura de las necesidades y exigencias de nuestros clientes. Disfrutamos construyendo una empresa de alta tecnología en iluminación LED.**

**Para el desarrollo de nuestras luminarias "Made in Spain" y de luminarias especiales bajo requerimientos de nuestros clientes, nuestro equipo de ingenieros y "lighting designers", utilizan la última tecnología en software de ingeniería. Este tipo de software permite mejorar la calidad de nuestros productos, aumentar la robustez y durabilidad, optimizar las soluciones de ingeniería de nuestras luminarias, reducir el tiempo de desarrollo y adaptarnos a los cambios del sector de forma más ágil.**

In Prilux we focus all our efforts on R&D, specifically on the LED technology. We specialise in the development, manufacture and application of innovative solutions for LED lighting and smart control and management systems. We design, manufacture and market fixtures, indoor and outdoor luminaires and lighting solutions which match the needs and requirements of our clients. We enjoy building up a company of high-technology LED lighting.

For the development of our "Made in Spain" luminaires and the special luminaires required by our clients, our engineering team and "lighting designers" use the latest engineering software technology. This type of software allows improving the quality of our products, increasing their robustness and durability, optimising the engineering solutions of our luminaires, reducing the time of development and, in essence, gives us the opportunity to adapt more effectively to changes in the sector.

Chez Prilux, nous focalisons tous nos efforts de R&D sur la technologie LED. Nous sommes spécialistes dans le développement, la fabrication et l'application de solutions innovantes d'éclairage LED et de systèmes de contrôle et gestion intelligents. Nous concevons, fabriquons et commercialisons des lampes, des luminaires d'intérieur et d'extérieur, ainsi que des solutions d'éclairage conformément aux besoins et aux exigences de nos clients. Nous en profitons pour construire une entreprise de haute technologie d'éclairage LED.

Pour le développement de nos luminaires « Made in Spain » et des luminaires spéciaux répondant aux exigences de nos clients, notre équipe d'ingénieurs et de « lighting designers » utilise la dernière technologie en logiciel d'ingénierie. Ce type de logiciel permet d'améliorer la qualité de nos produits, d'augmenter la robustesse et la durabilité, d'optimiser les solutions d'ingénierie de nos luminaires, de réduire le temps de développement et de nous adapter aux changements du secteur d'une forme plus rapide.

Na Prilux focalizámos todos os nossos esforços de I+D, na tecnologia LED. Somos especialistas em desenvolvimento, fabrico e aplicação de soluções inovadoras de iluminação LED, sistemas de controlo e gestão inteligentes. Desenhamos, fabricamos e comercializámos lâmpadas, luminárias de interior e exterior e soluções de iluminação à altura das necessidades e exigências dos nossos clientes. Disfrutámos construindo uma empresa de alta tecnologia na iluminação LED.

Para o desenvolvimento das nossas luminárias "Made in Spain" e de luminárias especiais a pedido pelos nossos clientes, a nossa equipa de engenharia e "lighting designers", utilizam a última tecnologia em software de engenharia. Este tipo de software permite melhorar a qualidade dos nossos produtos, aumentar a robustez e durabilidade, optimizar as soluções de engenharia das nossas luminárias, reduzir o tempo de desenvolvimento e adaptarmo-nos às mudanças do sector de forma mais ágil.



# Producción y Calidad

*Production and quality*

*Production et qualité*

*Produção e Qualidade*

**Todos nuestros módulos LED se fabrican dentro de nuestras propias instalaciones, contando con una "Sala Blanca" equipada con una línea automática de montaje de componentes SMD (Serigrafía - Pick & Place - Horno). Diseñamos nuestras propias PCB a partir de las cuales fabricamos los módulos destinados a las soluciones lumínicas "Made in Spain".**

**Nuestros procesos de producción están completamente informatizados lo que nos permite llevar un exhaustivo control de calidad y una total trazabilidad del producto en cualquiera de sus etapas de fabricación cumpliendo siempre, la normativa vigente.**

All our LED modules are manufactured within our own facilities, which include a "White Room" equipped with an automatic assembly line of SMD components (Screen printing - Pick & Place - Furnace). We design our own PCBs, WITH which we manufacture the modules aimed at the "Made in Spain" lighting solutions.

Our production processes are totally computerised, enabling a thorough quality control and the comprehensive traceability of the product in any stage of production, always in compliance with the required standards.

Tous nos modules LED sont fabriqués dans nos propres installations et nous disposons d'une « salle blanche » équipée d'une ligne automatique de montage de composants SMD (sérigraphie - pick & place - four). Nous concevons nos propres PCB à partir desquels nous fabriquons les modules destinés aux solutions d'éclairage « Made in Spain ».

Nos processus de production sont entièrement automatisés, ce qui nous permet de réaliser un contrôle de qualité exhaustif et une traçabilité totale du produit à n'importe quelle étape de fabrication, en respectant toujours la réglementation en vigueur.

Todos os nossos módulos LED são fabricados dentro das nossas próprias instalações, para isso dispomos de uma "Sala Branca" equipada com uma linha automática de montagem de componentes SMD (Serigrafia - Pick & Place - Forno). Desenhamos as nossas próprias PCB a partir das quais fabricamos os módulos destinados às soluções lumínicas "Made in Spain".

Os nossos processos de produção estão completamente informatizados o que nos permite chegar a um exaustivo controlo de qualidade e a uma total leitura do percurso do produto em qualquer das suas etapas de fabrico cumprindo sempre, a normativa em vigor.



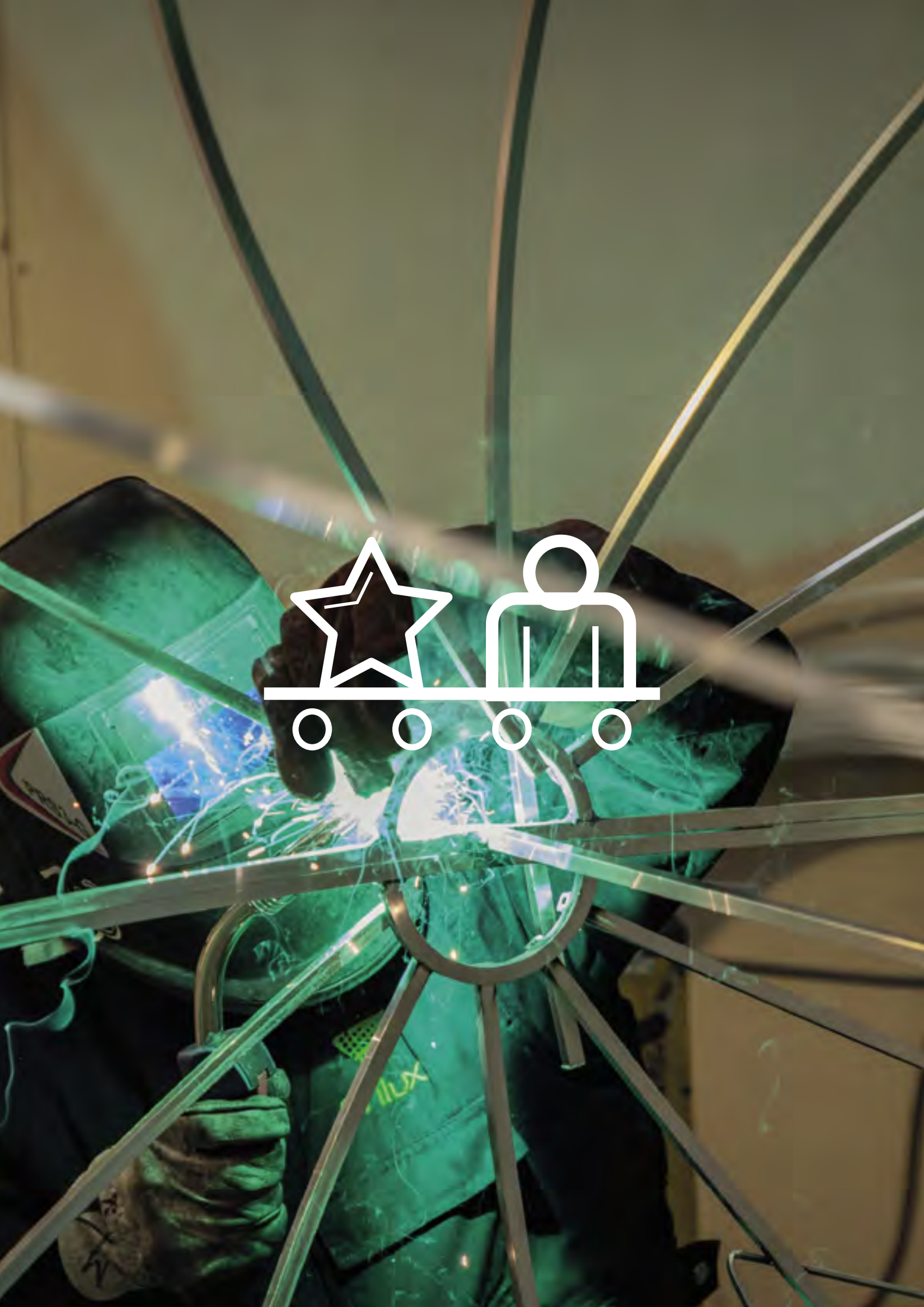

# Laboratorio

---

Laboratory

Laboratoire

Laboratório

**Prilux dispone de un completo laboratorio provisto de un amplio equipamiento de última generación para el testeo y ensayo, según normas y directrices, de luminarias y fuentes de luz.**

**Así aseguramos el cumplimiento de los requisitos normativos vigentes con los más altos estándares de calidad para todos nuestros desarrollos y productos.**

Prilux has a complete laboratory equipped with extensive state-of-the-art equipment for testing and testing, according to standards and guidelines, of luminaires and light sources.

These tests guarantee the fulfilment of the existing regulatory requirements and the highest quality standards for all our developments and products.

Prilux dispose d'un laboratoire complet équipé d'un équipement ultramoderne complet pour tester et tester, conformément aux normes et directives, des luminaires et des sources lumineuses.

Nous garantissons ainsi le respect des exigences réglementaires en vigueur avec les standards de qualité les plus stricts pour tous nos développements et produits.

A Prilux possui um laboratório completo equipado com extensos equipamentos de última geração para testes e testes, de acordo com as normas e diretrizes, de luminárias e fontes de luz.

Assim assegurámos o cumprimento dos requisitos normativos em vigor com os mais altos standards de qualidade para todos os nossos desenvolvimentos de produtos.



# Proyectos

Projects

Projets

Projetos

**Para las obras con mayores exigencias técnicas ponemos a disposición de nuestros clientes el departamento de proyectos, en el cual se estudian y diseñan soluciones lumínicas a través de software específico para ello.**

**Actualmente disponemos de soluciones tecnológicas de iluminación con sistemas de control integrados según demanda para la industria, oficinas, alumbrado público y vial, tiendas de retail, supermercados y centros comerciales, aplicaciones deportivas, parkings, hoteles, hospitales, colegios y universidades... Aportamos soluciones de iluminación creativas, personalizadas y adaptadas a las necesidades de nuestros clientes y ajustadas a la norma con un enfoque particular hacia el bienestar humano y la eficiencia energética.**

For projects of major technical demand we provide our clients with access to the projects' department, which studies and designs lighting solutions by means of software specifically tailored for this purpose.

At present we provide on-demand lighting technological solutions with integrated control systems for industrial facilities, offices, public and street lighting, retail stores, supermarkets and shopping centres, sport facilities, car parks, hotels, hospitals, schools and universities... We offer creative, customised lighting solutions adapted to the needs of our clients and in compliance with regulations, with a particular focus on human welfare and energy efficiency.

Pour les travaux présentant les exigences techniques les plus importantes, nous mettons à disposition de nos clients le département des projets, où les solutions d'éclairage sont étudiées et conçues grâce à un logiciel spécifique.

Nous disposons actuellement de solutions technologiques d'éclairage avec des systèmes de contrôle intégrés en fonction de la demande pour l'industrie, les bureaux, l'éclairage public et routier, les boutiques de vente au détail, les supermarchés et les centres commerciaux, les applications sportives, les parkings, les hôtels, les hôpitaux, les écoles et les universités... Nous fournissons des solutions d'éclairage créatives, personnalisées et adaptées aux besoins de nos clients, mais aussi conformes à la réglementation, avec une approche particulière focalisée sur le bien-être humain et l'efficacité énergétique.

Para as obras com maiores exigências técnicas colocámos á disposição dos nossos clientes o nosso departamento de projectos, no qual se estudam e desenham soluções lumínicas através de software específico para o efeito.

Actualmente dispomos de soluções tecnológicas de iluminação com sistemas de controlo integrados a pedido para a indústria, escritórios, iluminação pública e viária, lojas de retalho, supermercados e centros comerciais, aplicações desportivas, parques de estacionamento, hotéis, hospitais, escolas e universidades... Temos soluções de iluminação criativas, personalizadas e adaptadas às necessidades dos nossos clientes e ajustadas à norma com um foco particular no bem estar do ser humano e na eficiência energética.

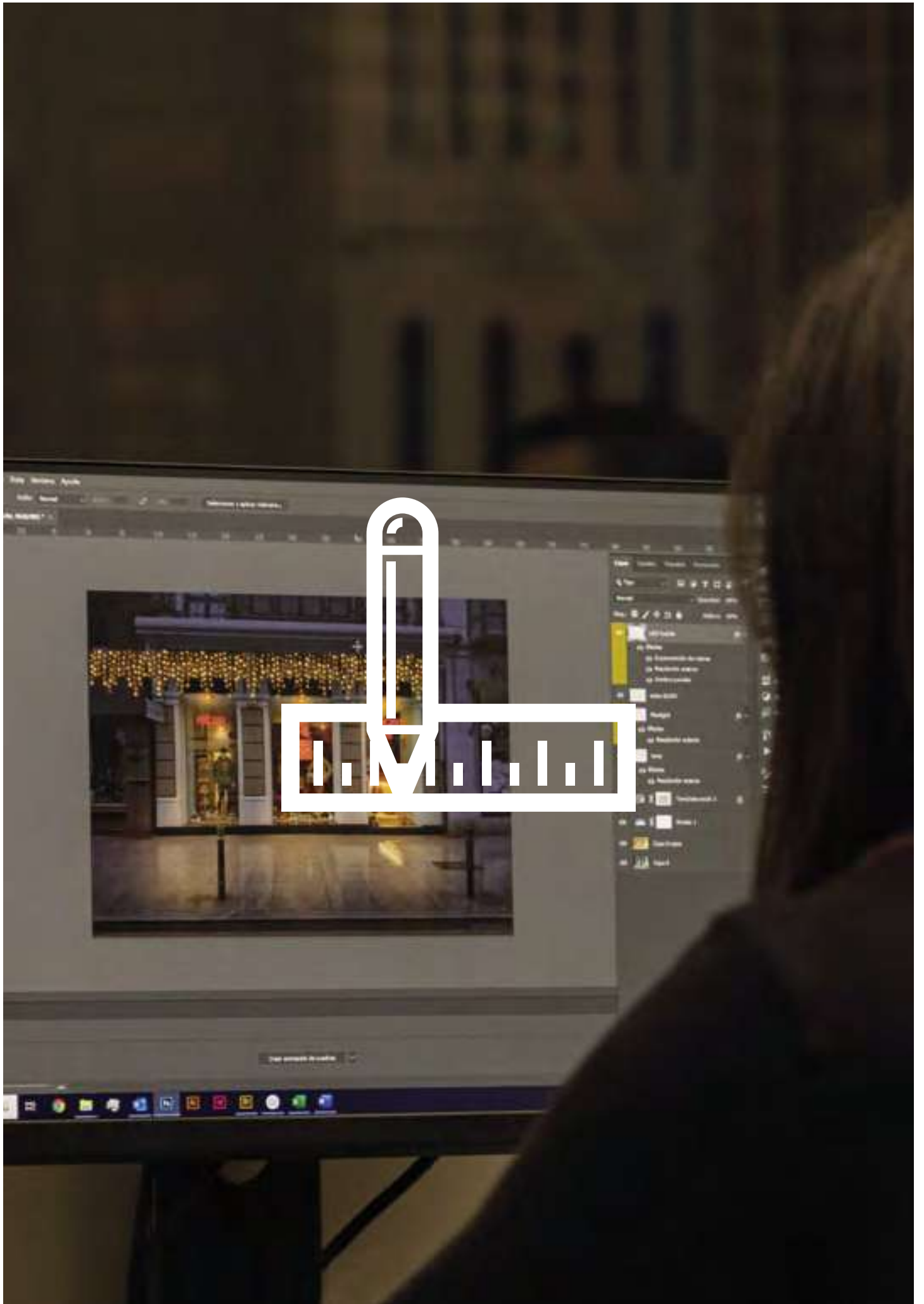

# Hacemos realidad tus ideas

Production and quality

Production et qualité

Produção e Qualidade



## IDEACIÓN DE LA CAMPAÑA

CAMPAIGN BRAINSTORMING  
IDEATION DE LA CAMPAGNE  
IDEAÇÃO DA CAMPANHA

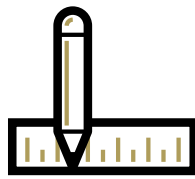

## PROYECTOS

PROJECTS  
PROJETS  
PROJETOS

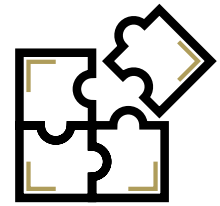

## MONTAJE

MOUNTING  
ASSEMBLAGE  
MONTAGEM



## FASE COMERCIAL

COMMERCIAL STEP  
PHASE COMMERCIALE  
FASE COMERCIAL

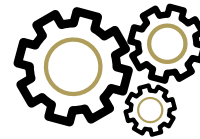

## FABRICACIÓN

MANUFACTURING  
FABRICATION  
FABRICAÇÃO

En PRILUX diseñamos y producimos el 100% de los motivos en nuestras instalaciones de Toledo garantizando, su alta calidad y el cumplimiento de los plazos de entrega. Esto nos permite ofrecer la posibilidad, bajo pedido, de personalización de motivos adaptados totalmente a las necesidades y exigencias del cliente.

Nuestro departamento de Proyectos realiza simulaciones de decoraciones a partir de fotografías en las que se personalizan las decoraciones según las tendencias o directrices que nos marque el cliente. Proporcionamos asesoramiento, apoyo y orientación técnica adecuada para la obtención del mejor proyecto decorativo.

In PRILUX we design and manufacture 100% of the lighting motifs in our facilities in Toledo, ensuring not only high quality but also meeting the most challenging deadlines. We offer the possibility, on demand, of customizing and adapt the motif to any kind of demands and needs from the customer.

For this purpose, our Project Department carries out simulations of decorations from photographs in which, according to the last trends and client's guidelines, we customize all the motif. Moreover, we provide to our customers a good piece of advice, support and guidance to get the best decorative project.

À PRILUX nous concevons et fabriquons le 100% des motifs lumineux dans nos installations à Tolède, assurant non seulement de haute qualité, mais aussi le respect des délais les plus serrés. Nous offrons la possibilité, sur demande, de personnaliser et adapter les motifs à tout type de demandes et besoins de nos clients.

A cet effet, notre Département du Projet réalise des simulations de décorations à partir de photographies dans lesquelles, selon les dernières tendances et les directives du client, nous personnalisons toutes les motifs. De plus, nous offrons à nos clients des conseils et du soutien pour obtenir le meilleur projet décoratif.

Em PRILUX projetamos e fabricamos o 100% dos motivos de iluminação nas nossas instalações de Toledo, garantindo não só uma alta qualidade, mas também o cumprimento dos prazos mais exigentes. Oferecemos a possibilidade, sob demanda, de personalizar e adaptar o motivo para qualquer tipo de exigências e necessidades do cliente.

Para este efeito, o nosso Departamento de Projetos realiza simulações de decorações de fotografias em que, de acordo com as últimas tendências e diretrizes do cliente, nós personalizar todo o motivo. Além disso, nós fornecemos aos nossos clientes aconselhamento, apoio e orientação para obter o melhor projeto decorativo.



*motivos*

---





# *Colección Straight*

---

*Holly  
Pine Forest  
Tree  
Reindeer Face  
Reindeer Body  
3D Tree  
3D Cone  
3D Pine Forest*



# Holly

COLECCIÓN STRAIGHT



Motivo  
Motifs  
Motifs  
Motivos



A



B



C



D

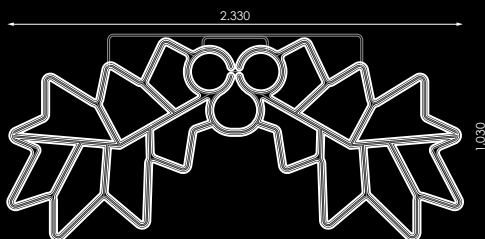

477192	A flexi LED
477260	B flexi LED

<b>W</b>							
86W	230V	CII	IP65 IP44 Plug	4kg	240x110x6cm	INC.	10mm

		<b>1</b>	<b>2</b>
477338	C flexi LED	STRING PLUS LED	PVC NET
477406	D flexi LED	STRING PLUS LED	PVC NET

<b>W</b>							
108W	230V	CII	IP65 IP44 Plug	12kg	240x110x6cm	INC.	10mm

[GRÁFICOS: Unidades en mm/ GRÁFICOS: Units in mm/ GRÁFICOS: Unidades en mm/ GRÁFICOS: Unidades en mm]

# Pine Forest

## COLECCIÓN STRAIGHT



Motivo  
Motifs  
Motifs  
Motivos

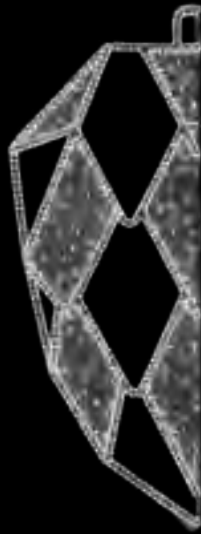

A



B

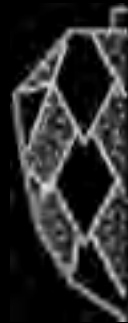

C



D



477178	A flexi LED
477246	B flexi LED

52W	230V	CII	IP65 IP44 Plug	3,5kg	215x80x6cm	INC.	10mm

		<b>1</b>	<b>2</b>
477314	C flexi LED	STRING PLUS LED	PVC NET
477383	D flexi LED	STRING PLUS LED	PVC NET

63W	230V	CII	IP65 IP44 Plug	8kg	215x80x6cm	INC.	10mm

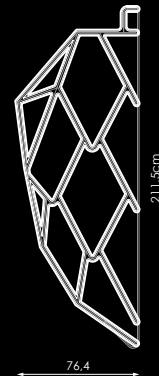



# Pine Forest

## COLECCIÓN STRAIGHT



Motivo  
Motifs  
Motifs  
Motivos



A



B



C



D

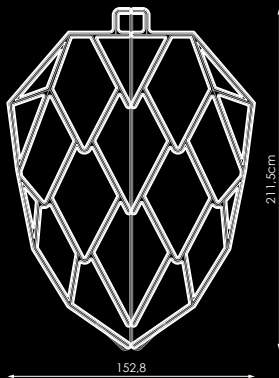

477154	A flexi LED
477222	B flexi LED

<b>W</b>							
86W	230V	CII	IP65 IP44 Plug	6kg	215x160x6cm	INC.	10mm

		<b>1</b>	<b>2</b>
477291	C flexi LED	STRING PLUS LED	PVC NET
477369	D flexi LED	STRING PLUS LED	PVC NET

<b>W</b>							
108W	230V	CII	IP65 IP44 Plug	12kg	215x160x6cm	INC.	10mm

[GRÁFICOS: Unidades en mm/ GRÁFICOS: Units in mm/ GRÁFICOS: Unidades en mm/ GRÁFICOS: Unidades en mm]

# Tree

## COLECCIÓN STRAIGHT



Motivo  
Motifs  
Motifs  
Motivos



A



B



C



D



477185	A flexi LED
477253	B flexi LED

38W	230V	CII	IP65 IP44 Plug	3,5kg	220x70x6cm	INC.	10mm

		<b>1</b>	<b>2</b>
477321	C flexi LED	STRING PLUS LED	PVC NET
477390	D flexi LED	STRING PLUS LED	PVC NET

48W	230V	CII	IP65 IP44 Plug	5kg	220x70x6cm	INC.	10mm





# Tree

## COLECCIÓN STRAIGHT



Motivo  
Motifs  
Motifs  
Motivos



A



B



C



D

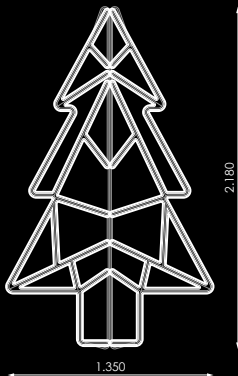

477161	A flexi LED
477239	B flexi LED

<b>W</b>							
75W	230V	CII	IP65 IP44 Plug	5kg	220x140x6cm	INC.	10mm

		<b>1</b>	<b>2</b>
477307	C flexi LED	STRING PLUS LED	PVC NET
477376	D flexi LED	STRING PLUS LED	PVC NET

<b>W</b>							
95W	230V	CII	IP65 IP44 Plug	10kg	220x140x6cm	INC.	10mm

[GRÁFICOS: Unidades en mm/ GRAFPHICS: Units in mm/ GRAFHQUÉS: Unités en mm/ GRÁFICOS: Unidades em mm]

# Reindeer Body

COLECCIÓN STRAIGHT



Motivo  
Motifs  
Motifs  
Motivos



A



B



C



D



477888	A flexi
477895	B flexi

74W	230V	CII	IP65 IP44 Plug	7,5kg	225x135x6cm	INC.	10mm

		<b>1</b>	<b>2</b>
477901	C flexi	STRING	
477918	D flexi	STRING	
		PVC NET	

84W	230V	CII	IP65 IP44 Plug	10kg	225x135x6cm	INC.	10mm

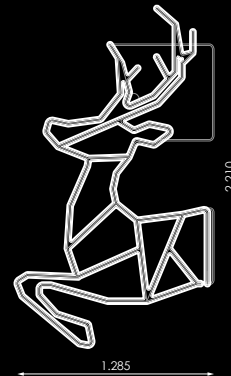





# Reindeer Body

## COLECCIÓN STRAIGHT



Motivo  
Motifs  
Motifs  
Motivos



A



B



C



D



477208	A flexi LED
477277	B flexi LED

<b>W</b>							
99W	230V	CII	IP65 IP44 Plug	7,5kg	265x215x6cm	INC.	10mm

		<b>1</b>	<b>2</b>
477345	C flexi LED	STRING PLUS LED	PVC NET
477413	D flexi LED	STRING PLUS LED	PVC NET

<b>W</b>							
113W	230V	CII	IP65 IP44 Plug	11kg	265x215x6cm	INC.	10mm

[GRÁFICOS: Unidades en mm/ GRAFPHICS: Units in mm/ GRAFHQUÉS: Unités en mm/ GRÁFICOS: Unidades em mm]

# Reindeer Face

COLECCIÓN STRAIGHT



Motivo  
Motifs  
Motifs  
Motivos



477147	A	flexi	LED
477215	B	flexi	LED

282W	230V	CII	IP65 IP44 Plug	32kg	2- 205x165x7,5cm 2- 305x133x7,5cm	INC.	25mm

		<b>1</b>	<b>2</b>
477284	C	flexi	LED
		STRING	PLUS LED
		PVC NET	
477352	D	flexi	LED
		STRING	PLUS LED
		PVC NET	

338W	230V	CII	IP65 IP44 Plug	48kg	2- 205x165x7,5cm 2- 305x133x7,5cm	INC.	25mm

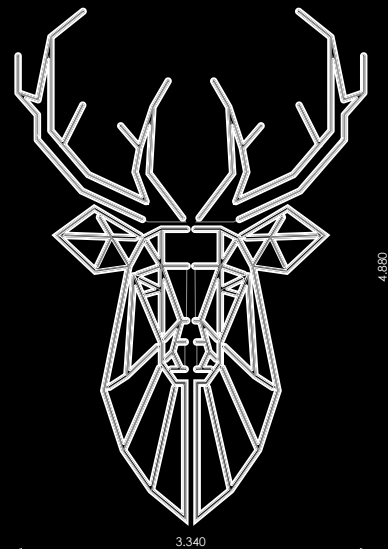

# Reindeer Face

COLECCIÓN STRAIGHT



A



B



C



D





CC. Nervión Plaza - Sevilla

# 3D Tree

## COLECCIÓN STRAIGHT



Motivo  
Motifs  
Motifs  
Motivos

3D

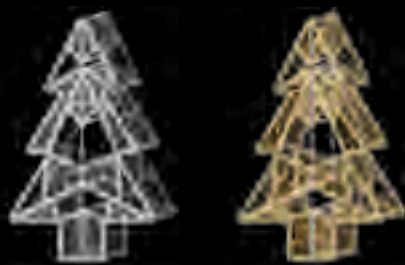

A

B



			1	2
509633	A	flexi LED	STRING PLUS LED	PVC NET
509664	B	flexi LED	STRING PLUS LED	PVC NET
W	⚡	⚡	⚡	⚡
115W	24V	CIII	IP65 IP44 Plug	23kg
			218x132x27cm	INC.
				10mm

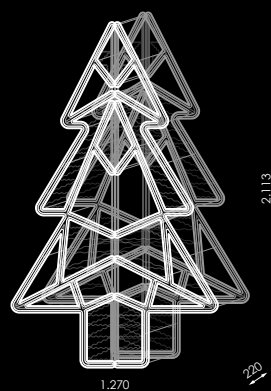

# 3D Cone

## COLECCIÓN STRAIGHT



Motivo  
Motifs  
Motifs  
Motivos

3D

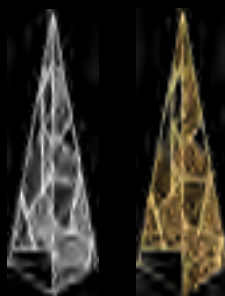

A

B



			1	2
509619	A	flexi LED	STRING PLUS LED	PVC NET
509640	B	flexi LED	STRING PLUS LED	PVC NET
W	⚡	⚡	⚡	⚡
60W	24V	CIII	IP65 IP44 Plug	14,5kg
			255x70x70cm	INC.
				10mm

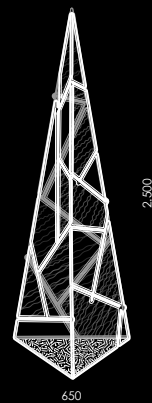



# 3D Pine Forest

## COLECCIÓN STRAIGHT

3D

Motivo  
Motifs  
Motifs  
Motivos

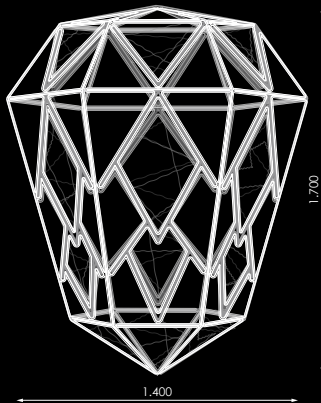
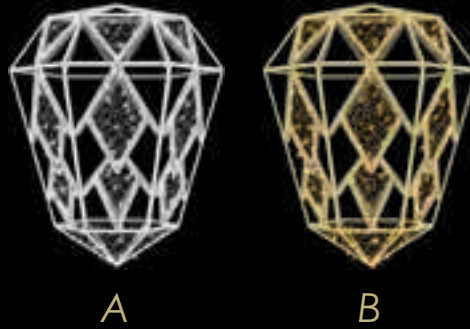

			1	2			
509626	A	flexi LED	STRING PLUS LED	PVC NET			
509657	B	flexi LED	STRING PLUS LED	PVC NET			
W	⚡	☐	⊙	⚖	🏠	🔌	📏
304W	230V	CII	IP65 IP44 Plug	38kg	175x145x145cm	INC.	10mm



[GRÁFICOS: Unidades en mm/ GRÁFICOS: Units in mm/ GRÁFICOS: Unités en mm/ GRÁFICOS: Unidades em mm]

# *Colección Toy*

---

*Cubes*

*Soldier*

*Doll*

*Train*

*Horse*

*3D Cubes*

*3D Soldier*

*3D Doll*

*3D Train*

*3D Horse*





# Cubes

COLECCIÓN TOY



Motivo  
Mofifs  
Mofifs  
Mofivos



A



B

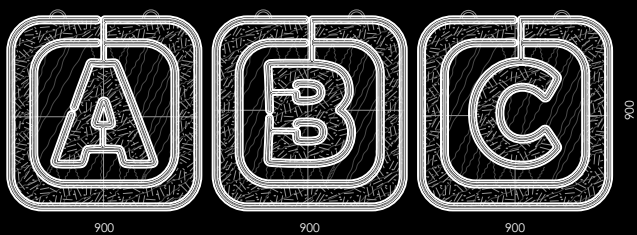

			1	2	3
509541	A	flexi LED	STRING PLUS LED LED	TAPIZ	PVC NET
509565	B	flexi LED	STRING PLUS LED LED	TAPIZ	PVC NET

W	⚡	□	⊕	⚖	📦	🔌	📏
125W	230V	CII	IP65 IP44 Plug	21.5kg	(3x) 95x95x5cm	INC.	10mm

[GRÁFICOS: Unidades en mm/ GRÁFICOS: Units in mm/GRÁFHIQUES: Unités en mm/GRÁFICOS: Unidades em mm]

# Soldier

## COLECCIÓN TOY



Motivo  
Motifs  
Motifs  
Motivos

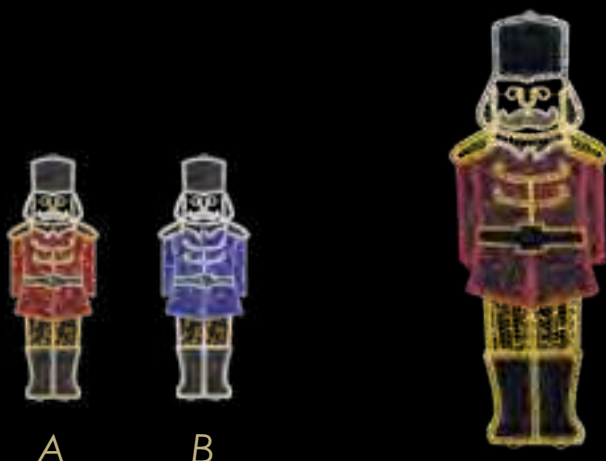

A

B

			1	2	3	
509435	A	flexi LED LED	STRING LED LED	TAPIZ	PVC NET	
509466	B	flexi LED	STRING LED LED	TAPIZ	PVC NET	
W	⚡	□	⦿	⚖	⊞	⦿
98W	230V	CII	IP65 IP44 Plug	10,5kg	216x85x5cm	INC. 10mm

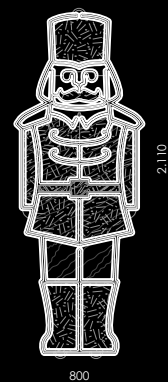

# Doll

## COLECCIÓN TOY



Motivo  
Motifs  
Motifs  
Motivos

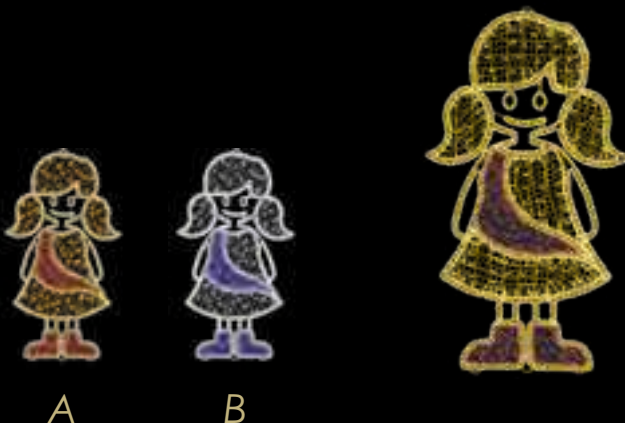

A

B

			1	2	3	
509589	A	flexi LED	STRING LED LED	TAPIZ	PVC NET	
509602	B	flexi LED	STRING LED LED	TAPIZ	PVC NET	
W	⚡	□	⦿	⚖	⊞	⦿
92W	230V	CII	IP65 IP44 Plug	9,5kg	185x106x5cm	INC. 10mm

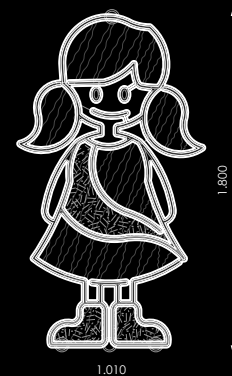



# Train

## COLECCIÓN TOY



Motivo  
Motifs  
Motifs  
Motivos



A

B

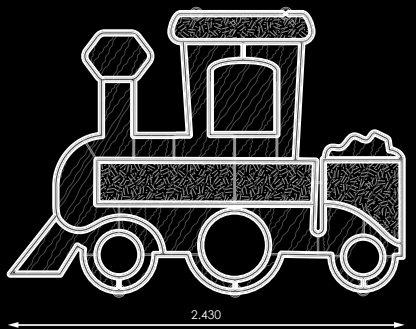

			1	2	3		
509480	A	flexi LED	STRING	LED LED LED	TAPIZ PVC NET		
509527	B	flexi LED	STRING	LED LED LED	TAPIZ PVC NET		
W	⚡	□	⊕	⚖	📏	🔌	📐
166W	230V	CII	IP65 IP44 Plug	18kg	248x178x5cm	INC.	10mm



# Horse

## COLECCIÓN TOY



Motivo  
Motifs  
Motifs  
Motivos



A

B

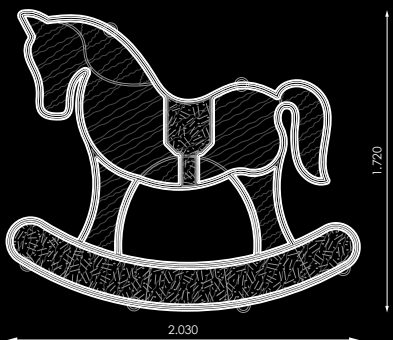

			1	2	3		
509398	A	flexi LED	STRING	LED LED LED	TAPIZ PVC NET		
509428	B	flexi LED	STRING	LED LED LED	TAPIZ PVC NET		
W	⚡	□	⊕	⚖	📏	🔌	📐
108W	230V	CII	IP65 IP44 Plug	13kg	208x177x5cm	INC.	10mm





# 3D Cubes

COLECCIÓN TOY

3D

Motivo  
Mofifs  
Mofifs  
Mofivos



A



B

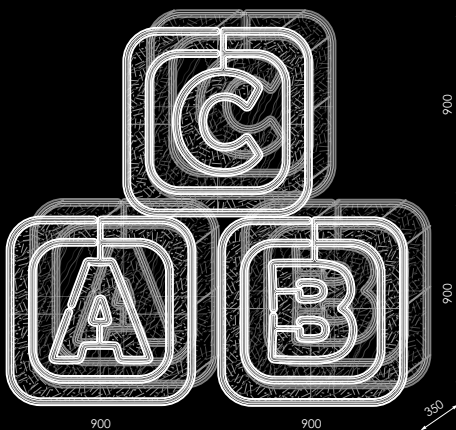

			1	2	3
509534	A	flexi LED	STRING PLUS LED LED	TAPIZ	PVC NET
509558	B	flexi LED	STRING PLUS LED LED	TAPIZ	PVC NET

W	⚡	⚠	⚙	⚖	📦	🔌	📏
195W	24V	CIII	IP65 IP44 Plug	50.5kg	(3x) 95x95x40cm	INC.	10mm

[GRÁFICOS: Unidades en mm/ GRÁFICOS: Units in mm/ GRÁFICOS: Unités en mm/ GRÁFICOS: Unidades em mm]

# 3D Soldier

## COLECCIÓN TOY



Motivo  
Motifs  
Motifs  
Motivos

3D



A



B



			1	2	3		
509459	A	flexi LED LED	STRING LED LED	TAPIZ	PVC NET		
509442	B	flexi LED	STRING LED LED	TAPIZ	PVC NET		
W	⚡	⚡	⚡	⚡	⚡	⚡	
110W	24V	CIII	IP65 IP44 Plug	23kg	216x85x27cm	INC.	10mm

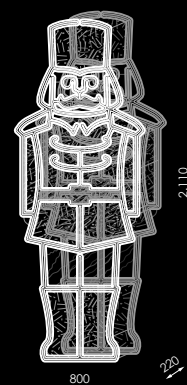

# 3D Doll

## COLECCIÓN TOY



Motivo  
Motifs  
Motifs  
Motivos

3D



A



B



			1	2	3		
509572	A	flexi LED	STRING LED LED	TAPIZ	PVC NET		
509596	B	flexi LED	STRING LED LED	TAPIZ	PVC NET		
W	⚡	⚡	⚡	⚡	⚡	⚡	
110W	24V	CIII	IP65 IP44 Plug	21kg	185x106x27cm	INC.	10mm

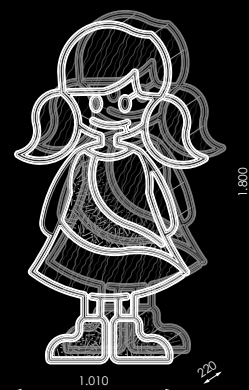



# 3D Train

COLECCIÓN TOY

3D

Motivo  
Motifs  
Motifs  
Motivos



A

B

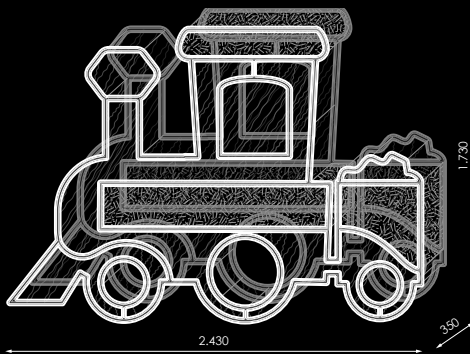

			1	2	3
509473	A	flexi LED	STRING	LED LED LED	TAPIZ PVC NET
509510	B	flexi LED	STRING	LED LED LED	TAPIZ PVC NET
W	⚡	⚡	⚡	⚡	⚡
230W	24V	CIII	IP65 IP44 Plug	37kg	248x178x40cm INC. 10mm



# 3D Horse

COLECCIÓN TOY

3D

Motivo  
Motifs  
Motifs  
Motivos



A

B

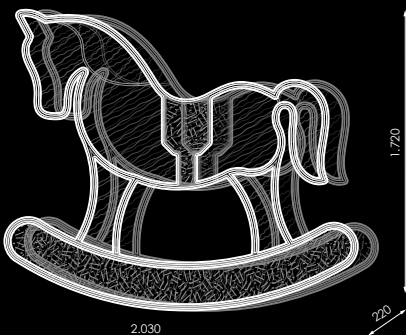

			1	2	3
509381	A	flexi LED	STRING	LED LED LED	TAPIZ PVC NET
509404	B	flexi LED	STRING	LED LED LED	TAPIZ PVC NET
W	⚡	⚡	⚡	⚡	⚡
150W	24V	CIII	IP65 IP44 Plug	30kg	208x177x27cm INC. 10mm

[GRÁFICOS: Unidades en mm/ GRÁFICOS: Units in mm/ GRÁFHIQUES: Unités en mm/ GRÁFICOS: Unidades em mm]

# *Colección Curly*

---

*Bird*

*Star*

*Ball*

*Small Butterfly*

*Ball 3D*

*Cone 3D*

*Hoop 3D*

*Hoop 3D Screenlight*

*Papyre*

*Medusa*







# Bird

COLECCIÓN CURLY



Motivo  
Motifs  
Motifs  
Motivos



A



B



C



2.792

1.594

Barcode	Model	Light Type	Power (W)
480338	A	flexi LED	130W
480383	B	flexi LED	130W
478694	C	flexi LED	184W

⚡	□	⚙️	⚖️	📦	🔌	📏
230V	CII	IP65 IP44 Plug	11kg	160x300x6cm	INC.	10mm

[GRÁFICOS: Unidades en mm/ GRAFICS: Units in mm/ GRAFIQUES: Unités en mm/ GRAFICOS: Unidades em mm]

# Star

COLECCIÓN CURLY



Motivo  
Motifs  
Motifs  
Motivos



A



B



C



Barcode	Option	Light Type	Power (W)
480345	A	flexi LED	100W
480390	B	flexi LED	100W
478700	C	flexi LED	142,6W

230V	CII	IP65 IP44 Plug	8kg	210x210x6cm	INC.	10mm





# Ball

## COLECCIÓN CURLY



Motivo  
Motifs  
Motifs  
Motivos



A



B



C



Barcode	Model	LED Type	Power (W)
480352	A	flexiLED	130W
480406	B	flexiLED	130W
478717	C	flexiLED	184W

⚡	□	⚙️	⚖️	📦	🔌	📏
230V	CII	IP65 IP44 Plug	11kg	220x205x6cm	INC.	10mm

[GRÁFICOS: Unidades en mm/ GRÁFICOS: Units in mm/GRÁFICOS: Unités en mm/GRÁFICOS: Unidades em mm]

# Small Butterfly

COLECCIÓN CURLY



Motivo  
Motifs  
Motifs  
Motivos



A



B



C



Barcode	Model	Material	Power (W)
480321	A	flexi LED	105W
480376	B	flexi LED	105W
478687	C	flexi LED	151,8W

230V	CII	IP65 IP44 Plug	9kg	190x160x6cm	INC.	10mm





# Ball 3D

COLECCIÓN CURLY



Motivo  
Motifs  
Motifs  
Motivos

3D



			W
509701	A	flexi	219W
509749	B	flexi	219W
512084	C	flexi	336W

230V	CII	IP65 IP44 Plug	20,5kg	(2x) 135x135x70cm (1x) 129x58x7cm	INC.	10mm

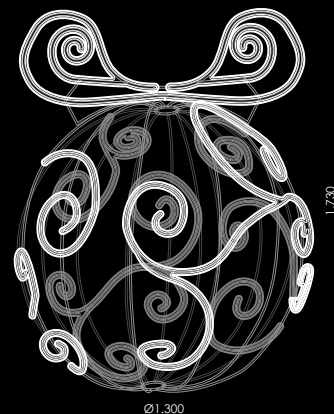



# Cone 3D

## COLECCIÓN CURLY

3D

Motivo  
Motifs  
Motifs  
Motivos

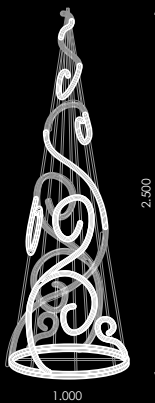
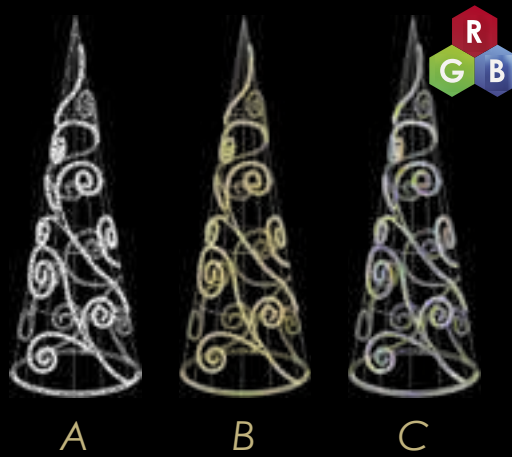

[GRÁFICOS: Unidades en mm/ GRÁFICOS: Units in mm/ GRÁFICOS: Unités en mm/ GRÁFICOS: Unidades em mm]

Barcode	Model	Light Type	Power (W)	Voltage (V)
509671	A	flexi LED	100W	24V
509718	B	flexi LED	100W	24V
512053	C	flexi LED	317W	230V

Icon: Square	Icon: Plug	Icon: Weight	Icon: Box	Icon: Plug	Icon: Square
CII	IP65 IP44 Plug	19kg	255x105x105cm	INC.	10mm

# Hoop 3D

COLECCIÓN CURLY



Motivo  
Motifs  
Motifs  
Motivos

3D



A



B



C



Barcode	Model	Material	Power (W)
509688	A	flexi LED	162W
509725	B	flexi LED	162W
512060	C	flexi LED	248W

230V	CII	IP65 IP44 Plug	21kg	130x130x65cm	INC.	10mm

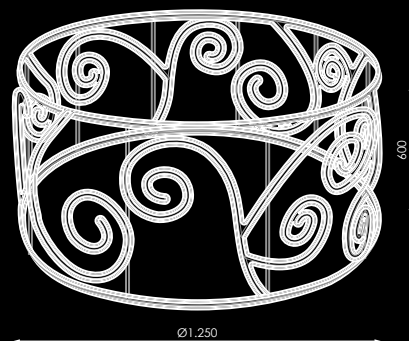





# Hoop 3D Screenlight

COLECCIÓN CURLY

3D

Motivo  
Motifs  
Motifs  
Motivos

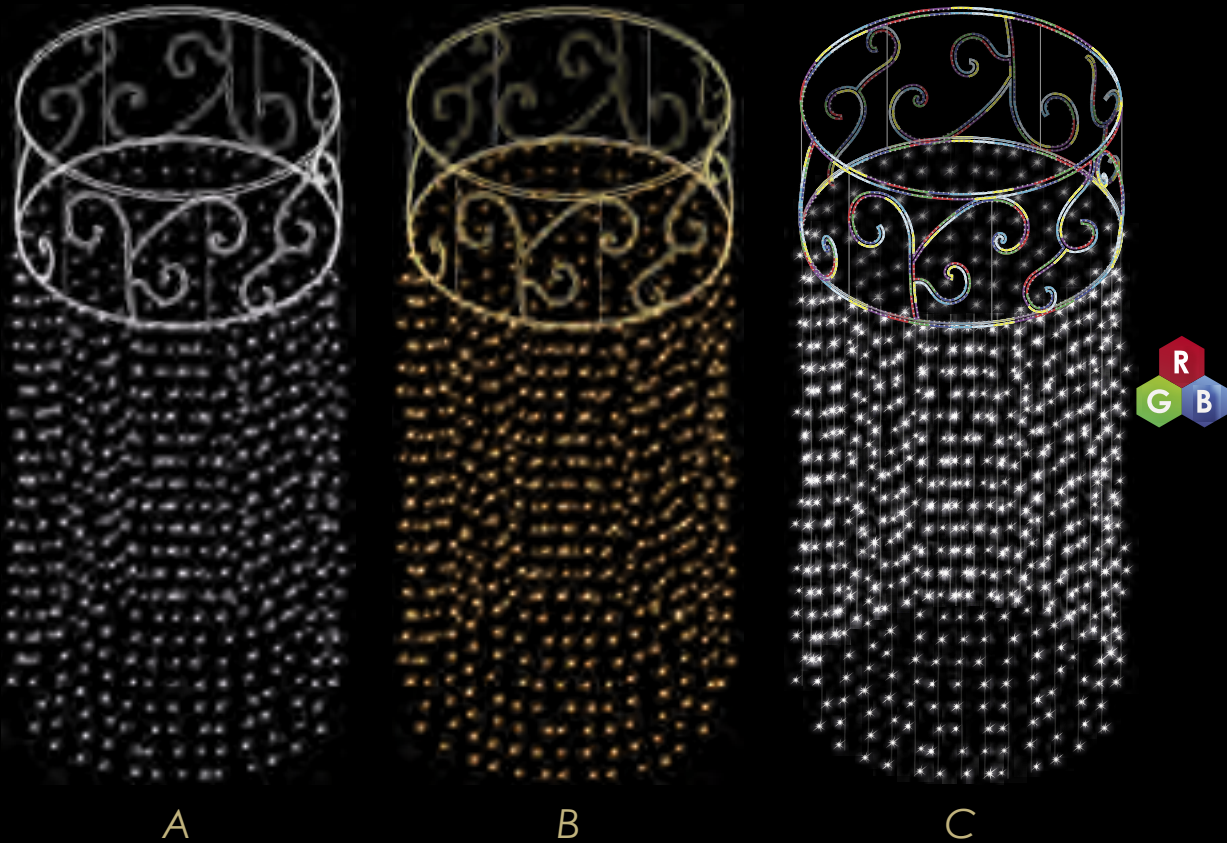

				W
509695	A	flexi LED	SCREENLIGHT LED	204W
509732	B	flexi LED	SCREENLIGHT LED	204W
512077	C	flexi LED	SCREENLIGHT LED	290W
⚡	□	⦿	⚖	📏
230V	CII	IP65 IP44 Plug	21,5kg	130x130x65cm INC. 10mm

[GRÁFICOS: Unidades en mm/ GRÁFICOS: Units in mm/ GRAPHIQUES: Unités en mm/ GRÁFICOS: Unidades em mm]

# Medusa

COLECCIÓN CURLY



Motivo  
Motifs  
Motifs  
Motivos

3D



Barcode	Model	Light Source	Quantity	Power (W)
446662	A	flexi LED	4	328W
446679	B	flexi LED	4	328W
510622	C	flexi LED	4	448W

Voltage	Control	Protection	Weight	Dimensions	Installation
230V	CII	IP65 IP44 Plug	30kg	(2x) 236x115x5cm (1x) 30x30x30cm	INC.

Barcode	Model	Light Source	Quantity	Power (W)
446709	A	flexi LED	8	656W
446716	B	flexi LED	8	656W
510653	C	flexi LED	8	853W

Voltage	Control	Protection	Weight	Dimensions	Installation
230V	CII	IP65 IP44 Plug	48kg	(4x) 236x115x9cm (1x) 30x30x30cm	INC.

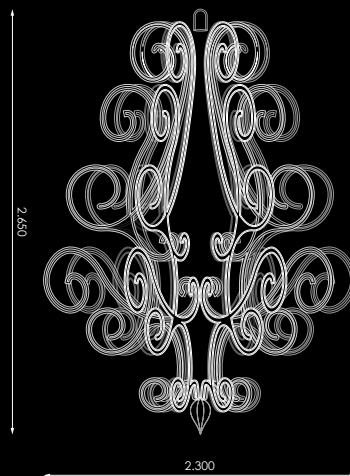



# Papyre

## COLECCIÓN CURLY

3D

Motivo  
Motifs  
Motifs  
Motivos

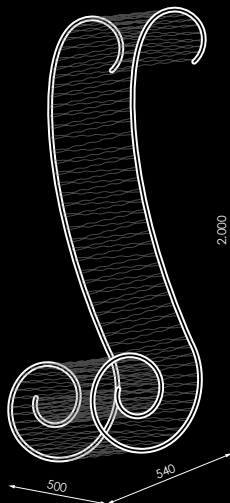

446099	flexi	STRING				
446105	flexi	STRING				
<b>W</b>						
44W	230V	CII	IP65 IP44 Plug	7kg	200x54x50cm	INC.

[GRÁFICOS: Unidades en mm/ GRÁFICOS: Units in mm/ GRAPHIQUES: Unités en mm/ GRÁFICOS: Unidades em mm]

# *Colección Fantasy*

---

*Big Ball*  
*Small Ball*  
*Big Star*  
*Small Star*  
*Big Star 3D*  
*Small Star 3D*  
*Naida*



[GRÁFICOS: Unidades en mm/ GRÁFICOS: Units in mm/GRÁFICOS: Unidades em mm/GRÁFICOS: Unidades em mm]

CC. As Cancelas -  
Santiago de Compostela

# Big Ball

COLECCIÓN FANTASY



Motivo  
Motifs  
Motifs  
Motivos



A



B



C



			1	2	W
479332	A	flexi LED	STRING PLUS LED	PVC NET	108W
479370	B	flexi LED	STRING PLUS LED	PVC NET	108W
479417	C	flexi LED	STRING PLUS LED	PVC NET	150W

230V	CII	IP65 IP44 Plug	16kg	200x200x6cm	INC.	10mm

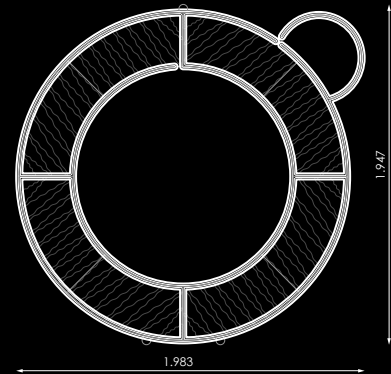

# Small Ball

COLECCIÓN FANTASY



Motivo  
Motifs  
Motifs  
Motivos



A



B



C



			1	2	W
479349	A	flexi LED	STRING PLUS LED	PVC NET	84W
479387	B	flexi LED	STRING PLUS LED	PVC NET	84W
479424	C	flexi LED	STRING PLUS LED	PVC NET	117W

230V	CII	IP65 IP44 Plug	11kg	160x160x6cm	INC.	10mm



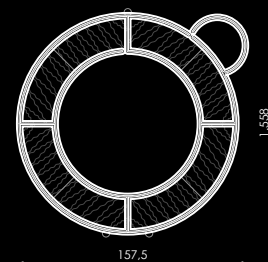

# Big Star

## COLECCION FANTASY



Motivo  
Motifs  
Motifs  
Motivos

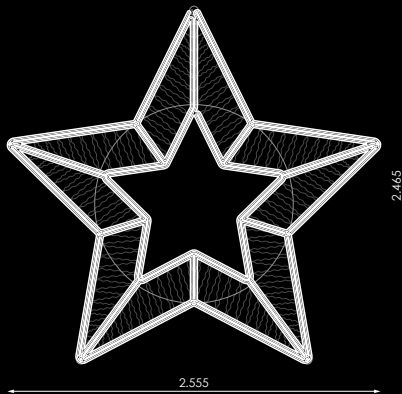

			1	2	W
479356	A	flexi LED	STRING PLUS LED	PVC NET	148W
479394	B	flexi LED	STRING PLUS LED	PVC NET	148W
479431	C	flexi LED	STRING PLUS LED	PVC NET	206W

230V	CII	IP65 IP44 Plug	21kg	260x260x6cm	INC.	10mm



# Small Star

## COLECCIÓN FANTASY



Motivo  
Motifs  
Motifs  
Motivos

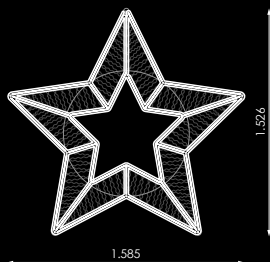

			1	2	W
479363	A	flexi LED	STRING PLUS LED	PVC NET	82W
479400	B	flexi LED	STRING PLUS LED	PVC NET	82W
479448	C	flexi LED	STRING PLUS LED	PVC NET	118W

230V	CII	IP65 IP44 Plug	11kg	170x170x6cm	INC.	10mm

# Big Star 3D

COLECCIÓN FANTASY



**N** Nuevo  
New  
Nouveau  
Novo

Motivo  
Motifs  
Motifs  
Motivos

3D



A



B



C



D



Barcode	Code	Color	Material	Light Type	Light Color	Light Type	Light Color	Material
565028	A	flexi LED	STRING PLUS	LED	LED	LED	LED	PVC NET
565042	B	flexi LED	STRING PLUS	LED	LED	LED	LED	PVC NET

  

W	⚡	□	⊕	⚖	📏	🔌	📏
290W	230V	CII	IP65 IP44 Plug	60kg	260x260x25cm	INC.	10mm

Barcode	Code	Color	Material	Light Type	Light Color	Light Type	Light Color	Material
563659	C	flexi LED	STRING PLUS	LED	LED	LED	LED	
565035	D	flexi LED	STRING PLUS	LED	LED	LED	LED	

W	⚡	□	⊕	⚖	📏	🔌	📏
290W	230V	CII	IP65 IP44 Plug	56kg	260x260x25cm	INC.	10mm



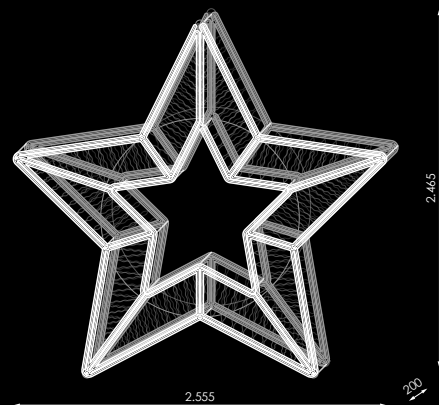



# Small Star 3D

COLECCIÓN FANTASY

Nuevo  
New  
Nouveau  
Novo

N

3D

Motivo  
Motifs  
Motifs  
Motivos



A



B



C



D

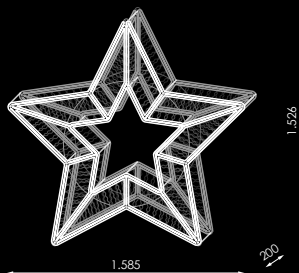

Barcode	Code	Color	Material	Light Type	Light Type
565059	A	flexi LED	STRING PLUS	LED	PVC NET
565073	B	flexi LED	STRING PLUS	LED	PVC NET

W	⚡	□	⊙	kg	📏	🔌	📏
176W	230V	CII	IP65 IP44 PLUG	34kg	170x170x25cm	INC.	10mm

Barcode	Code	Color	Material	Light Type	Light Type
563727	C	flexi LED	STRING PLUS	LED	
565066	D	flexi LED	STRING PLUS	LED	

W	⚡	□	⊙	kg	📏	🔌	📏
176W	230V	CII	IP65 IP44 PLUG	31kg	170x170x25cm	INC.	10mm

[GRÁFICOS: Unidades en mm/ GRÁFICOS: Units in mm/ GRÁFICOS: Unités en mm/ GRÁFICOS: Unidades em mm]

# Naida

COLECCIÓN FANTASY



Motivo  
Motifs  
Motifs  
Motivos

3D



	▬▬▬▬	□	■			
	446600	A	flexi LED STRING PLUS LED			
	446617	B	flexi LED STRING PLUS LED			
W	⚡	□	⦿	⚖	🕸	🔌
230W	230V	CII	IP65 IP44 Plug	40kg	(5x) 270x120x5cm (1x) 30x30x30cm	INC.

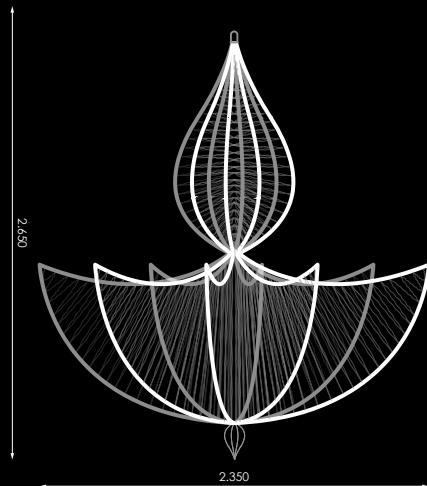







# Accesorios

Accessories  
Accessoires  
Acessórios

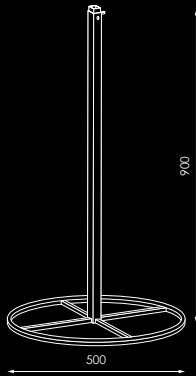
	COLECCIÓN STRAIGHT (excepto Reindeer Face y 3D)	COLECCIÓN TOY (excepto 3D)	COLECCIÓN CURLY (excepto 3D)	COLECCIÓN FANTASY (excepto 3D)
480826	•	•	•	•

## PIE VERTICAL



		
480826	 Aluminio	95~165cm

# *Colección Edén*

---

*Okra*  
*Silene*  
*Nepenthes*



# Okra

## COLECCIÓN EDÉN



Motivo  
Motifs  
Motifs  
Motivos



A

B



	544498	A	flexi
	544504	B	flexi
<b>W</b>			
6W	230V	CII	IP65 IP44 Plug
		1kg	
		43x30x5cm	
		INC.	
		10mm	



# Silene

## COLECCIÓN EDÉN



Motivo  
Motifs  
Motifs  
Motivos

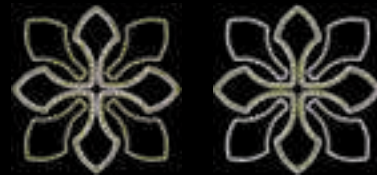

A

B

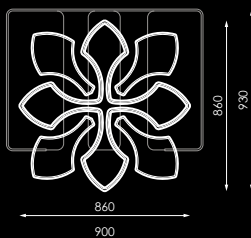

	544436	A	flexi
	544443	B	flexi
<b>W</b>			
36W	230V	CII	IP65 IP44 Plug
		3kg	
		97x95x5cm	
		INC.	
		10mm	

# Nepenthes

COLECCIÓN EDÉN



Motivo  
Motifs  
Motifs  
Motivos

3D

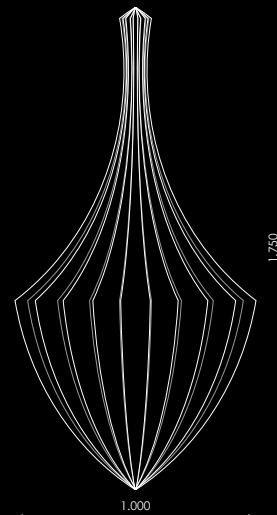

544832	A	STRING PLUS			PVC NET	
544849	B	STRING PLUS			PVC NET	
32W	230V	CII	IP65 IP44 Plug	10kg	(2x) 180x55x55cm	INC.

Bajo pedido/On request/Sur commande/A pedido



IP20



# *Colección Helix*

---

*Abolone*  
*Cingula*  
*Mitra*  
*Bolma*  
*Obba*





# Abolone

## COLECCIÓN HELIX



Motivo  
Motifs  
Motifs  
Motivos

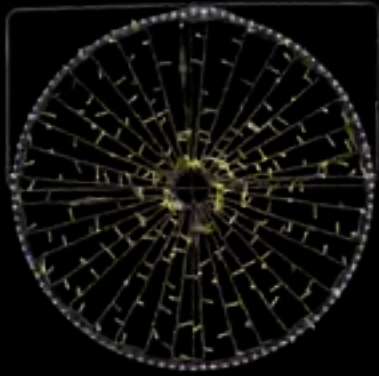

A

B

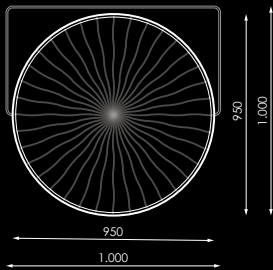

544993	A	flexi LED STRING PLUS LED					
545006	B	flexi LED STRING PLUS LED					
<b>W</b>							
25W	230V	CII	IP65 IP44 Plug	3,5kg	105x105x5cm	INC.	10mm



# Cingula

## COLECCIÓN HELIX



Motivo  
Motifs  
Motifs  
Motivos



A



B

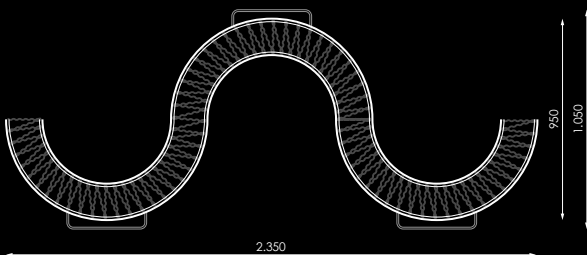

545211	A	flexi LED STRING PLUS LED					
545228	B	flexi LED STRING PLUS LED					
<b>W</b>							
44W	230V	CII	IP65 IP44 Plug	6,5kg	240x110x5cm	INC.	10mm

[GRÁFICOS: Unidades en mm/ GRÁFICOS: Units in mm/ GRÁFICOS: Unités en mm/ GRÁFICOS: Unidades em mm]



Plaza San Francisco - Zaragoza



# Mitra

## COLECCIÓN HELIX



Motivo  
Motifs  
Motifs  
Motivos

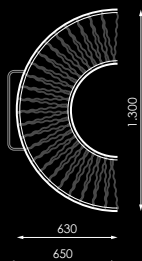
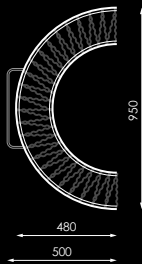

95cm						
Barcode	Model	Light Type	String	Plus	LED	LED
544870	A	flexi LED	STRING	PLUS	LED	LED
544887	B	flexi LED	STRING	PLUS	LED	LED
544894	C	flexi LED	STRING	PLUS	LED	LED
544900	D	flexi LED	STRING	PLUS	LED	LED

W	⚡	□	⊙	⚖	📦	🔌	📏
17W	230V	CII	IP65 IP44 Plug	2kg	100x55x5cm	INC.	10mm

130cm						
Barcode	Model	Light Type	String	Plus	LED	LED
544931	E	flexi LED	STRING	PLUS	LED	LED
544948	F	flexi LED	STRING	PLUS	LED	LED
544955	G	flexi LED	STRING	PLUS	LED	LED
544962	H	flexi LED	STRING	PLUS	LED	LED

W	⚡	□	⊙	⚖	📦	🔌	📏
28W	230V	CII	IP65 IP44 Plug	4kg	135x70x5cm	INC.	10mm

[GRÁFICOS: Unidades en mm/ GRÁFICOS: Units in mm/ GRÁFICOS: Unidades en mm/ GRÁFICOS: Unidades en mm]

# Bolma

COLECCIÓN HELIX



Motivo  
Motifs  
Motifs  
Motivos



95cm

545099	A	flexi LED STRING PLUS LED LED
545105	B	flexi LED STRING PLUS LED LED
W		
30W	230V	CII
IP65	IP44	Plug
3kg	105x110x5cm	INC.
		10mm

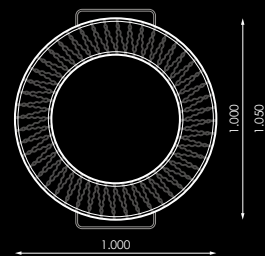

130cm

545150	C	flexi LED STRING PLUS LED LED
545167	D	flexi LED STRING PLUS LED LED
W		
49W	230V	CII
IP65	IP44	Plug
6kg	135x140x5cm	INC.
		10mm

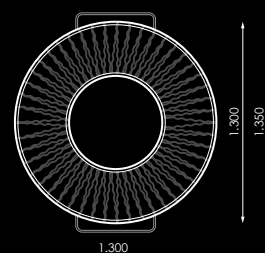



# Obba

## COLECCIÓN HELIX

3D

Motivo  
Motifs  
Motifs  
Motivos

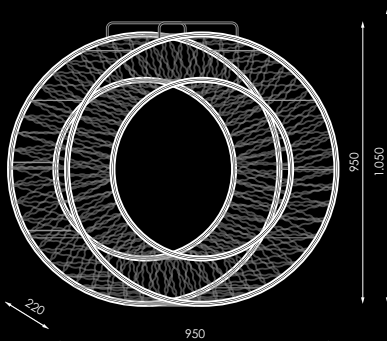

		95cm	
545273	A	flexi	STRING
545280	B	flexi	STRING
<b>W</b>			
92W	230V	CII	IP65 IP44 Plug
		10kg	110x100x27cm
		INC.	10mm

[GRÁFICOS: Unidades en mm/ GRÁFICOS: Units in mm/ GRÁFICOS: Unités en mm/ GRÁFICOS: Unidades em mm]

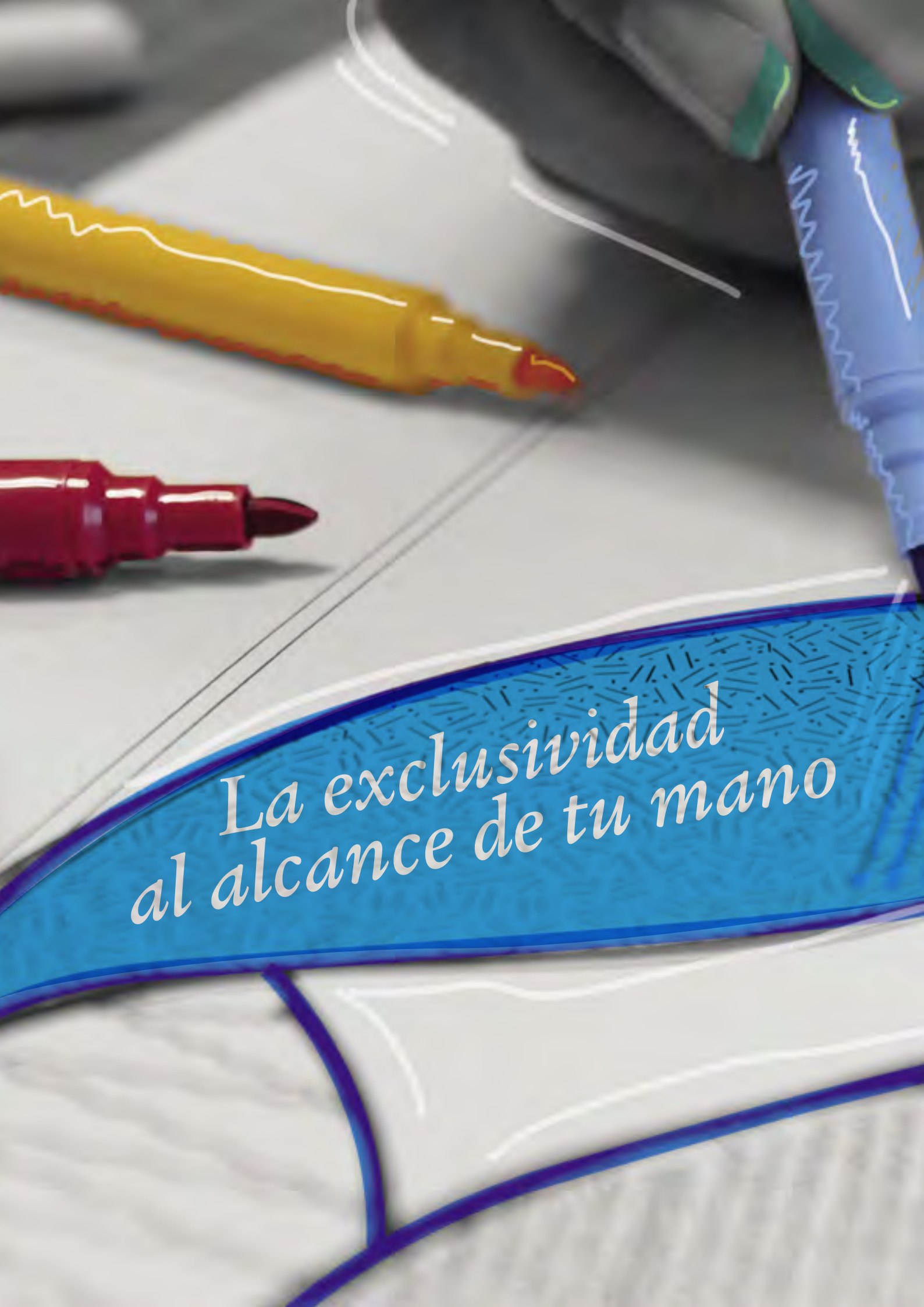

*La exclusividad  
al alcance de tu mano*

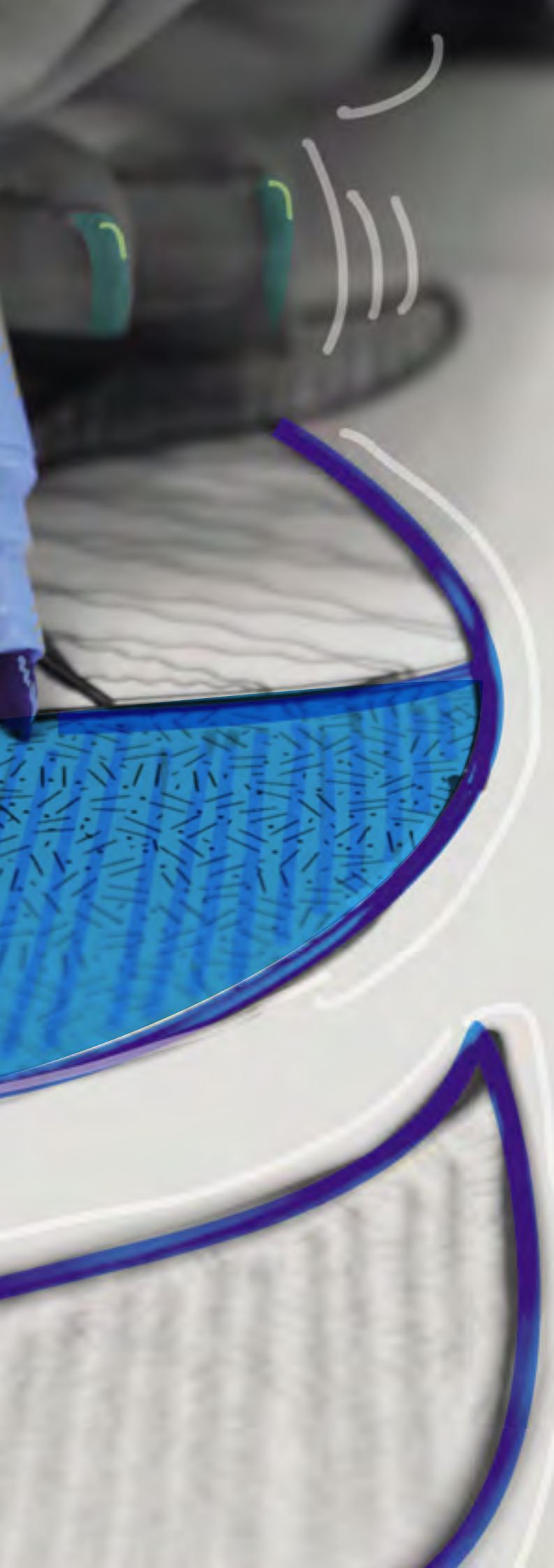

---

En prilux somos especialistas en iluminación corporativa para tu empresa, negocio, localidad...etc. Nos ajustamos al diseño de tu imagen corporativa y producimos motivos e iluminaciones con tus colores corporativos. Personalizamos tus instalaciones convirtiéndolos en espacios únicos y exclusivos con identidad propia...la tuya.

---

In prilux we are specialists in corporate lighting for your company, business, location ... etc. We fit the design of your corporate image and produce motifs and lighting with your corporate colors. We personalize your installations making them unique and exclusive spaces with your own identity ... yours.

---







Dans prilux, nous sommes spécialisés dans l'éclairage d'entreprise pour votre entreprise, entreprise, emplacement ... etc. Nous adaptons le design de votre image d'entreprise et produisons des motifs et des luminaires avec vos couleurs d'entreprise. Nous personnalisons vos installations en leur faisant des espaces uniques et exclusifs avec votre propre identité ... le vôtre.



---

Em prilux, somos especialistas em iluminação corporativa para sua empresa, empresa, localização ... etc. Ajustamos o design de sua imagem corporativa e produzimos motivos e iluminação com suas cores corporativas. Personalizamos suas instalações, tornando-os espaços exclusivos e exclusivos com sua própria identidade ... seu.









## 200cm

		
546201		
546218		

<b>W</b>						
9W	230V	CII	IP44	4kg	205x45x8cm	INC.



## 400cm

		
546225		
546232		

<b>W</b>						
15W	230V	CII	IP44	8kg	210x70x14cm	INC.



### Información/Information/Information/Informações



Ñ/ Ideal para fachadas. Iluminación solo por la parte frontal.

E/ Ideal for facades. Lighting only from the front.

F/ Idéal pour les façades. Éclairage seulement de l'avant.

P/ Ideal para fachadas. Iluminação apenas pela frente.





# Feliz Navidad

CORPOREO



200cm						
546140						
546157						
<b>W</b>						
9W	230V	CII	IP44	4kg	205x45x8cm	INC.

400cm						
546164						
546171						
<b>W</b>						
15W	230V	CII	IP44	8kg	243x75x14cm	INC.

[GRÁFICOS: Unidades en mm/ GRÁFICOS: Units in mm/ GRÁFICOS: Unidades en mm/ GRÁFICOS: Unidades en mm]



## Información/Information/Information/Informações

**Ñ**/ Ideal para fachadas. Iluminación solo por la parte frontal.

**E**/ Ideal for facades. Lighting only from the front.

**F**/ Idéal pour les façades. Éclairage seulement de l'avant.

**P**/ Ideal para fachadas. Iluminação apenas pela frente.

# Prilux te propone ser creativo.

Para ello se han diseñado una serie de motivos que te permiten combinar con otros motivos de nuestro catálogo. Fijate en el símbolo que te indica con qué motivo puedes combinarlo, y..... CREA!!!

## EJEMPLOS DE COMPOSICIÓN

COMPOSITION EXAMPLE

EXEMPLES DE COMPOSITION

EXEMPLOS DE COMPOSIÇÃO



Prilux proposes you to be creative. To do this, a series of motifs have been designed that allow you to combine with other motifs in our catalog. Look at the symbol that tells you why you can combine it, and.....CREATE !!!

Prilux vous propose d'être créatif. Pour ce faire, une série de motifs a été conçue pour vous permettre de combiner avec d'autres motifs de notre catalogue. Regardez le symbole qui vous indique pourquoi vous pouvez le combiner, et..... CREATE !!!

Prilux propõe que você seja criativo. Para fazer isso, uma série de motivos foram projetados para combinar com outros motivos em nosso catálogo. Olhe para o símbolo que lhe diz porque você pode combiná-lo e.....CRIAR !!!



# Feliz Navidad



Motivo  
Motifs  
Motifs  
Motivos

A *Feliz Navidad*

C *Feliz Navidad*

B *Feliz Navidad*

D *Feliz Navidad*



Barcode	Code	LED Type	W	kg
545372	A	flexi LED	78W	17kg
545389	B	flexi LED	78W	17kg
489072	C	flexi DOUBLE NEON LED	234W	19kg
489089	D	flexi DOUBLE NEON LED	234W	19kg

⚡	□	⊙	⊞	⊥	□
230V	CII	IP65 IP44 Plug	300x74x7,5cm	INC.	10mm



# Feliz Navidad ABETOS



Motivo  
Motifs  
Motifs  
Motivos

A *Feliz Navidad*

B *Feliz Navidad*



Barcode	Code	LED Type	W	kg
509848	A	flexi LED	TAPIZ	
509855	B	flexi LED	TAPIZ	

W	⚡	□	⊙	⊞	⊥	□	
132W	230V	CII	IP65 IP44 Plug	16kg	(2x) 97x77x5cm (2x) 30x32x5cm (1x) 51x53x5cm (1x) 99x33x5cm (1x) 305x557x5cm	INC.	10mm

# Feliz Navidad

8m



Motivo  
Motifs  
Motifs  
Motivos



Ávila

A *Feliz Navidad*

B *Feliz Navidad*



509800	A flexi						
509817	B flexi						
267W	230V	CII	IP65 IP44 Plug	30kg	350x165x20cm	INC.	20mm

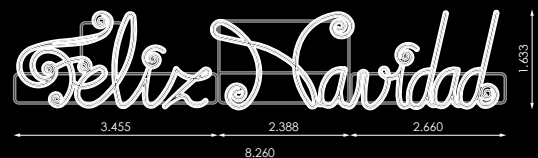



# Feliz Navidad

6m

Nuevo  
New  
Nouveau  
Novo



Motivo  
Motifs  
Motifs  
Motivos



[GRÁFICOS: Unidades en mm/ GRÁFICOS: Units in mm/ GRÁFICOS: Unités en mm/ GRÁFICOS: Unidades em mm]

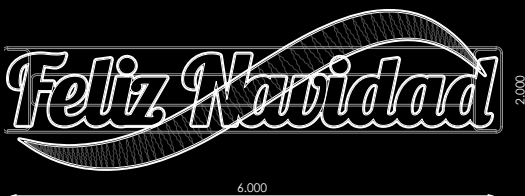

	1	2	
567152	flexi DOBLE NEON	flexi	STRING PLUS
W			
579W	230V	CII	IP65 IP44 Plug
35kg	300x200x20cm	INC.	10x20mm

# Felices Fiestas



Motivo  
Motifs  
Motifs  
Motivos



545334	A	flexi	LED
545341	B	flexi	LED

W							
48W	230V	CII	IP65 IP44 Plug	7kg	270x55x5cm	INC.	10mm



				W	
545358	A	flexi	LED	96W	24kg
545365	B	flexi	LED	96W	24kg
489096	C	flexi DOUBLE NEON	LED	288W	26kg
489102	D	flexi DOUBLE NEON	LED	288W	26kg

230V	CII	IP65 IP44 Plug	275x95x7,5cm	INC.	10mm



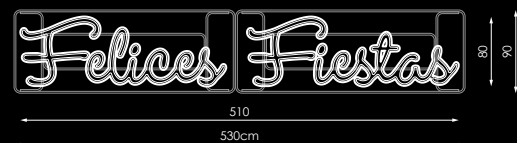

# Felices Fiestas

## ESTRELLAS 6m

Nuevo  
New  
Nouveau  
Novo

N



Motivo  
Motifs  
Motifs  
Motivos



567169	flexi DOBLE NEON	STRING PLUS
W		
368W	230V	CII
IP65	38kg	300x220x20cm
IP44 Plug	INC.	10x20mm

[GRÁFICOS: Unidades en mm/ GRÁFICOS: Units in mm/ GRÁFICOS: Unités en mm/ GRÁFICOS: Unidades em mm]

# Felices Fiestas

CON ESTRELLA DE MAR



Motivo  
Motifs  
Motifs  
Motivos



	1	2	T
149358	A	flexi LED	FLASH BULB
149372	B	flexi LED	FLASH BULB
W	⚡	□	⊙
73W	230V	CII	IP65 IP44 Plug
		8kg	270x83x5cm
			INC. 10mm



	1	2	T
149365	A	flexi LED	FLASH BULB
149389	B	flexi LED	FLASH BULB
W	⚡	□	⊙
120W	230V	CII	IP65 IP44 Plug
		26kg	275x173x7.5cm
			INC. 25mm

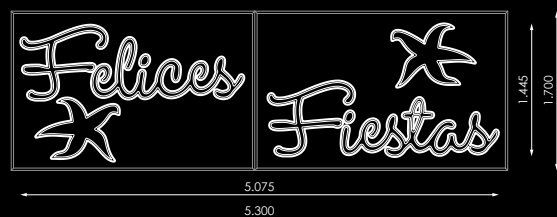





# Felices Fiestas

## CON ESTRELLAS y BOLAS



Motivo  
Motifs  
Motifs  
Motivos



149396	flexi LED	CHRISTMAS BALL

<b>W</b>							
57W	230V	CII	IP65 IP44 Plug	8kg	270x84x5cm	INC.	10mm

149402	flexi LED	CHRISTMAS BALL

<b>W</b>							
116W	230V	CII	IP65 IP44 Plug	23kg	275x150x7,5cm	INC.	25mm

[GRÁFICOS: Unidades en mm/ GRÁFICOS: Units in mm/ GRÁFICOS: Unidades en mm/ GRÁFICOS: Unidades en mm]

# Felices Fiestas

## CON COMETA



Motivo  
Motifs  
Motifs  
Motivos



Moralzarzal - Madrid



1		2	
149426		flexi LED	
W	⚡	□	⊙
78W	230V	CII	IP65 IP44 Plug
⚖	⊞	⚙	⊞
8kg	270x84x5cm	INC.	10mm



1		2	
149419		flexi LED	
W	⚡	□	⊙
156W	230V	CII	IP65 IP44 Plug
⚖	⊞	⚙	⊞
26kg	275x173x7.5cm	INC.	25mm





# Felices Fiestas

## RAMA



Motivo  
Motifs  
Motifs  
Motivos

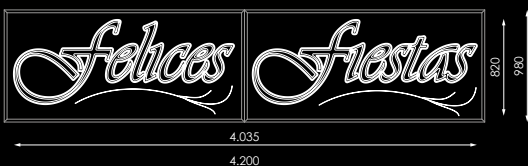

		1	2
149488	A	flexi LED	flexi LED
149471	B	flexi LED	flexi LED

W	⚡	□	⊙	⚖	📦	🔌	📏
66W	230V	CII	IP65 IP44 Plug	4kg	258x63x5cm	INC.	10mm

		1	2
149501	A	flexi LED	flexi LED
149495	B	flexi LED	flexi LED

W	⚡	□	⊙	⚖	📦	🔌	📏
120W	230V	CII	IP65 IP44 Plug	18kg	220x100x7,5cm	INC.	25mm

# Felices Fiestas



Motivo  
Motifs  
Motifs  
Motivos



Ayto. Zizur - Pamplona



A *Felices Fiestas* B *Felices Fiestas*

385046	A flexi
094863	B flexi
<b>W</b>	
40W	230V CII IP65 IP44 Plug 4kg 209x40x5cm INC. 10mm



385053	A flexi
094788	B flexi
<b>W</b>	
56W	230V CII IP65 IP44 Plug 8kg 313x58x5cm INC. 25mm





# Bones Festes

## CON COMETA



Motivo  
Motifs  
Motifs  
Motivos

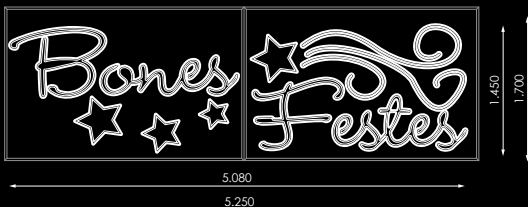

	1	2					
385695	flexi LED	flexi LED					
W							
78W	230V	CII	IP65 IP44 Plug	8kg	270x84x5cm	INC.	10mm

	1	2					
385701	flexi LED	flexi LED					
W							
156W	230V	CII	IP65 IP44 Plug	26kg	264x173x7,5cm	INC.	25mm

[GRÁFICOS: Unidades en mm/ GRÁFICOS: Units in mm/ GRÁFICOS: Unidades en mm/ GRÁFICOS: Unidades en mm/ GRÁFICOS: Unidades en mm]

# Bones Festes

## RAMA



Motivo  
Motifs  
Motifs  
Motivos



		1	2
385657	A	flexi LED	flexi LED
385664	B	flexi LED	flexi LED

W	⚡	□	⊕	⚠	⊞	☰	□
62W	230V	CII	IP65 IP44 Plug	7kg	260x63x5cm	INC.	10mm



		1	2
385671	A	flexi LED	flexi LED
385688	B	flexi LED	flexi LED

W	⚡	□	⊕	⚠	⊞	☰	□
100W	230V	CII	IP65 IP44 Plug	18kg	220x100x7,5cm	INC.	25mm

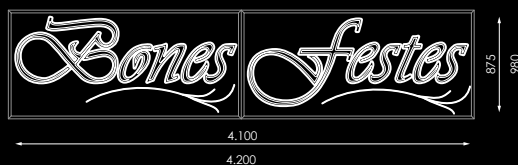



# Bones Festes

## FREESTYLE



Motivo  
Mofifs  
Mofifs  
Mofivos

A BONES FESTES

B BONES FESTES



385084	A flexi
954273	B flexi

<b>W</b>							
66W	230V	CII	IP65 IP44 Plug	4kg	270x50x5cm	INC.	10mm

373821	A flexi
954280	B flexi

<b>W</b>							
90W	230V	CII	IP65 IP44 Plug	14,5kg	213x70x7,5cm	INC.	25mm







# Boas Festas

FREESTYLE



Motivo  
Mofifs  
Mofifs  
Mofivos

A BOAS FESTAS  
B BOAS FESTAS



385077	A flexi LED
961578	B flexi LED
<b>W</b>	
81W	230V CII
IP65	13,5kg
IP44 Plug	235x70x7,5cm
INC.	25mm



# Boas Festas

6m

Nuevo  
New  
Nouveau  
Novo

N



Motivo  
Mofifs  
Mofifs  
Mofivos

A BOAS FESTAS  
B BOAS FESTAS



567176	A flexi DOBLE NEON LED
567183	B flexi DOBLE NEON LED
<b>W</b>	
477W	230V CII
IP65	30kg
IP44 Plug	390x130x7,5cm
INC.	10x20mm



		1	2
385718	A	flexi LED	flexi LED
385725	B	flexi LED	flexi LED

W	⚡	□	⊕	⚠	⊞	☰	□
43W	230V	CII	IP65 IP44 Plug	4kg	185x63x5cm	INC.	10mm

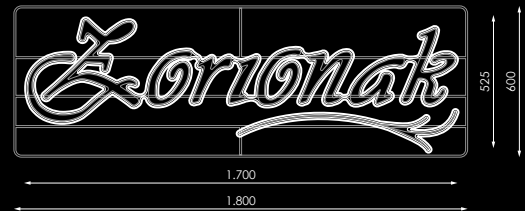

		1	2
385732	A	flexi LED	flexi LED
385749	B	flexi LED	flexi LED

  

W	⚡	□	⊕	⚠	⊞	☰	□
67W	230V	CII	IP65 IP44 Plug	10kg	293x100x5cm	INC.	10mm





[GRÁFICOS: Unidades en mm/ GRÁFICOS: Units in mm/ GRAPHIQUES: Unités en mm/ GRÁFICOS: Unidades em mm]

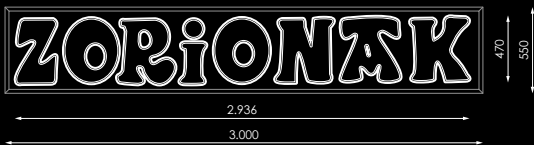

Barcode	Model	Light Type	W	kg
389556	A	flexi LED	47,5W	10kg
193313	B	flexi LED	47,5W	10kg
489119	C	flexi DOUBLE NEON LED	270W	18kg
489126	D	flexi DOUBLE NEON LED	270W	18kg

⚡	□	⊙	⊞	⌚	□
230V	CII	IP65 IP44 Plug	303x57x5cm	INC.	25mm

Barcode	Model	Light Type
544276	A	flexi LED
544269	B	flexi LED

W	⚡	□	⊙	kg	⊞	⌚	□
90W	230V	CII	IP65 IP44 Plug	16kg	300x95x7,5cm	INC.	25mm

# Merry Christmas



Motivo  
Motifs  
Motifs  
Motivos



A Merry Christmas

B Merry Christmas



		<input type="checkbox"/>
545396	A	flexi LED
545402	B	flexi LED
	60W   230V   CII   IP65 IP44 Plug   10kg   200x70x7,5cm   INC.   10mm	



# Merry Christmas



Motivo  
Motifs  
Motifs  
Motivos



A Merry Christmas

B Merry Christmas



		<input type="checkbox"/>
509862	A	flexi LED
509879	B	flexi LED
	111W   230V   CII   IP65 IP44 Plug   14,5kg   256x115x10cm   INC.   10mm	





# Bonnes Fêtes

## CON COMETA

Nuevo  
New  
Nouveau  
Novo

N



Motivo  
Motifs  
Motifs  
Motivos

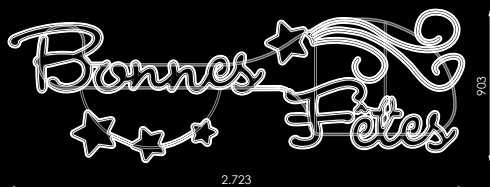

	1	2					
494885	flexi LED	flexi LED					
W							
81W	230V	CII	IP65 IP44 Plug	8,5kg	277x907x7,5cm	INC.	10mm

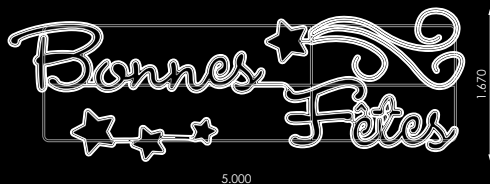

	1	2					
526159	flexi LED	flexi LED					
W							
165W	230V	CII	IP65 IP44 Plug	26kg	264x173x7,5cm	INC.	10x20mm

[GRÁFICOS: Unidades en mm/ GRÁFICOS: Units in mm/ GRÁFICOS: Unidades en mm/ GRÁFICOS: Unidades en mm]

# Bonne Année

## RAMA



**N** Nuevo  
New  
Nouveau  
Novo

Motivo  
Motifs  
Motifs  
Motivos



Bonne Année



	1	2
526166	flexi LED	flexi LED
W	⚡	⊞
69W	230V	CII
	IP65 IP44 Plug	7,5kg
	256x63x5cm	INC.
		20x10mm



	1	2
528047	flexi LED	flexi LED
W	⚡	⊞
102W	230V	CII
	IP65 IP44 Plug	12kg
	266x95x10cm	INC.
		20x10mm





# Joyeux Noël

Nuevo  
New  
Nouveau  
Novo

N



Motivo  
Motifs  
Motifs  
Motivos

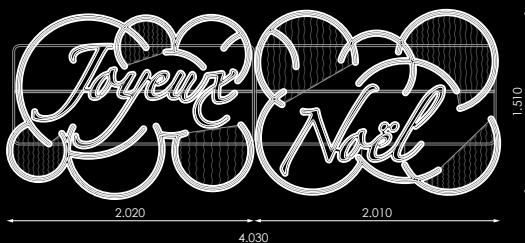

	1	2					
526180	flexi LED	flexi LED	STRING PLUS LED				
W							
186W	230V	CII	IP65 IP44 Plug	23,5kg	207x156x7,5cm	INC.	10mm

[GRÁFICOS: Unidades en mm/ GRÁFICOS: Units in mm/ GRÁFICOS: Unités en mm/ GRÁFICOS: Unidades em mm]

# Star Comet

## 550cm



Motivo  
Motifs  
Motifs  
Motivos

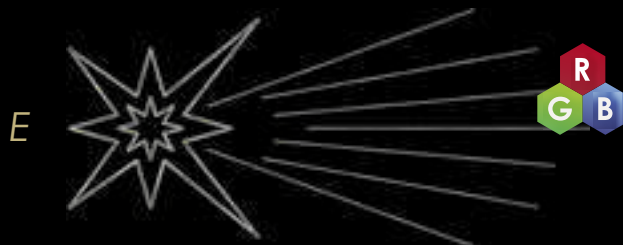
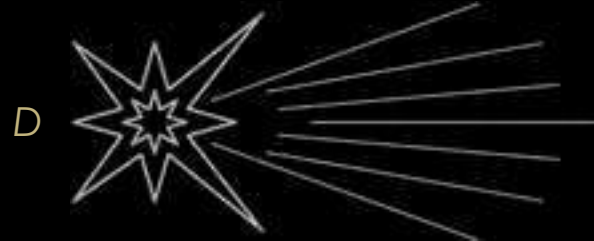

Barcode	Model	Lighting Technology	Power (W)
392389	A	flexi LED	236W
392419	B	flexi LED / CLUSTER LED	70W
392433	C	flexi LED	178W
392426	D	flexi LED	178W
488716	E	flexi LED	280W



Cambio entre colores según función seleccionada.  
Switching between colors according to selected function.  
La commutation entre les couleurs en fonction de la fonction sélectionnée.  
Alternando entre as cores de acordo com a função seleccionada.

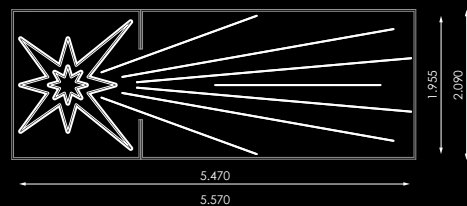

230V	CII	IP65 IP44 Plug	25kg	1- 362x204x6cm 2- 162x204x6cm	INC.	25mm





# Star Comet

## 700cm



Motivo  
Motifs  
Motifs  
Motivos

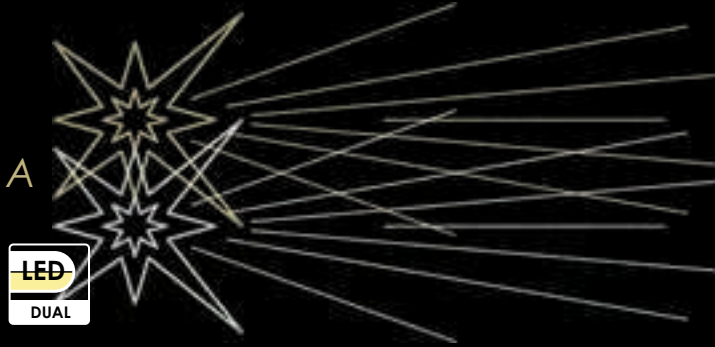

A



B

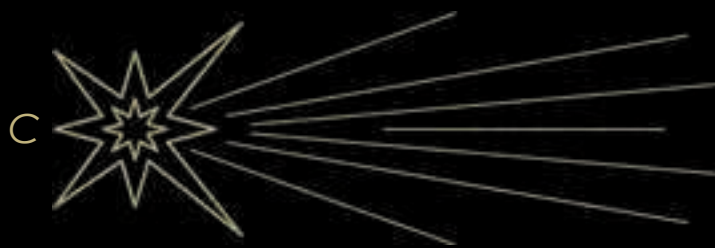

C

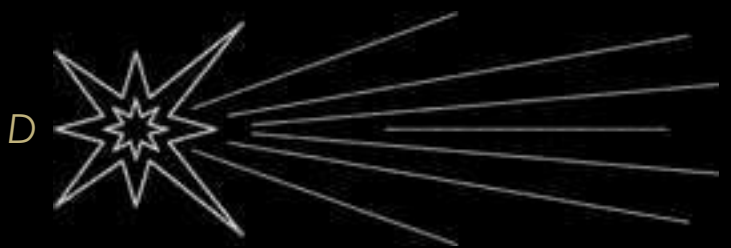

D

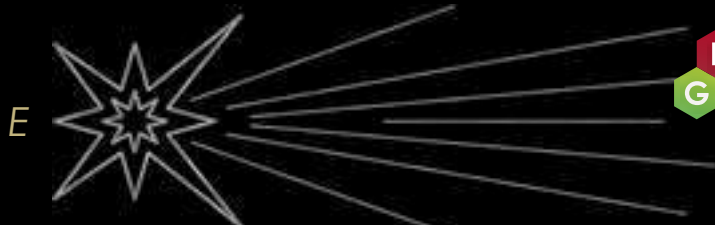

E

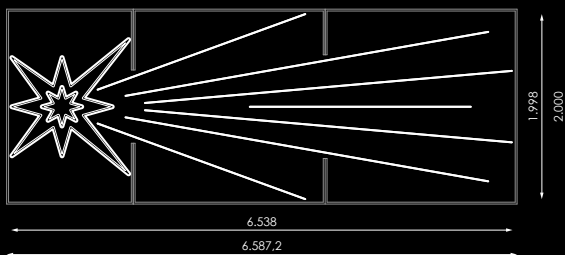

			W
209205	A	flexi LED	305W
240437	B	flexi LED / CLUSTER LED	78W
209243	C	flexi LED	218W
209236	D	flexi LED	218W
488723	E	flexi LED	368W



Cambio entre colores según función seleccionada.  
Switching between colors according to selected function.  
La commutation entre les couleurs en fonction de la fonction sélectionnée.  
Alternando entre as cores de acordo com a função seleccionada.

230V	CII	IP65 IP44 Plug	28kg	1- 275x205x6cm 2- 162x205x6cm	INC.	25mm

# Portada Spheres



Motivo  
Motifs  
Motifs  
Motivos



487993	flexi LED	flexi LED	SPHERE 3D CW			
434W	230V	CII	IP65 IP44 Plug	74kg	INC.	25mm

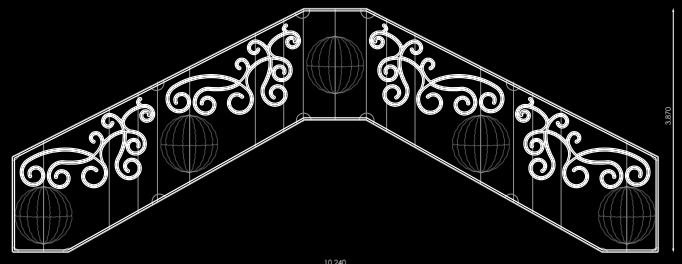

## Información/Information/Information/Informações

**N/** Este producto se suministra sin los postes para su sujeción, que debe poner el cliente.

**E/** This product is supplied without the posts to hold it, which must be installed by the customer.

**F/** Ce produit est fourni sans les poteaux pour le maintenir, qui doivent être installés par le client.

**P/** Este produto é fornecido sem as colunas para sustentá-lo, que devem ser instaladas pelo cliente.



# Portada Cingula



Motivo  
Motifs  
Motifs  
Motivos



[GRÁFICOS: Unidades en mm/ GRÁFICOS: Units in mm/ GRAPHIQUES: Unités en mm/ GRÁFICOS: Unidades em mm]

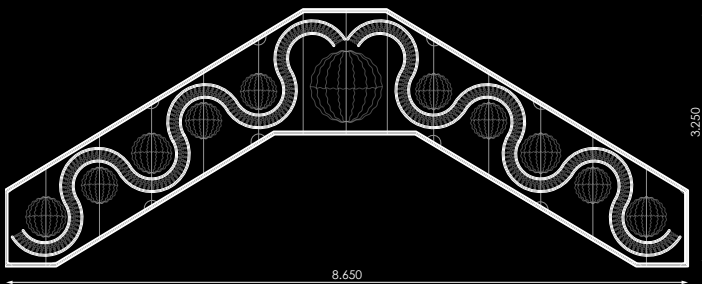

509886	flexi	STRING PLUS	SPHERE 3D ø90cm CW SPHERE 3D ø50cm WW SPHERE Mini 2D VERDE			
W						
354	230V	CII	IP65 IP44 Plug	70kg	INC.	25mm



## Información/Information/Information/Informações

**N**/ Este producto se suministra sin los postes para su sujeción, que debe poner el cliente.

**E**/ This product is supplied without the posts to hold it, which must be installed by the customer.

**F**/ Ce produit est fourni sans les poteaux pour le maintenir, qui doivent être installés par le client.

**P**/ Este produto é fornecido sem as colunas para sustentá-lo, que devem ser instaladas pelo cliente.

# Shooting Star

## Pattern



**N** Nuevo  
New  
Nouveau  
Novo

Motivo  
Motifs  
Motifs  
Motivos



LATERAL  
IZQUIERDO



CENTRAL  
IZQUIERDO



CENTRAL  
DERECHO



LATERAL  
DERECHO



### CENTRAL

529983	560191	flexi	STRING
W			
70,67W	230V	CII	IP65 IP44 Plug
		8,5kg	203x183x7,5cm
			INC. 10x10mm

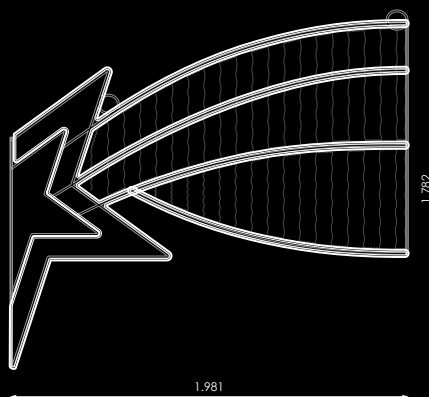

### LATERAL

529952	529969	flexi	STRING
W			
141,33W	230V	CII	IP65 IP44 Plug
		14kg	310x189x7,5cm
			INC. 10x10mm

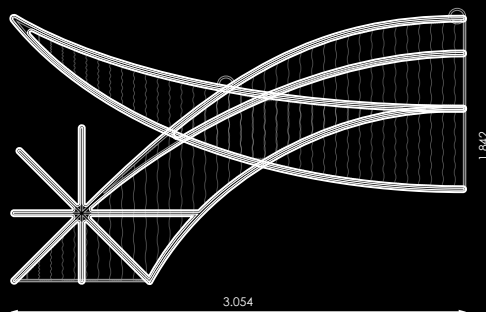



10m

Shooting Star Pattern LATERAL izquierda (529952) + Shooting Star Pattern CENTRAL izquierda (529983) + Shooting Star Pattern CENTRAL derecha (560191) + Shooting Star Pattern LATERAL derecha (529969)

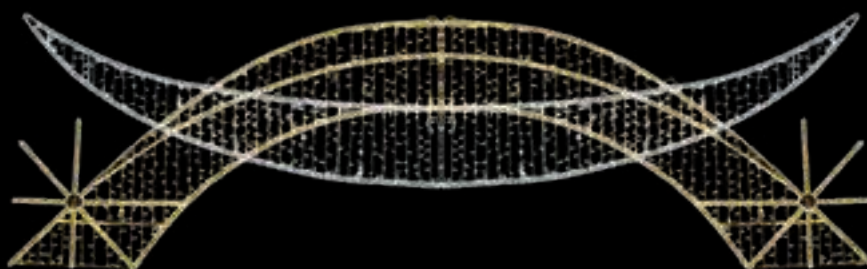

6m

Shooting Star Pattern LATERAL izquierda (529952) + Shooting Star Pattern LATERAL derecha (529969)



4m

Shooting Star Pattern CENTRAL izquierda (529983) + Shooting Star Pattern CENTRAL derecha (560191)

OPCIÓN DE COMPOSICIÓN / COMPOSITION OPTION  
 OPTION DE COMPOSITION / OPÇÃO DE COMPOSIÇÃO

# Ice Waves

## Pattern



**N** Nuevo  
New  
Nouveau  
Novo

Motivo  
Motifs  
Motifs  
Motivos



CENTRAL



LATERAL



### CENTRAL



560306



flexi LED LED



STRING PLUS LED LED



91W 230V CII IP65 IP44 Plug 6,5kg 147x173x7,5cm INC. 20x10mm



### LATERAL



560290



flexi LED LED



STRING PLUS LED LED



87W 230V CII IP65 IP44 Plug 10,5kg 205x173x7,5cm INC. 20x10mm

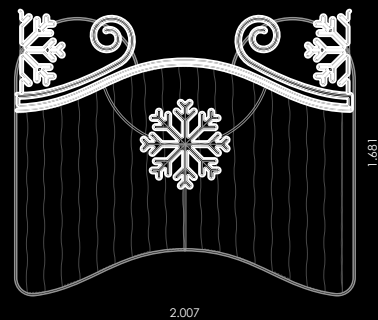



5,4m

Ice Waves Pattern LATERAL + Ice Waves Pattern CENTRAL + Ice Waves Pattern LATERAL



8m

Ice Waves Pattern LATERAL + Ice Waves Pattern LATERAL + Ice Waves Pattern LATERAL + Ice Waves Pattern LATERAL



4,25m

Ice Waves Pattern CENTRAL + Ice Waves Pattern CENTRAL + Ice Waves Pattern CENTRAL

# Screen PIXELMAX



**N** Nuevo  
New  
Nouveau  
Novo

Motivo  
Motifs  
Motifs  
Motivos

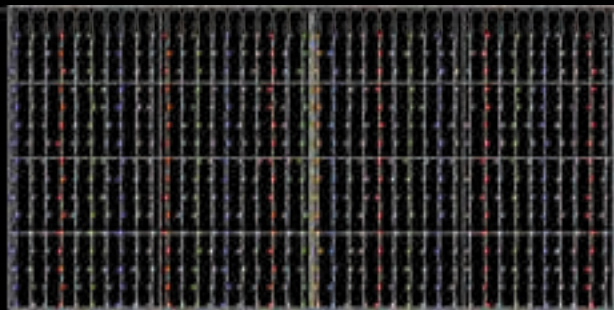

562126

SCREEN PIXELMAX



528W 66V ac CII IP44 65kg 205x205x15cm INC. 16x16mm

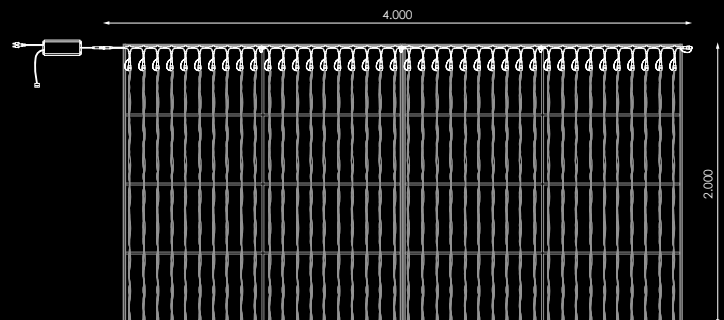

## Información/Information/Information/Informações



**Ñ**/ Controlador Master y Slave servidos en caja estanca IP66.

**E**/ Master and Slave controller served in IP66 watertight box.

**F**/ Contrôleur maître et esclave servi dans une boîte étanche IP66.

**P**/ Controladores Master e Slave servidos em caixa estanca IP66.



# Silhouette Star



Nuevo  
New  
Nouveau  
Novo

N



Motivo  
Motifs  
Motifs  
Motivos



Silhouette Star + Fly + Silhouette Star

OPCIÓN DE COMPOSICIÓN/ COMPOSITION OPTION  
OPTION DE COMPOSITION/ OPÇÃO DE COMPOSIÇÃO

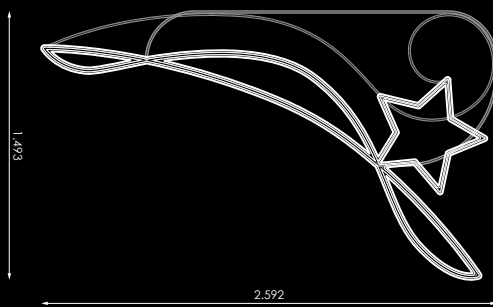

		<b>1</b>	<b>2</b>				
529020	flexi LED	flexi LED	STRING PLUS LED				
W							
51W	230V	CII	IP65 IP44 Plug	6kg	154x264x5cm	INC.	20x10mm



# Star Duo

Nuevo  
New  
Nouveau  
Novo

N



Motivo  
Motifs  
Motifs  
Motivos



Star Duo + Star Duo

OPCIÓN DE COMPOSICIÓN/ COMPOSITION OPTION  
OPTION DE COMPOSITION/ OPÇÃO DE COMPOSIÇÃO

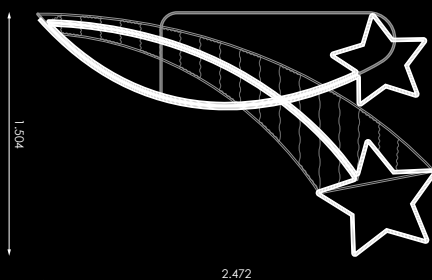

529099	flexi LED	flexi LED	STRING PLUS LED				
W							
45,6W	230V	CII	IP65 IP44 Plug	6kg	155x252x5cm	INC.	20x10mm

# Eclectic Ulva



Motivo  
Motifs  
Motifs  
Motivos



Eclectic Ulva + Tulip + Eclectic Ulva

OPCIÓN DE COMPOSICIÓN / COMPOSITION OPTION  
OPTION DE COMPOSITION / OPÇÃO DE COMPOSIÇÃO

		□	■	W
509961	A	flexi LED	STRING PLUS LED	41W
509978	B	flexi LED	STRING PLUS LED	35W
509985	C	flexi LED	STRING PLUS LED	35W

⚡	□	⚙️	⚖️	📦	🔌	📏
230V	CII	IP65 IP44 Plug	6,5kg	191x108x5cm	INC.	10mm

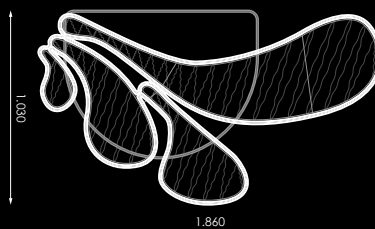

# Eclectic Fan



Motivo  
Motifs  
Motifs  
Motivos

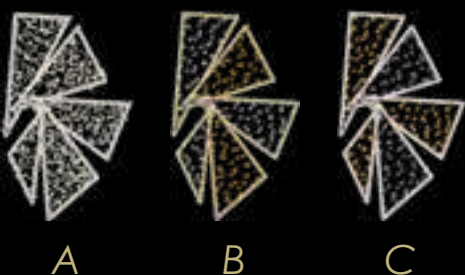

Eclectic Fan + Kabalah + Eclectic Fan

OPCIÓN DE COMPOSICIÓN / COMPOSITION OPTION  
OPTION DE COMPOSITION / OPÇÃO DE COMPOSIÇÃO

		□	1	2	W
510066	A	flexi LED	STRING PLUS LED	-	90W
510073	B	flexi LED	STRING PLUS LED	STRING PLUS LED	80W
510080	C	flexi LED	STRING PLUS LED	STRING PLUS LED	80W

⚡	□	⚙️	⚖️	📦	🔌	📏
230V	CII	IP65 IP44 Plug	9kg	188x115x5cm	INC.	10mm



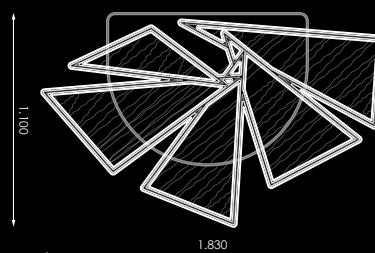

# Eclectic Nari



Motivo  
Motifs  
Motifs  
Motivos



Ávila



Eclectic Nari

+

Tear

+

Eclectic Nari



A

B

C



OPCIÓN DE COMPOSICIÓN/ COMPOSITION OPTION  
OPTION DE COMPOSITION/ OPÇÃO DE COMPOSIÇÃO

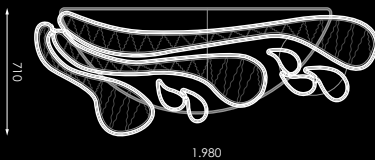

		□	■	W	
509916	A	flexi LED LED	STRING PLUS LED	50W	
509923	B	flexi LED LED	STRING PLUS LED LED	43W	
509930	C	flexi LED LED	STRING PLUS LED LED	43W	
⚡	□	⦿	⚖	⊞	⊞
230V	CII	IP65 IP44 Plug	7kg	203x76x5cm	INC. 10mm

[GRÁFICOS: Unidades en mm/ GRÁFICOS: Units in mm/ GRÁFICOS: Unidades en mm/ GRÁFICOS: Unidades en mm]

# Eclectic Slope



Motivo  
Motifs  
Motifs  
Motivos



A B C



Fly + Eclectic Slope + Fly

OPCIÓN DE COMPOSICIÓN / COMPOSITION OPTION  
OPTION DE COMPOSITION / OPÇÃO DE COMPOSIÇÃO

		□	■	W
510011	A	flexi LED	STRING PLUS LED	60W
510028	B	flexi LED	STRING PLUS LED	55W
510035	C	flexi LED	STRING PLUS LED	55W

⚡	□	⊙	⚖	🏠	🔌	📏
230V	CII	IP65 IP44 Plug	6kg	194x80x5cm	INC.	10mm

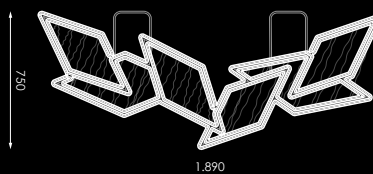

# Eclectic Hive



Motivo  
Motifs  
Motifs  
Motivos

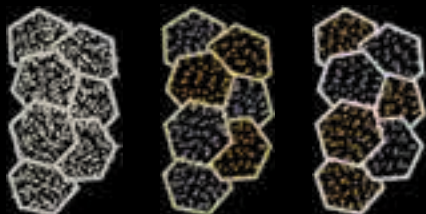

A B C

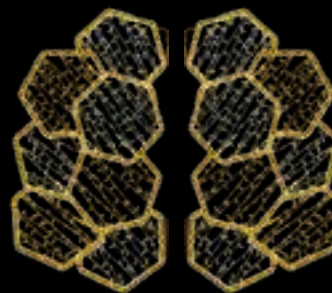

Eclectic Hive + Eclectic Hive

OPCIÓN DE COMPOSICIÓN / COMPOSITION OPTION  
OPTION DE COMPOSITION / OPÇÃO DE COMPOSIÇÃO

		□	1	2	W
510110	A	flexi LED	STRING PLUS LED	-	83W
510127	B	flexi LED	STRING PLUS LED	STRING PLUS LED	74W
510134	C	flexi LED	STRING PLUS LED	STRING PLUS LED	74W

⚡	□	⊙	⚖	🏠	🔌	📏
230V	CII	IP65 IP44 Plug	8kg	188x102x5cm	INC.	10mm



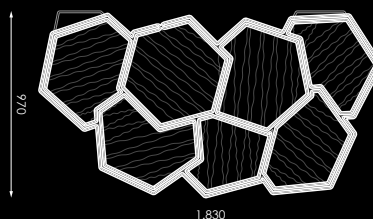

# Infinity



Motivo  
Motifs  
Motifs  
Motivos



Ávila



Nadir

+

Nadir

OPCIÓN DE COMPOSICIÓN / COMPOSITION OPTION  
OPCIÓN DE COMPOSICIÓN / OPÇÃO DE COMPOSIÇÃO

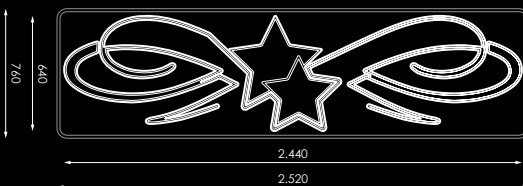

Barcode	Option	flexi LED LED
416092	A	flexi LED LED
416108	B	flexi LED LED
416115	C	flexi LED LED
416122	D	flexi LED LED
416139	E	flexi LED LED

W	⚡	□	⦿	kg	📦	🔌	📏
45W	230V	CII	IP65 IP44 Plug	6kg	260x78x5cm	INC.	10mm

# Nadir



Motivo  
Motifs  
Motifs  
Motivos



Nadir

+

Nadir

OPCIÓN DE COMPOSICIÓN/ COMPOSITION OPTION  
OPTION DE COMPOSITION/ OPÇÃO DE COMPOSIÇÃO

	▮▮▮▮	□	■
385954	A	flexi LED LED	STRING PLUS LED
385961	B	flexi LED LED	STRING PLUS LED
W	⚡	□	⊕
64W	230V	CII	IP65 IP44 Plug
		11kg	128x263x5cm
			INC. 25mm

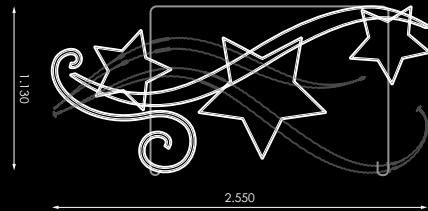

# Wimbi String



Motivo  
Motifs  
Motifs  
Motivos



Wimbi String

+

Arkaid

+

Wimbi String

OPCIÓN DE COMPOSICIÓN/ COMPOSITION OPTION  
OPTION DE COMPOSITION/ OPÇÃO DE COMPOSIÇÃO

	▮▮▮▮	1	2
488747	A	flexi LED	STRING PLUS LED
415453	B	flexi LED	STRING PLUS LED LED
415460	C	flexi LED	STRING PLUS LED LED
415477	D	flexi LED	STRING PLUS LED LED
415484	E	flexi LED	STRING PLUS LED LED
W	⚡	□	⊕
23W	230V	CII	IP65 IP44 Plug
		4kg	73x205x5cm
			INC. 10mm

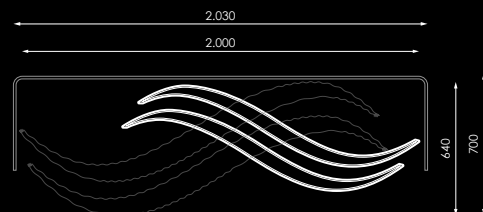



# Wimbi



Motivo  
Motifs  
Motifs  
Motivos



Ávila



Wimbi

+

Wimbi

OPCIÓN DE COMPOSICIÓN/ COMPOSITION OPTION  
OPTION DE COMPOSITION/ OPÇÃO DE COMPOSIÇÃO

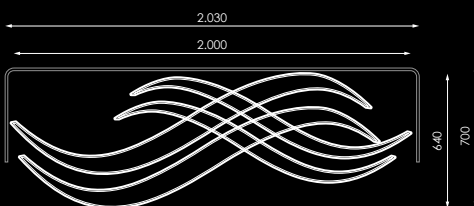

	Barcode	Option	flexi LED LED
488730		A	flexi LED LED
412902		B	flexi LED LED
415408		C	flexi LED LED
415415		D	flexi LED LED
415422		E	flexi LED LED

W	⚡	□	⚙️	⚖️	📏	🔌	📏
40W	230V	CII	IP65 IP44 Plug	4kg	73x205x5cm	INC.	10mm

[GRÁFICOS: Unidades en mm/ GRÁFICOS: Units in mm/ GRÁFICOS: Unidades en mm/ GRÁFICOS: Unidades en mm]

**N** Nuevo  
New  
Nouveau  
Novo

Motivo  
Motifs  
Motifs  
Motivos



A



B



C



D



Barcode	Model	Theme	Light Type
529662	A	ARPA	flexi DOUBLE NEON LED LED
529679	B	TROMPETA	flexi DOUBLE NEON LED LED
529686	C	CANDELA	flexi DOUBLE NEON LED LED
529693	D	CAMPANA	flexi DOUBLE NEON LED LED

W	⚡	□	⦿	⚖	📦	🔌	📏
99W	230V	CII	IP65 IP44 Plug	5kg	140x192x5cm	INC.	10mm

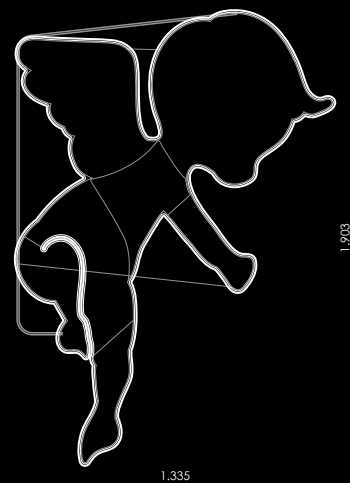





# Angel Vela



Motivo  
Motifs  
Motifs  
Motivos



A

B

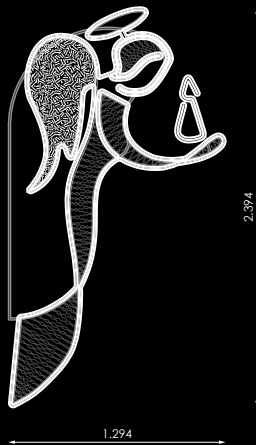

			1	2			
210003	A	flexi LED LED	STRING PLUS LED LED	TAPIZ			
387408	B	flexi LED LED	STRING PLUS LED LED	TAPIZ			
<b>W</b>	<b>⚡</b>	<b>□</b>	<b>⊙</b>	<b>⚖</b>	<b>⊞</b>	<b>⚗</b>	<b>⊞</b>
62,5W	230V	CII	IP65 IP44 Plug	7,5kg	150x263x5cm	INC.	25mm



# Céfiro



Motivo  
Motifs  
Motifs  
Motivos



Céfiro

+

Star Mini

+

Céfiro

OPCIÓN DE COMPOSICIÓN/ COMPOSITION OPTION  
OPTION DE COMPOSITION/ OPÇÃO DE COMPOSIÇÃO



A

B

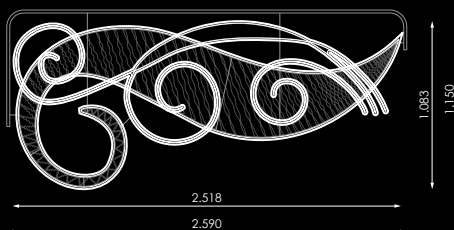

386159	A	flexi LED LED	STRING PLUS LED				
385893	B	flexi LED LED	STRING PLUS LED				
<b>W</b>	<b>⚡</b>	<b>□</b>	<b>⊙</b>	<b>⚖</b>	<b>⊞</b>	<b>⚗</b>	<b>⊞</b>
102W	230V	CII	IP65 IP44 Plug	11kg	116x268x5cm	INC.	20x10mm

# Acanto



Motivo  
Motifs  
Motifs  
Motivos



Acanto + Star mini + Acanto

OPCIÓN DE COMPOSICIÓN/ COMPOSITION OPTION  
OPTION DE COMPOSITION/ OPÇÃO DE COMPOSIÇÃO

	☰	□	■
385992	A	flexi LED LED	STRING PLUS LED
386005	B	flexi LED LED	STRING PLUS LED
386012	C	flexi LED LED	STRING PLUS LED
<b>W</b>	<b>⚡</b>	<b>□</b>	<b>⦿</b>
55W	230V	CII	IP65 IP44 Plug
		<b>⚖</b>	<b>⊞</b>
		9kg	118x268x5cm
			INC. 10mm

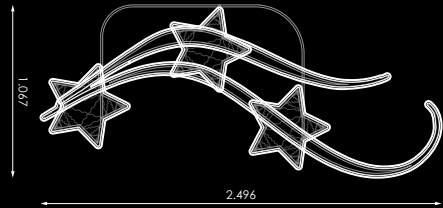

# Spiral Loop



Motivo  
Motifs  
Motifs  
Motivos

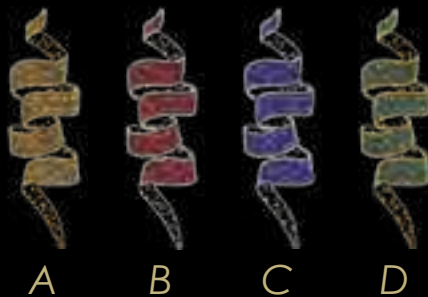

Spiral Loop + Spiral Loop

OPCIÓN DE COMPOSICIÓN/ COMPOSITION OPTION  
OPTION DE COMPOSITION/ OPÇÃO DE COMPOSIÇÃO

	☰	□	1	2
209267	A	flexi LED	STRING PLUS LED	TAPIZ
209274	B	flexi LED	STRING PLUS LED LED	TAPIZ
209281	C	flexi LED	STRING PLUS LED LED	TAPIZ
209298	D	flexi LED	STRING PLUS LED LED	TAPIZ
<b>W</b>	<b>⚡</b>	<b>□</b>	<b>⦿</b>	<b>⊞</b>
36W	230V	CII	IP65 IP44 Plug	7.5kg
				80x263x5cm
				INC. 25mm

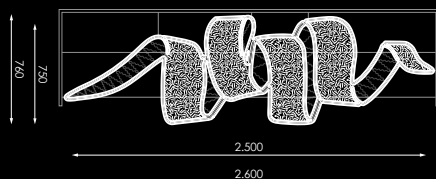



# Flower Star



Motivo  
Motifs  
Motifs  
Motivos



Ávila



Flower Star + Star mini Double + Flower Star

OPCIÓN DE COMPOSICIÓN / COMPOSITION OPTION  
OPTION DE COMPOSITION / OPÇÃO DE COMPOSIÇÃO



A

B

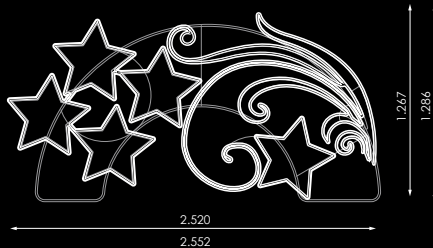

	209403	A flexi
	209434	B flexi
<b>W</b>		
78W	230V	CII
	IP65	11kg
	IP44 Plug	138x258x5cm
	INC.	25mm

[GRÁFICOS: Unidades en mm/ GRÁFICOS: Units in mm/ GRÁFICOS: Unidades en mm/ GRÁFICOS: Unidades en mm]



Ávila



# Flambeau



Motivo  
Motifs  
Motifs

Flambeau + Tears + Flambeau

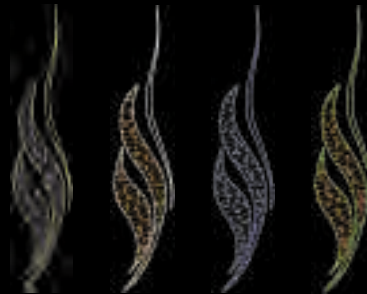

A B C D



OPCIÓN DE COMPOSICIÓN / COMPOSITION OPTION  
OPTION DE COMPOSITION / OPÇÃO DE COMPOSIÇÃO

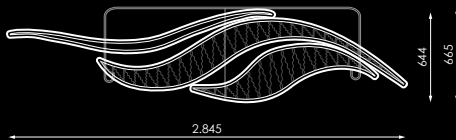

		□	■
209717	A	flexi LED	STRING PLUS LED
209724	B	flexi LED	STRING PLUS LED
209731	C	flexi LED	STRING PLUS LED
209748	D	flexi LED	STRING PLUS LED

W	⚡	□	⦿	⚖	⊠	⌚	□
42W	230V	CII	IP65 IP44 Plug	6,5kg	67x305x5cm	INC.	25mm



# Spiral Star

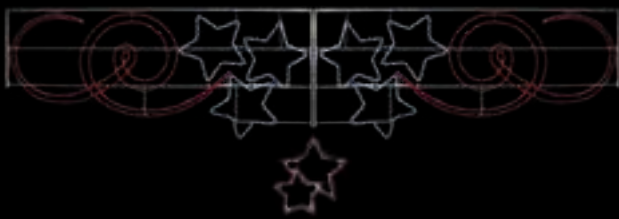

Motivo  
Motifs  
Motifs

Spiral Star + Double star + Spiral Star



A B C



OPCIÓN DE COMPOSICIÓN / COMPOSITION OPTION  
OPTION DE COMPOSITION / OPÇÃO DE COMPOSIÇÃO

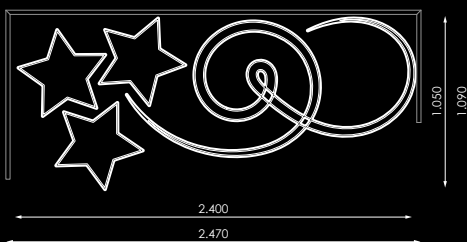

		□	■
209311	A	flexi LED	LED
209335	B	flexi LED	LED
209328	C	flexi LED	LED

W	⚡	□	⦿	⚖	⊠	⌚	□
47W	230V	CII	IP65 IP44 Plug	7kg	111x250x5cm	INC.	25mm

Motivo  
Motifs  
Motifs  
Mofivos



Ávila



Agard + Arkaid + Agard

OPCIÓN DE COMPOSICIÓN / COMPOSITION OPTION  
OPCIÓN DE COMPOSICIÓN / OPÇÃO DE COMPOSIÇÃO



209823	A	flexi	STRING
209847	B	flexi	STRING
209878	C	flexi	STRING

45W	230V	CII	IP65 IP44 Plug	8kg	80x312x5cm	INC.	25mm



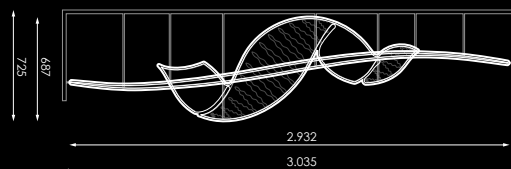

# Arabesque



Motivo  
Motifs  
Motifs  
Motivos

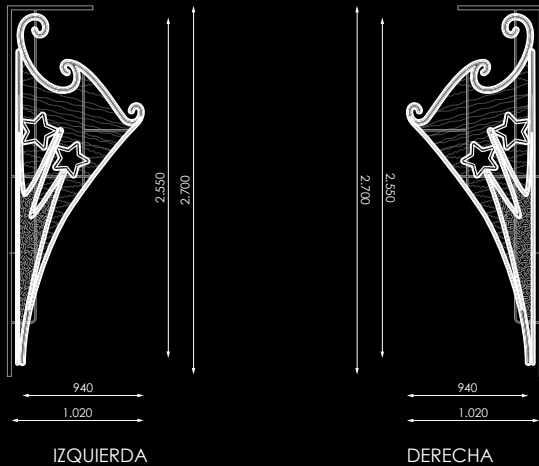

			<b>1</b>	<b>2</b>			
148986	414166	flexi	STRING <b>PLUS</b>	TAPIZ			
<b>W</b>							
51W	230V	CII	IP65 IP44 Plug	7kg	105x273x5cm	INC.	25mm



# Estrellas



Motivo  
Motifs  
Motifs  
Motivos



Estrellas

+

Estrellas

OPCIÓN DE COMPOSICIÓN/ COMPOSITION OPTION  
OPTION DE COMPOSITION/ OPÇÃO DE COMPOSIÇÃO

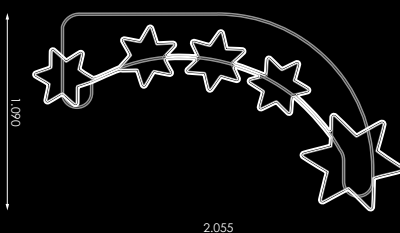
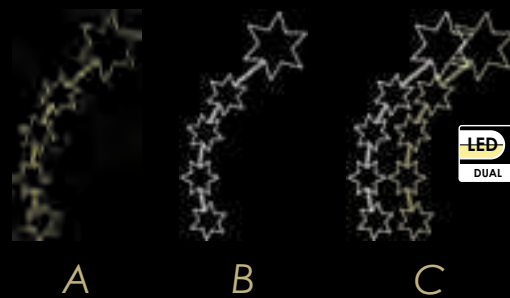

		<b>W</b>				
385244	A flexi	21W				
972062	B flexi	21W				
385251	C flexi	25W				
230V	CII	IP65 IP44 Plug	8kg	121x210x5cm	INC.	25mm

# Melchor



**N** Nuevo  
New  
Nouveau  
Novo

Motivo  
Motifs  
Motifs  
Motivos



567190	flexi	STRING PLUS
119W	230V	CII
IP65	IP44 Plug	8kg
110x225x5cm	INC.	10x20mm

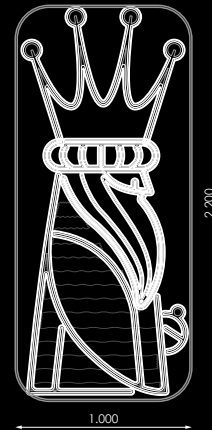

# Gaspar



**N** Nuevo  
New  
Nouveau  
Novo

Motivo  
Motifs  
Motifs  
Motivos



567206	flexi	STRING PLUS
135W	230V	CII
IP65	IP44 Plug	8kg
110x225x5cm	INC.	10x20mm

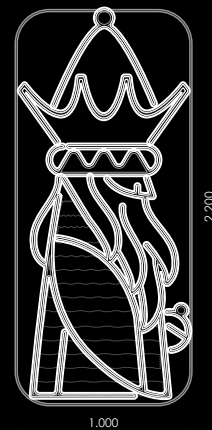





# AS CANCELAS







# Baltasar

Nuevo  
New  
Nouveau  
Novo **N**

Motivo  
Motifs  
Motifs  
Motivos

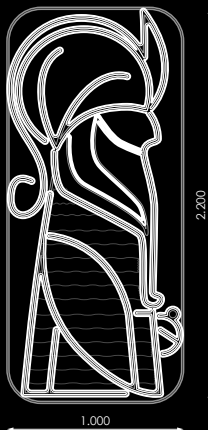

567213		flexi <b>LED</b> <b>LED</b> <b>LED</b> <b>LED</b>				STRING <b>PLUS</b> <b>LED</b>	
W	⚡	□	⊕	⚖	⊞	⌚	□
125W	230V	CII	IP65 IP44 Plug	8kg	110x225x5cm	INC.	10x20mm



# Camello

Nuevo  
New  
Nouveau  
Novo **N**

Motivo  
Motifs  
Motifs  
Motivos

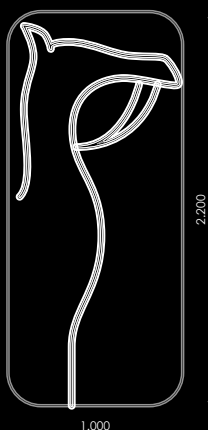

567220		flexi <b>LED</b> <b>LED</b>					
W	⚡	□	⊕	⚖	⊞	⌚	□
39W	230V	CII	IP65 IP44 Plug	5kg	110x225x5cm	INC.	10x20mm

# Bolma

## LILIUM



**N** Nuevo  
New  
Nouveau  
Novo

Motivo  
Motifs  
Motifs  
Motivos



567237	flexi	STRING PLUS					
106W	230V	CII	IP65 IP44 Plug	8kg	190x1905x7,5cm	INC.	10x20mm

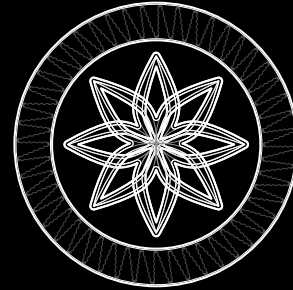

Ø 11.800

# Bolma

## ARKAID



**N** Nuevo  
New  
Nouveau  
Novo

Motivo  
Motifs  
Motifs  
Motivos



567244	flexi	STRING PLUS					
96W	230V	CII	IP65 IP44 Plug	8kg	190x1905x7,5cm	INC.	10x20mm

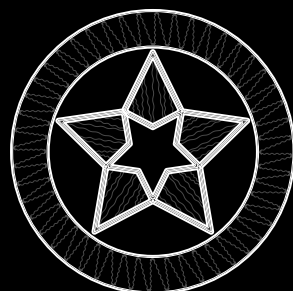

Ø 11.800



# Bolma

## STAR FLAKE

Nuevo  
New  
Nouveau  
Novo **N**



Motivo  
Motifs  
Motifs  
Motivos

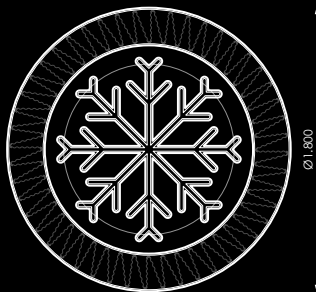

567251	flexi LED	STRING PLUS LED					
<b>W</b>							
103W	230V	CII	IP65 IP44 Plug	8kg	190x1905x7,5cm	INC.	10x20mm



# Bulán

Nuevo  
New  
Nouveau  
Novo **N**



Motivo  
Motifs  
Motifs  
Motivos

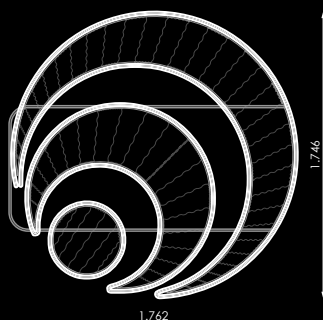

529082	flexi LED	STRING PLUS LED					
<b>W</b>							
58,6W	230V	CII	IP65 IP44 Plug	7,3kg	190x190x7,5cm	INC.	10x20mm

# Bulán



**N** Nuevo  
New  
Nouveau  
Novo

Motivo  
Motifs  
Motifs  
Motivos



A B C

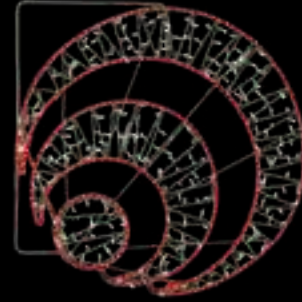

	414982	A	flexi LED STRING PLUS LED
	<b>N</b> 567343	B	flexi LED STRING PLUS LED
	<b>N</b> 567350	C	flexi LED STRING PLUS LED
<b>W</b>			
36W	230V	CII	IP65 IP44 Plug
		6kg	115x115x5cm
		INC.	10mm

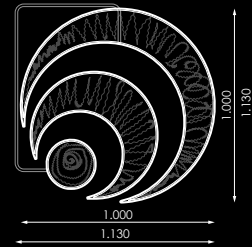

# Stea



Motivo  
Motifs  
Motifs  
Motivos



A B C



	441629	A	flexi LED flexi LED
	441636	B	flexi LED flexi LED
	441643	C	flexi LED flexi LED
<b>W</b>			
78W	230V	CII	IP65 IP44 Plug
		8kg	135x160x5cm
		INC.	10mm

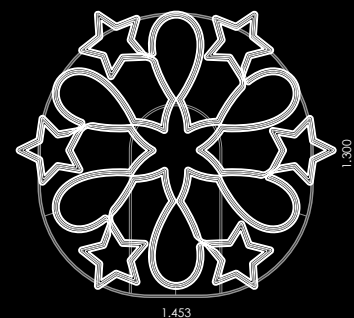



San Sebastian de los Reyes - Madrid

# Lilium

## PUNTA CONO



# Lilium



**N** Nuevo  
New  
Nouveau  
Novo

**Motivo**  
Motifs  
Motifs  
Motivos



516327	flexi	Ø78cm				
<b>W</b>						
36W	230V	CII	IP65 IP44 Plug	4,3kg	83x83x5cm	INC.

510141	flexi	Ø78cm				
<b>W</b>						
36W	230V	CII	IP65 IP44 Plug	4kg	83x83x5cm	INC.

516341	flexi	Ø117cm				
<b>W</b>						
54W	230V	CII	IP65 IP44 Plug	6,3kg	122x122x5cm	INC.

510165	flexi	Ø117cm				
<b>W</b>						
54W	230V	CII	IP65 IP44 Plug	6kg	122x122x5cm	INC.

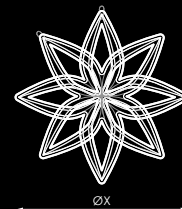
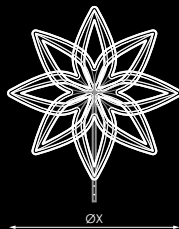





# Kabalah



# Happa



Motivo  
Motifs  
Motifs  
Motivos



Motivo  
Motifs  
Motifs  
Motivos



510189	flexi LED	Ø76,5cm
510196	flexi LED	Ø76,5cm

W						
27W	230V	CII	IP65 IP44 Plug	3kg	82x82x5cm	INC.

510219	flexi LED	Ø118cm
510226	flexi LED	Ø118cm

W						
42W	230V	CII	IP65 IP44 Plug	4kg	123x123x5cm	INC.

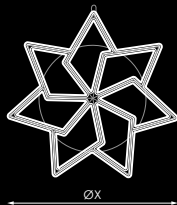

510301	flexi LED	Ø85cm
510318	flexi LED	Ø85cm

W						
15W	230V	CII	IP65 IP44 Plug	2,5kg	90x90x5cm	INC.

510332	flexi LED	Ø121cm
510349	flexi LED	Ø121cm

W						
21W	230V	CII	IP65 IP44 Plug	3kg	126x126x5cm	INC.

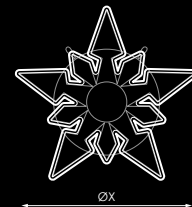

[GRÁFICOS: Unidades en mm/ GRÁFICOS: Units in mm/ GRÁFICOS: Unités en mm/ GRÁFICOS: Unidades em mm]

# Reno Double Neon

180cm

# Reno Double Neon

140cm

Motivo  
Motifs  
Motifs  
Motivos



Motivo  
Motifs  
Motifs  
Motivos



487511



flexi DOUBLE NEON



487528



flexi DOUBLE NEON

W



117W

230V

CII

IP54  
IP44 Plug

186x116x5cm

INC.

W



90W

230V

CII

IP54  
IP44 Plug

146x90x5cm

INC.

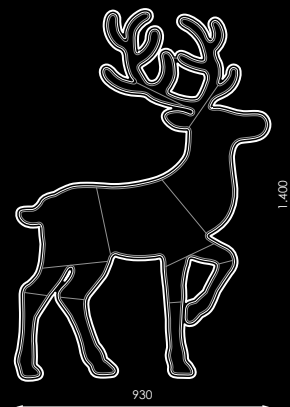
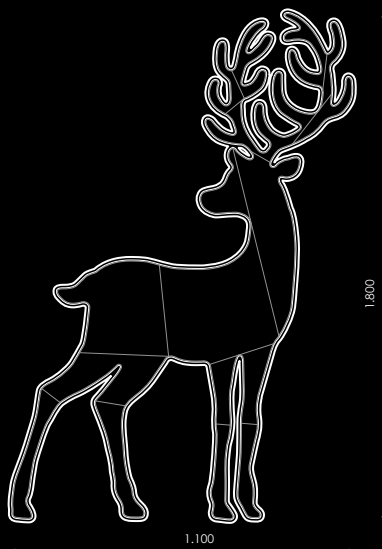



# Arkaid



# Gift Box Loop II



Motivo  
Motifs  
Motifs  
Motivos



Motivo  
Motifs  
Motifs  
Motivos



A



B



C



		1	2	
415101	A	flexi LED	flexi LED	STRING PLUS LED
488778	B	flexi LED	flexi LED	STRING PLUS LED
W	⚡	□	⊙	⊙
44W	230V	CII	IP65 IP44 Plug	5kg
				120x120x5cm
				INC.

			1	2
442930	A	flexi LED LED	STRING PLUS LED	TAPIZ
442947	B	flexi LED LED	STRING PLUS LED	TAPIZ
442954	C	flexi LED LED	STRING PLUS LED	TAPIZ
W	⚡	□	⊙	⊙
97W	230V	CII	IP65 IP44 Plug	9kg
				153x190x5cm
				INC.
				10mm

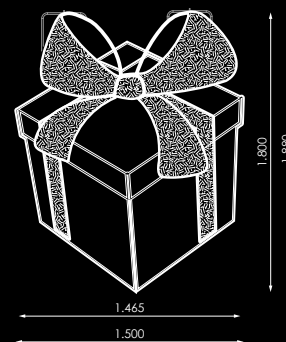
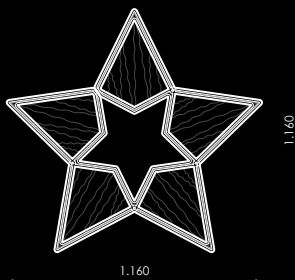

# Gift I



# Star Flake



Motivo  
Motifs  
Motifs  
Motivos



Motivo  
Motifs  
Motifs  
Motivos

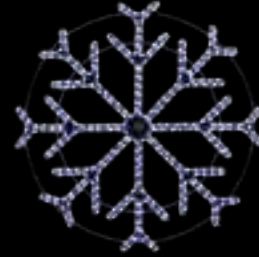

Barcode	Model	Material	Size
194037	A	flexi LED	Ø80cm
194013	B	flexi LED	Ø80cm
194044	C	flexi LED	Ø80cm

W	⚡	□	⊙	⚖	⊞	⚡
33W	230V	CII	IP65 IP44 Plug	2,5kg	83x83x5cm	INC.

Barcode	Model	Material	STRING	PLUS	LED	TAPIZ
375726	A	flexi LED LED	STRING PLUS LED LED	TAPIZ	1	2
375696	B	flexi LED LED	STRING PLUS LED LED	TAPIZ	1	2
375733	C	flexi LED LED	STRING PLUS LED LED	TAPIZ	1	2

W	⚡	□	⊙	⚖	⊞	⚡	□
63W	230V	CII	IP65 IP44 Plug	8,5kg	120x120x5cm	INC.	10mm

Barcode	Model	Material	Size
194068	A	flexi LED	Ø120cm
194051	B	flexi LED	Ø120cm
194075	C	flexi LED	Ø120cm

W	⚡	□	⊙	⚖	⊞	⚡
51W	230V	CII	IP65 IP44 Plug	4,5kg	123x123x5cm	INC.

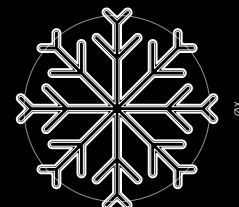
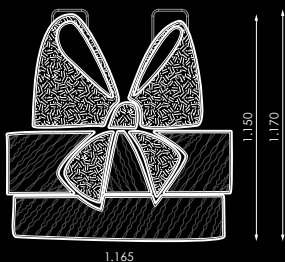



# Cometa II



Motivo  
Motifs  
Motifs  
Motivos



A



B



C



Barcode	Model	Material	Power (W)
489560	A	flexi DOUBLE NEON LED	63W
488815	B	flexi DOUBLE NEON LED	63W
488785	C	flexi LED	32,2W

⚡	□	⚙️	⚖️	📦	🔌	📏
230V	CII	IP65 IP44 Plug	2kg	110x50x5cm	INC.	25mm

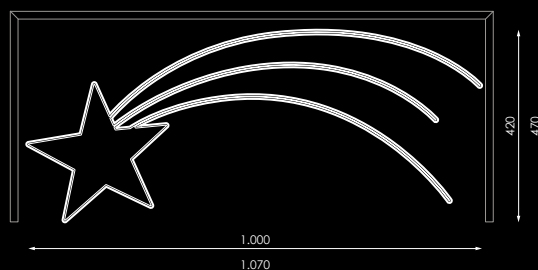

Barcode	Model	Material	Power (W)
489577	A	flexi DOUBLE NEON LED	90W
488822	B	flexi DOUBLE NEON LED	90W
488792	C	flexi LED	46W

⚡	□	⚙️	⚖️	📦	🔌	📏
230V	CII	IP65 IP44 Plug	3,5kg	159x71x5cm	INC.	25mm

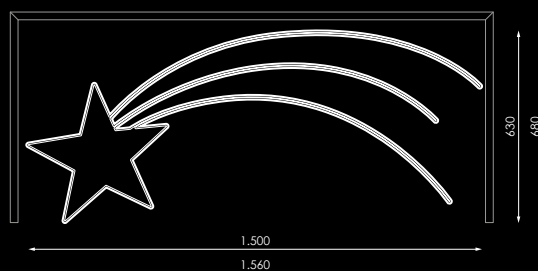

Barcode	Model	Material	Power (W)
489584	A	flexi DOUBLE NEON LED	189W
488839	B	flexi DOUBLE NEON LED	189W
488808	C	flexi LED	96,6W

⚡	□	⚙️	⚖️	📦	🔌	📏
230V	CII	IP65 IP44 Plug	9kg	311x133x5cm	INC.	25mm



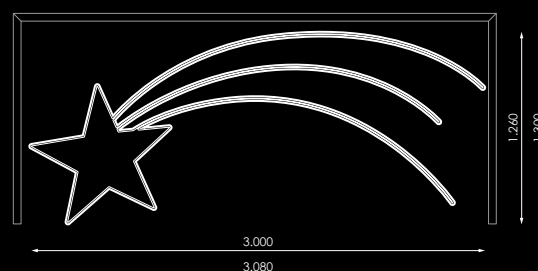

# Reyes Magos CON ESTRELLA FUGAZ

Nuevo  
New  
Nouveau  
Novo

N



Motivo  
Motifs  
Motifs  
Motivos

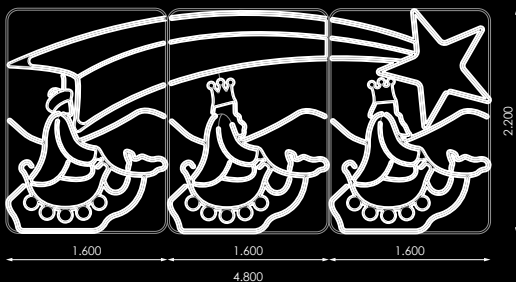

567367		flexi LED LED					
W	⚡	□	⦿	⚖	📦	🔌	📏
270W	230V	CII	IP65 IP44 Plug	32kg	170x230x20cm	INC.	10x20mm

[GRÁFICOS: Unidades en mm/ GRÁFICOS: Units in mm/ GRÁFICOS: Unités en mm/ GRÁFICOS: Unidades em mm]







# Belén 2D

Nuevo  
New  
Nouveau  
Novo **N**



Motivo  
Motifs  
Motifs  
Motivos



563635	flexi
<b>W</b>	
153W	230V
CII	IP44 Plug
15kg	280x200x7,5cm
INC.	10x20mm



# Belén 2D STRING

Nuevo  
New  
Nouveau  
Novo **N**



Motivo  
Motifs  
Motifs  
Motivos



564823	flexi	STRING PLUS
<b>W</b>		
164W	230V	CII
CII	IP44 Plug	17kg
17kg	280x200x7,5cm	INC.
10x20mm	10x20mm	10x20mm

# Wake



# Tulip



Motivo  
Motifs  
Motifs  
Motivos



Motivo  
Motifs  
Motifs  
Motivos

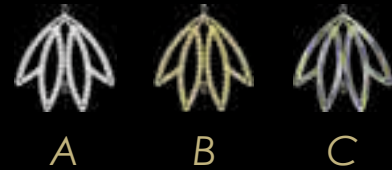

Barcode	Model	Power
510363	A flexi LED	15W
510370	B flexi LED	15W
510387	C flexi LED	23W

Barcode	Model	Power
510394	A flexi LED	18W
510400	B flexi LED	18W
510417	C flexi LED	28W

230V	CII	IP65 IP44 Plug	1,7kg	57x57x5cm	INC.

230V	CII	IP65 IP44 Plug	1,7kg	55x55x5cm	INC.

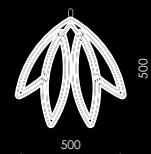
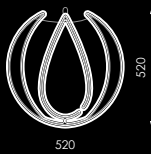



# Fly



# Tear



Motivo  
Mofifs  
Mofifs  
Motivos



Motivo  
Mofifs  
Mofifs  
Motivos

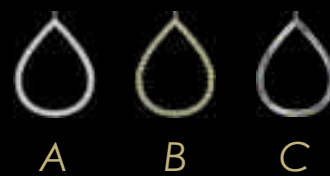

		1	2	W
510424	A	flexi	flexi	24W
510431	B	flexi	flexi	24W
510448	C	flexi	-	46W

			W
510455	A	flexi	9W
510462	B	flexi	9W
510479	C	flexi	14W

230V	CII	IP65 IP44 Plug	2,1kg	58x68x5cm	INC.

230V	CII	IP65 IP44 Plug	1kg	55x45x5cm	INC.

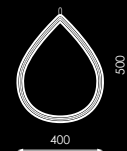
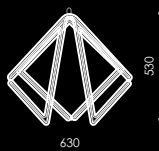

# Star Mini

## Double



# Star Mini

## Double Neon



Motivo  
Motifs  
Motifs  
Motivos



Motivo  
Motifs  
Motifs  
Motivos



Barcode	1	2	↕
412759	A flexi LED	flexi LED	Ø30cm
412766	B flexi LED	flexi LED	Ø30cm
412773	C flexi LED	flexi LED	Ø30cm

W	⚡	□	⦿	kg	📦	🔌
5,9W	230V	CII	IP65 IP44 Plug	1kg	35x35x5cm	INC.

Barcode	1	2	↕
412810	A flexi LED	flexi LED	Ø60cm
412827	B flexi LED	flexi LED	Ø60cm
412834	C flexi LED	flexi LED	Ø60cm

W	⚡	□	⦿	kg	📦	🔌
11,2W	230V	CII	IP65 IP44 Plug	1,5kg	65x65x5cm	INC.

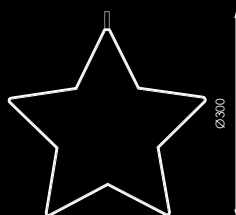

Barcode	1	2	↕
486217	A flexi DOUBLE NEON LED		
489195	B flexi DOUBLE NEON LED		
489201	C flexi DOUBLE NEON LED		
489188	D flexi DOUBLE NEON LED		

W	⚡	□	⦿	kg	📦	🔌
18W	230V	CII	IP65 IP44 Plug	1kg	53x53x5cm	INC.

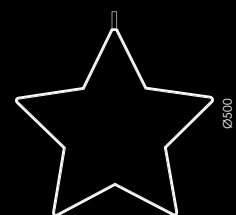



# Double Star Flashing



# Sphere Mini 2D



Motivo  
Motifs  
Motifs  
Motivos



Motivo  
Motifs  
Motifs  
Motivos

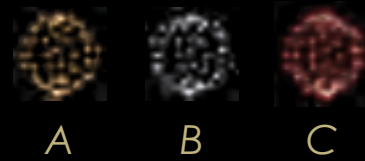

1		2	
412865	A	flexi LED	flexi LED
412872	B	flexi LED	flexi LED
412889	C	flexi LED	flexi LED
412896	D	flexi LED	flexi LED

W	⚡	□	⦿	⚖	📦	🔌
18W	230V	CII	IP65 IP44 Plug	1kg	35x35x5cm	INC.

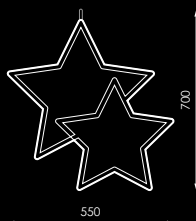

416078	A	STRING PLUS LED
416061	B	STRING PLUS LED
497374	C	STRING PLUS LED

W	⚡	□	⦿	⚖	📦	🔌
3W	230V	CII	IP65 IP44 Plug	1kg	50x50x5cm	INC.

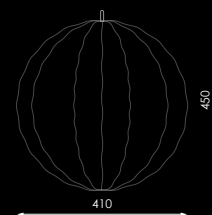

# Alpha

CON MOVIMIENTO

**N** Nuevo  
New  
Nouveau  
Novo

Motivo  
Motifs  
Motifs  
Motivos



566865	

<b>W</b>						
4W	230V	CII	IP44	1kg	43,5x43x4cm	INC.

566858	

<b>W</b>						
2,5W	230V	CII	IP44	0,7kg	28x28x4cm	INC.

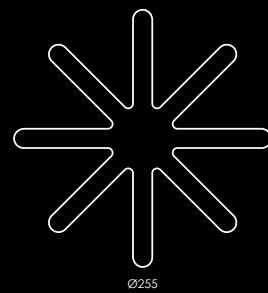
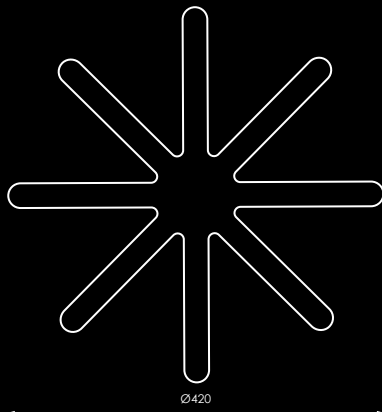

# Red Loop

# Gold Star PMMA

Nuevo  
New  
Nouveau  
Novo **N**

Nuevo  
New  
Nouveau  
Novo **N**



Motivo  
Motifs  
Motifs  
Motivos



Motivo  
Motifs  
Motifs  
Motivos



566452	flexi <b>LED</b>	STRING <b>PLUS</b> <b>LED</b>
<b>W</b>		
9W	230V	CII
IP44	2,3kg	55x50x5cm
		INC.

566445	flexi <b>LED</b> <b>LED</b>	PMMA
<b>W</b>		
13W	230V	CII
IP44	5kg	75x72x5cm
		INC.

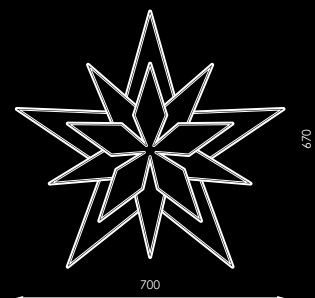
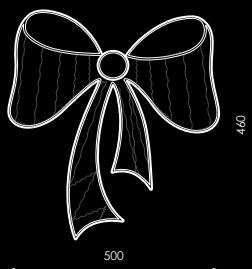

# Star 8 puntas pmma Star 8 puntas Doble

Motivo  
Motifs  
Motifs  
Motivos



Motivo  
Motifs  
Motifs  
Motivos

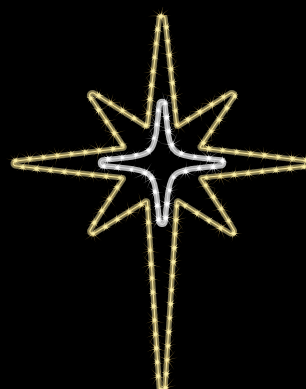

442626	flexi LED	PMMA				
442633	flexi LED	PMMA				
<b>W</b>						
12W	230V	CII	IP54	2kg	44x54x3,5cm	INC.

	<b>1</b>	<b>2</b>				
442664	flexi LED	flexi LED				
<b>W</b>						
11W	230V	CII	IP65 IP44 Plug	2kg	76x98x3,5cm	INC.

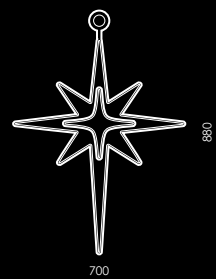
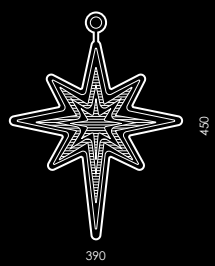





# Ball Mini



**Motivo**  
Motifs  
Motifs  
Motivos



194204	A flexi LED					
194211	B flexi LED					
194242	C flexi LED					
16W	230V	CII	IP65 IP44 Plug	1kg	53x53x5cm	INC.

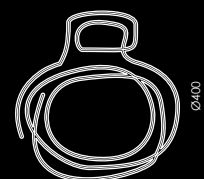

[GRÁFICOS: Unidades en mm/ GRÁFICOS: Units in mm/ GRÁFICOS: Unidades em mm]

# Mini Snow

Motivo  
Motifs  
Motifs  
Motivos



194457	A flexi
194426	B flexi
194433	C flexi
<b>W</b>	
15W	230V CII IP65 IP44 Plug
2kg	55x55x3cm INC.

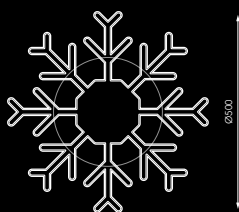

# Star Flake Mini

Motivo  
Motifs  
Motifs  
Motivos



195164	A flexi
195171	B flexi
195188	C flexi
<b>W</b>	
15W	230V CII IP65 IP44 Plug
2kg	55x55x3cm INC.

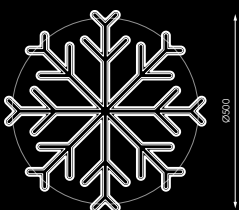

# Ring Ribbon



Motivo  
Motifs  
Motifs  
Mотивы



A



B



487535	A	flexi DOBLE NEON
487542	B	flexi DOBLE NEON
		Ø32cm

<b>W</b>						
9W	230V	CII	IP20	1kg	35x35x5cm	INC. 6m

487559	A	flexi DOBLE NEON
487566	B	flexi DOBLE NEON
		Ø64cm

<b>W</b>						
18W	230V	CII	IP20	2kg	67x67x5cm	INC. 6m

487573	A	flexi DOBLE NEON
487580	B	flexi DOBLE NEON
		Ø95,5cm

<b>W</b>						
27W	230V	CII	IP20	3kg	99x99x5cm	INC. 6m

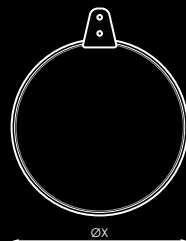

Bajo pedido/On request/Sur commande/A pedido



Cable alimentación IP44

L'Alcudia -  
Valencia

# Cone String



Motivo  
Motifs  
Motifs  
Motivos

3D

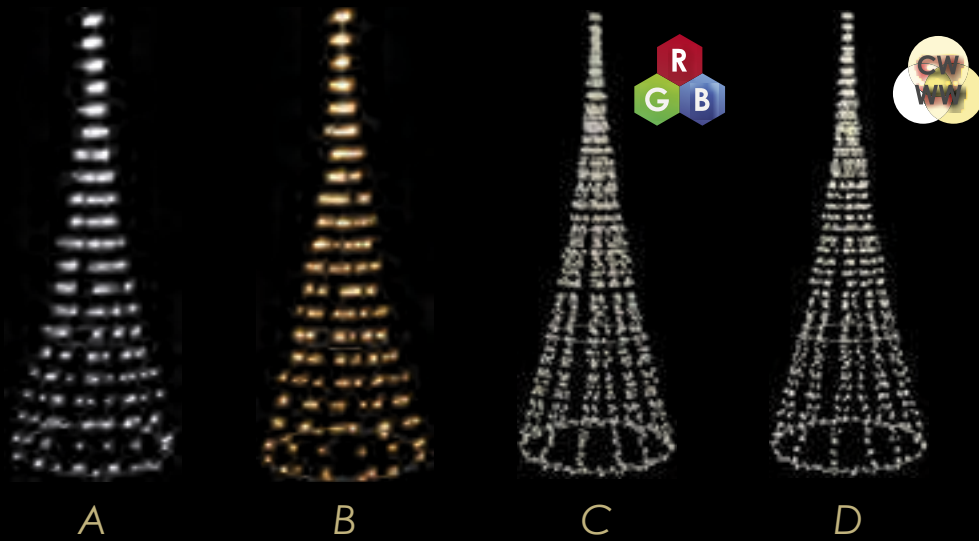

Ø50x150cm

Barcode	Model	String Type	LED Type	Power (W)
444804	A	STRING PLUS	LED	18W
444811	B	STRING PLUS	LED	18W
488891	C	STRING PLUS	LED	28W
510547	D	STRING PLUS	LED	23W

24V	CIII	IP65 IP44 Plug	5kg	155x52x52cm	INC.

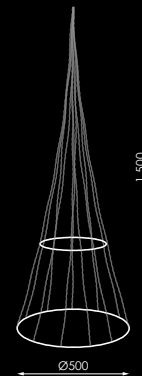

Ø100x250cm

Barcode	Model	String Type	LED Type	Power (W)
416085	A	STRING PLUS	LED	36W
444903	B	STRING PLUS	LED	36W
488921	C	STRING PLUS	LED	46W
510561	D	STRING PLUS	LED	46W

24V	CIII	IP65 IP44 Plug	9kg	255x105x105cm	INC.

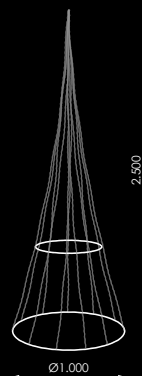



# Cone Loop

3D

Motivo  
Motifs  
Motifs  
Motivos

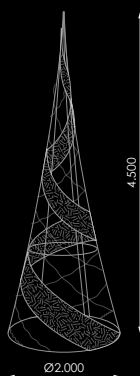
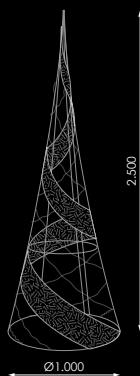
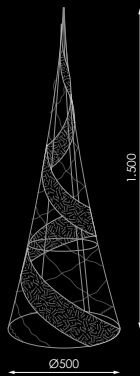
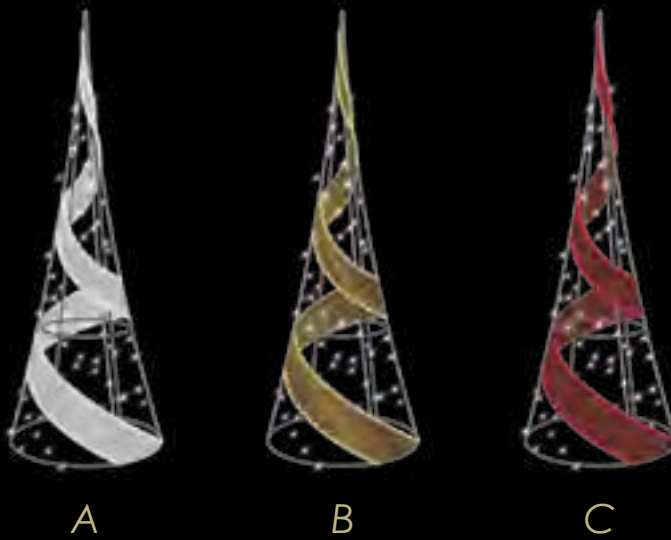

Ø50x150cm						
		1	2			
444651	A	flexi LED	STRING PLUS LED	LED	TAPIZ	White
444668	B	flexi LED	STRING PLUS LED	LED	TAPIZ	Gold
444675	C	flexi LED	STRING PLUS LED	LED	TAPIZ	Red
W	⚡	⚡	⚡	⚡	⚡	⚡
21W	24V	CIII	IP65 IP44 Plug	5kg	155x52x52cm	INC.

Ø100x250cm						
		1	2			
444750	A	flexi LED	STRING PLUS LED	LED	TAPIZ	White
444767	B	flexi LED	STRING PLUS LED	LED	TAPIZ	Gold
444774	C	flexi LED	STRING PLUS LED	LED	TAPIZ	Red
W	⚡	⚡	⚡	⚡	⚡	⚡
48W	24V	CIII	IP65 IP44 Plug	15kg	255x105x105cm	INC.

Ø200x450cm						
		1	2			
545655	A	flexi LED	STRING PLUS LED	LED	TAPIZ	White
545662	B	flexi LED	STRING PLUS LED	LED	TAPIZ	Gold
545679	C	flexi LED	STRING PLUS LED	LED	TAPIZ	Red
W	⚡	⚡	⚡	⚡	⚡	⚡
140W	24V	CIII	IP65 IP44 Plug	35kg	1- 255x52x52cm 1- 205x205x205cm	INC.

[GRÁFICOS: Unidades en mm/ GRÁFICOS: Units in mm/ GRÁFICOS: Unidades em mm/ GRÁFICOS: Unidades em mm]

Saca  
Punta  
a la  
Creatividad

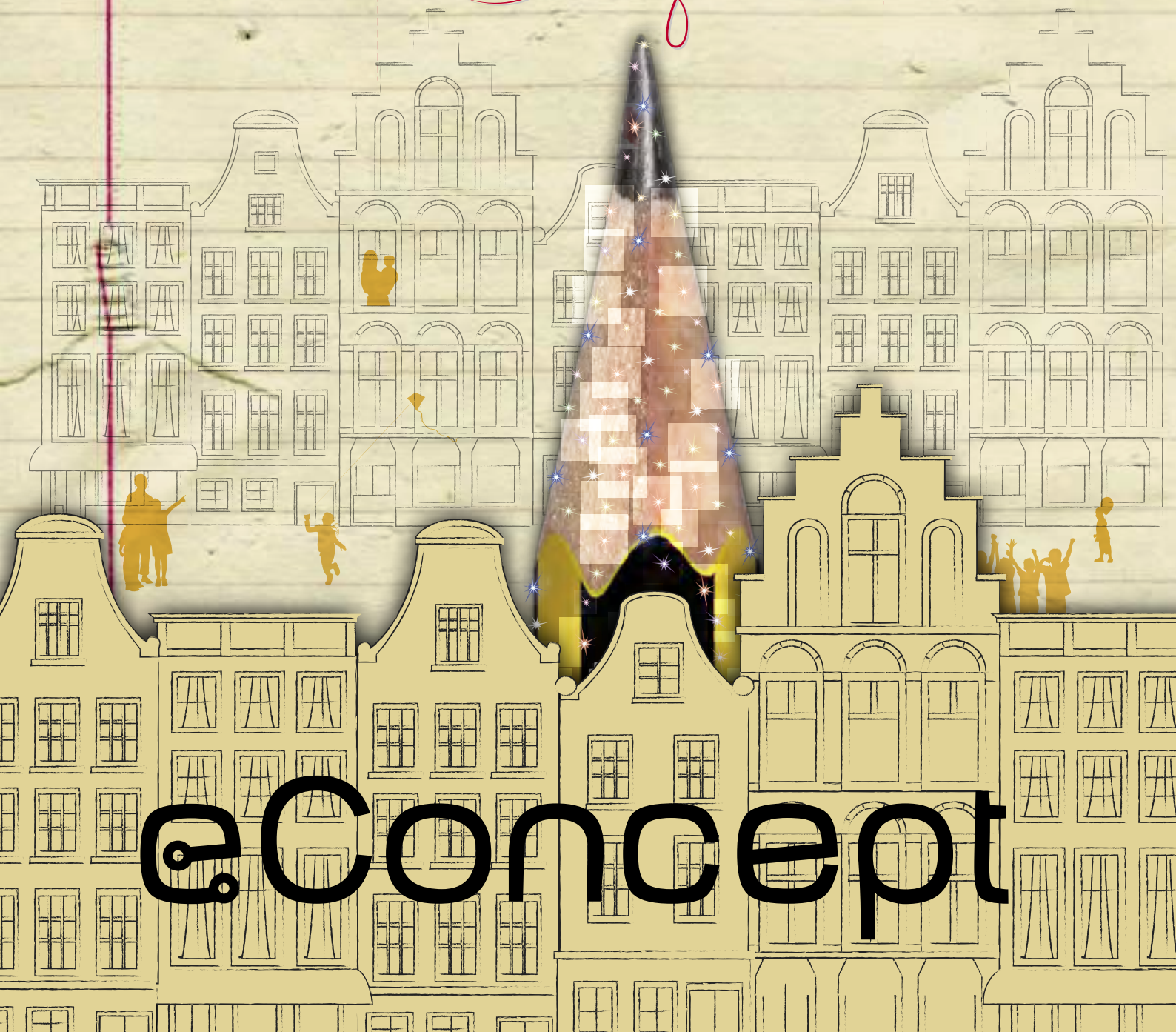

@Concept



# Cone Loop

## PVC NET

3D

Motivo  
Motifs  
Motifs  
Motivos

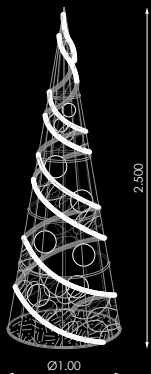

[GRÁFICOS: Unidades en mm/ GRÁFICOS: Units in mm/GRÁFICOS: Unidades en mm/GRÁFICOS: Unidades en mm]



512237	flexi LED	STRING PLUS LED	PVC NET	CHRISTMAS BALL
W				
56W	24V	CIII	IP44	15kg
				255x105x105cm
				INC.

# Cherry Blossom Tree 1,8m

Motivo  
Motifs  
Motifs  
Motivos

3D



Barcode		Lightbulb icon			
210461		LED			
210478		LED			
210485		LED			
506281		LED			
W	⚡	⬡	⊕	☼	⌚
60W	24V	CIII	IP44	800	INC.

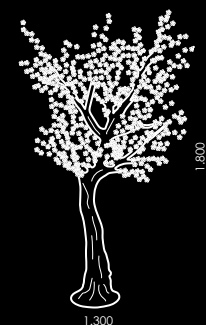



# Cherry Blossom Tree 2,8m

3D

Motivo  
Motifs  
Motifs  
Motivos

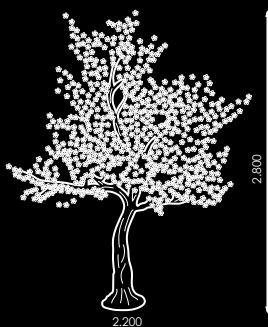











	210492	
	210508	
	210515	
	506298	
<b>W</b>		
150W	24V	CIII
	IP44	2120
		INC.

# Cherry Blossom Tree 3,6m

Motivo  
Motifs  
Motifs  
Motivos

3D



					
408226					
408233					
408240					
<b>W</b>					
300W	24V	CIII	IP44	4100	INC.

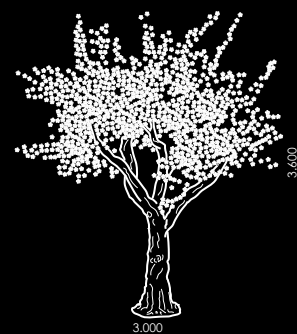

# Cherry Blossom Tree 4,5m

3D

Motivo  
Motifs  
Motifs  
Motivos

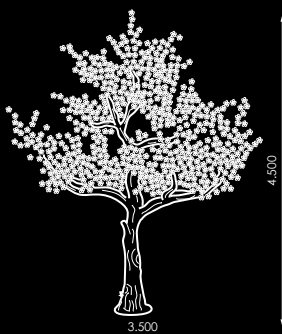

	408257				
	408264				
	408271				
<b>W</b>					
350W	24V	CIII	IP44	5200	INC.





# Maple Tree

Motivo  
Motifs  
Motifs  
Motivos

3D



2,8m



506311



506328



W



100W

24V

CIII

IP44

1376

INC.

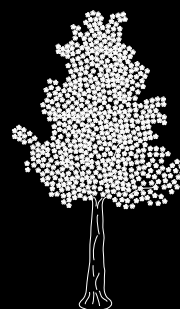

2,800

5m



506335



506342



W



180W

24V

CIII

IP44

2924

INC.

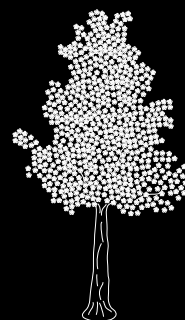

5,000

8m



506359



506397



W



250W

24V

CIII

IP44

4000

INC.

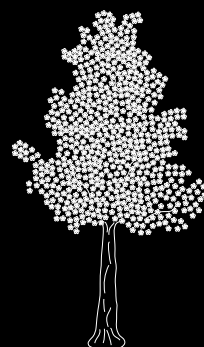

8,000

# Autumn Tree 3,5m

3D

Motivo  
Motifs  
Motifs  
Motivos

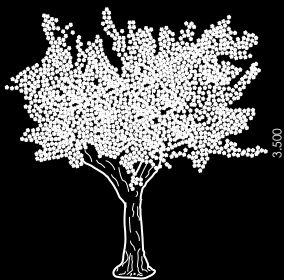

506434					
506441					
<b>W</b> 100W	 24V	 CIII	 IP44	 1664	 INC.



## Información/Information/Information/Informações

**N/** El código 506434 va con hoja blanca y el código 506441 va con hoja otoñal (foto principal).

**E/** Code 506434 goes with a white sheet and code 506441 goes with an autumn leaf (main photo)..

**F/** Le code 506434 va avec une feuille blanche et le code 506441 va avec une feuille d'automne (photo principale).

**P/** EO código 506434 acompanha uma folha em branco e o código 506441 acompanha uma folha de outono (foto principal).



# Valley Tree

Motivo  
Motifs  
Motifs  
Motivos

3D



547796



LED

W

12W



24V



CIII



IP44



400



INC.

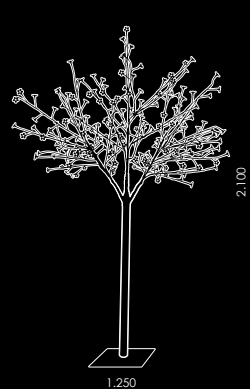



# Giant Tree

3D

Motivo  
Mofifs  
Mofifs  
Mofivos



CC. Plaza Norte - Madrid

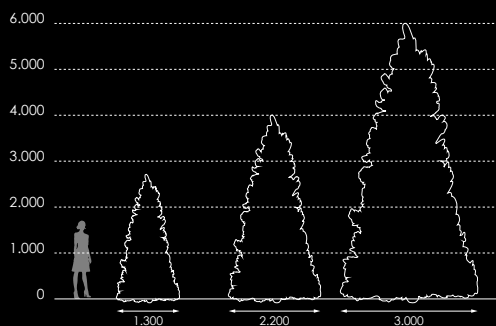

Barcode	Height (m)	Weight (kg)	Number of Cases
412216	2,7m		1
506946	4m	44kg	2
506991	6m	112kg	4



**N/** Estructura de poste interior y base fijación de seguridad.

**E/** Structure of inner pole and base with safety locking.

## Componentes/Components/Composants/Componentes

**F/** Structure du pôle interne et base avec fermeture de sécurité.

**P/** Estrutura do pólo interior e base com bloqueio de segurança.



## Información/Information/Information/Informações

**N/** Este producto se sirve desmontado, embalado en el número de cajas que indica la columna de embalaje. Solo se sirve el árbol, sin decoración.

**E/** This product is disassembled, packed in the number of cases indicating the column packing. Only the tree is served, without decoration.

**F/** Ce produit est démonté, emballé dans le nombre de cas, indiquant l'emballage de la colonne. Seul l'arbre est servi, sans décoration.

**P/** Este produto é desmontado, embalado no número de casos, indicando a embalagem de coluna. Somente a árvore é servida, sem decoração.



# eConcept

El nuevo sistema de control de iluminación dinámica "Prilux econcept" para árboles, fachadas y elementos 3d sincroniza música y luz para crear composiciones visuales espectaculares que aportan ritmo y movimiento a todo tipo de ambientes, espacios y eventos.

"Prilux econcept" Le nouveau système de contrôle d'éclairage dynamique pour arbres, façades et éléments 3D synchronise la musique et la lumière pour créer des compositions visuelles spectaculaires qui apportent du rythme et du mouvement à tous types d'environnements, d'espaces et d'événements.

"Prilux econcept" The new dynamic lighting control system for trees, façades and 3d elements synchronizes music and light to create spectacular visual compositions that bring rhythm and movement to all types of environments, spaces and events.

"Prilux econcept" O novo sistema dinâmico de controle de iluminação para árvores, fachadas e elementos tridimensionais sincroniza música e luz para criar composições visuais espetaculares que trazem ritmo e movimento a todos os tipos de ambientes, espaços e eventos.





# Giant Cone PIXELMAX



**N** Nuevo  
New  
Nouveau  
Novo

Motivo  
Motifs  
Motifs  
Motivos

3D



PIXELMAX



Oviedo



## NO TRANSITABLE

					<b>W</b>	
<b>N 567374</b>	4,965m	STRING PIXELMAX	RGB	12V	1.030W	135kg
<b>489751</b>	6,945m	STRING PIXELMAX	RGB	12V	1.436W	190kg
<b>489768</b>	8,93m	STRING PIXELMAX	RGB	12V	2.360W	280kg
<b>489775</b>	10,92m	STRING PIXELMAX	RGB	12V	3.900W	420kg
<b>489782</b>	12,91m	STRING PIXELMAX	RGB	12V	5.590W	585kg

### Información/Information/Information/Informações



**N**/ Todos los materiales se sirven ya montados, en el Giant Cone PIXELMAX.

**E**/ All materials are served already assembled, in the Giant Cone PIXELMAX.

**F**/ Tous les matériaux sont servis déjà assemblés, dans le Giant Cone PIXELMAX.

**P**/ Todos os materiais são servidos já montados, no Cone Gigante PIXELMAX.



# Giant Cone PIXELMAX

Nuevo  
New  
Nouveau  
Novo

**N**

**3D**

Motivo  
Motifs  
Motifs  
Motivos



PIXELMAX



Gijón



## TRANSITABLE

567381	6,945m	STRING PIXELMAX	RGB	12V	1.316W	185kg
567398	8,93m	STRING PIXELMAX	RGB	12V	2.240W	275kg
567404	10,92m	STRING PIXELMAX	RGB	12V	3.780W	415kg
567411	12,91m	STRING PIXELMAX	RGB	12V	5.470W	580kg
567428	20,9m	STRING PIXELMAX	RGB	12V	12.500W	1.436kg



### Información/Information/Information/Informações

**N/** Todos los materiales se sirven ya montados, en el Giant Cone PIXELMAX.

**E/** All materials are served already assembled, in the Giant Cone PIXELMAX.

**F/** Tous les matériaux sont servis déjà assemblés, dans le Giant Cone PIXELMAX.

**P/** Todos os materiais são servidos já montados, no Cone Gigante PIXELMAX.

# Giant Cone PIXELMAX RINGS



**N** Nuevo  
New  
Nouveau  
Novo

Motivo  
Motifs  
Motifs  
Motivos

3D



PIXELMAX



567435	8,33m	9,11m	STRING PIXELMAX	RGB	12V/230V	1.600W	275kg
567442	10,32m	11,49m	STRING PIXELMAX	RGB	12V/230V	2.075W	415kg
567459	12,31m	13,48m	STRING PIXELMAX	RGB	12V/230V	3.765W	580kg

## Información/Information/Information/Informações



**Ñ/** Todos los materiales se sirven ya montados en el GIANT CONE PIXELMAX RINGS y por separado, en los Giant Cone RGB y CW-WW.

**E/** All the materials are served already assembled in the GIANT CONE PIXELMAX RINGS and separately, in the Giant Cone RGB and CW-WW.

**F/** Tous les matériaux sont servis déjà assemblés dans les ANNEAUX GIANT CONE PIXELMAX et séparément, dans le Giant Cone RGB et CW-WW.

**P/** Todos os materiais são servidos já montados nos GIGANTES CONE PIXELMAX RINGS e separadamente, no Giant Cone RGB e CW-WW.

## Aviso/Warning/Avertissement/Aviso



**Ñ/** Sólo será transitable el modelo de 12m.

**E/** Only the 12m model will be passable.

**F/** Seul le modèle 12m sera praticable.

**P/** Apenas o modelo de 12m será transitável.



# Giant Cone

## RGB

3D

Motivo  
Motifs  
Motifs  
Motivos

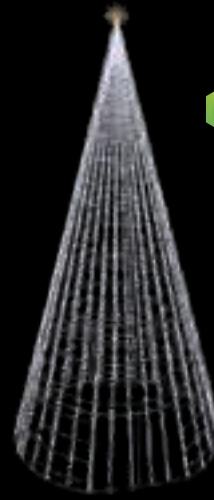

EJEMPLOS DE OPCIONES POSIBLES/ EXAMPLES OF POSSIBLE OPTIONS/  
EXEMPLES D'OPTIONS POSSIBLES/ EXEMPLOS DE POSSÍVEIS OPÇÕES

						<b>W</b>	
489799	6,34m	7,12m	STRING PLUS	RGB	230V	250W	141kg
489805	8,33m	9,11m	STRING PLUS	RGB	230V	405W	200kg
489812	10,32m	11,49m	STRING PLUS	RGB	230V	625W	315kg
489829	12,31m	13,48m	STRING PLUS	RGB	230V	780W	460kg

# Giant Cone

## CW-WW

3D

Motivo  
Motifs  
Motifs  
Motivos



EJEMPLOS DE OPCIONES POSIBLES/ EXAMPLES OF POSSIBLE OPTIONS/  
EXEMPLES D'OPTIONS POSSIBLES/ EXEMPLOS DE POSSÍVEIS OPÇÕES

						<b>W</b>	
511612	6,34m	7,12m	STRING PLUS	CW-WW	230V	250W	141kg
511629	8,33m	9,11m	STRING PLUS	CW-WW	230V	405W	200kg
511636	10,32m	11,49m	STRING PLUS	CW-WW	230V	625W	315kg
511643	12,31m	13,48m	STRING PLUS	CW-WW	230V	780W	460kg

# Giant Cone

## SILENE (con recubrimiento)



Motivo  
Motifs  
Motifs  
Motivos

3D



		+ LILIUM		<b>W</b>	
489867	10,32m	11,49m	SILENE + OKRA + STRING PLUS FLASHING	1.088W	526kg

# Giant Cone

## DOUBLE STAR (con recubrimiento)



Motivo  
Motifs  
Motifs  
Motivos

3D



		+ LILIUM		<b>W</b>	
489874	10,32m	11,49m	DOUBLE STAR + STRING PLUS + RED METALLIC BRANCH + LAMPARA FLASH	1.302W	574kg





# Giant Cone

## TEARS (con recubrimiento)

Nuevo  
New  
Nouveau  
Novo

N

3D

Motivo  
Motifs  
Motifs  
Motivos



				<b>W</b>	
<b>567466</b>	6,34m	7,12m	TEARS WW + STRING PLUS RED + RED METALLIC BRANCH	558W	208kg
<b>567473</b>	8,33m	9,11m	TEARS WW + STRING PLUS RED + RED METALLIC BRANCH	838W	361kg
<b>567480</b>	10,32m	11,49m	TEARS WW + STRING PLUS RED + RED METALLIC BRANCH	1.212W	534kg



### Información/Information/Information/Informações

**N/** Todos los materiales de los GIANT CONE con y sin RECUBRIMIENTO se sirven por separado, excepto el STRING PLUS CW y el STRING PLUS CW ESTRELLAS, que se sirve montado el string plus.

**E/** All GIANT CONE materials with and without COATING are served separately, except for the STRING PLUS CW and the STRING PLUS CW ESTRELLAS, which is fitted with the string plus.

**F/** Tous les matériaux GIANT CONE avec et sans COATING sont servis séparément, à l'exception du STRING PLUS CW et du STRING PLUS CW ESTRELLAS, équipé du string plus.

**P/** Todos os materiais do GIANT CONE com e sem o COATING são servidos separadamente, exceto o STRING PLUS CW e o STRING PLUS CW ESTRELLAS, que é equipado com o string plus.

[GRÁFICOS: Unidades en mm/ GRÁFICOS: Units in mm/ GRÁFICOS: Unidades em mm/ GRÁFICOS: Unidades em mm]

# Giant Cone

## RGB DOUBLE STAR (sin recubrimiento)



Motivo  
Motifs  
Motifs  
Motivos

3D



Villaviciosa - Asturias



EJEMPLOS DE OPCIONES POSIBLES/ EXAMPLES OF POSSIBLE OPTIONS/  
EXEMPLES D'OPTIONS POSSIBLES/ EXEMPLOS DE POSSÍVEIS OPÇÕES

Barcode	Height	Width + LILIUM	String Type	Color	Light Type	Voltage	Power	Weight
511650	8,33m	9,11m	STRING PLUS	RGB	Double Star/ Lámpara FLASH E27	230V	812W	265kg
511667	10,32m	11,49m	STRING PLUS	RGB	Double Star/ Lámpara FLASH E27	230V	1.179W	404kg
511674	12,31m	13,48m	STRING PLUS	RGB	Double Star/ Lámpara FLASH E27	230V	1.537W	610kg



# Giant Cone

## STAR FLAKE (sin recubrimiento)

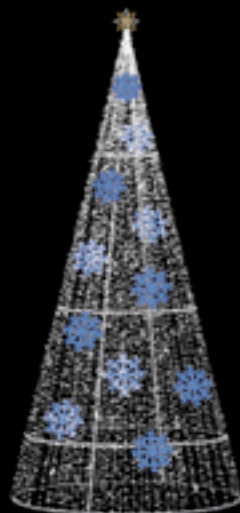

3D

Motivo  
Motifs  
Motifs  
Mofivos



				<b>W</b>	
453653	8,33m	9,11m	BLANCO STAR FLAKE	1.091W	255kg
453721	10,32m	11,49m	BLANCO STAR FLAKE	1.291W	370kg
453790	12,31m	13,48m	BLANCO STAR FLAKE	1.827W	558kg



# Giant Cone

## STRING CW (sin recubrimiento)



3D

Motivo  
Motifs  
Motifs  
Mofivos



				<b>W</b>	
489904	6,34m	7,12m	STRING PLUS CW	293W	120kg
489911	8,33m	9,11m	STRING PLUS CW	535W	190kg
469067	10,32m	11,49m	STRING PLUS CW	815W	310kg
489928	12,31m	13,48m	STRING PLUS CW	1.130W	475kg
489935	14,3m	15,47m	STRING PLUS CW	1.730W	773kg

# Giant Cone

## SPIRAL TAPIZ ROJO (sin recubrimiento)



Motivo  
Motifs  
Motifs  
Motivos

3D



Barcode	+	+ LILIUM	Lighting	W	kg
511681	8,33m	9,11m	STRING PLUS CW + TAPIZ ROJO	439W	260kg
511698	10,32m	11,49m	STRING PLUS CW + TAPIZ ROJO	659W	405kg
511704	12,31m	13,48m	STRING PLUS CW + TAPIZ ROJO	813W	610kg

# Giant Cone

## SPIRAL GOLD (sin recubrimiento)



Motivo  
Motifs  
Motifs  
Motivos

3D

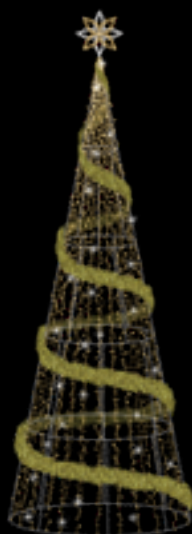

Barcode	+	+ LILIUM	Lighting	W	kg
511711	8,33m	9,11m	STRING PLUS WW + GUIRNALDA DORADA + LÁMAPARA FLASH	651W	265kg
511766	10,32m	11,49m	STRING PLUS WW + GUIRNALDA DORADA + LÁMAPARA FLASH	947W	415kg
511773	12,31m	13,48m	STRING PLUS WW + GUIRNALDA DORADA + LÁMAPARA FLASH	1.233W	625kg



# Giant Cone

STRING ESTRELLAS (sin recubrimiento)

3D

Motivo  
Motifs  
Motifs  
Motivos



San Sebastian de los Reyes - Madrid



		+ LILIUM		W	
489942	8,33m	9,11m	STRING PLUS CW + 21 ESTRELLAS	1.085W	260kg
489959	10,32m	11,49m	STRING PLUS CW + 29 ESTRELLAS	1.565W	402kg
467520	12,31m	13,48m	STRING PLUS CW + 37 ESTRELLAS	2.005W	591kg

[GRÁFICOS: Unidades en mm/ GRÁFICOS: Units in mm/ GRÁFICOS: Unidades en mm/ GRÁFICOS: Unidades en mm]

# Basic Gift

## BOX



**N** Nuevo  
New  
Nouveau  
Novo

Motivo  
Motifs  
Motifs  
Motivos

**3D**



  
PIXELMAX



					<b>W</b>	
<b>565134</b>	3,4x3,4x3,4m	STRING PIXELMAX	RGB	12V	1.800W	150kg
<b>565127</b>	3,4x3,4x3,4m	STRING PLUS	WW FLASHING	24V	240W	130kg
<b>565141</b>	3,4x3,4x3,4m	STRING PLUS	BLUE FLASHING	24V	240W	130kg

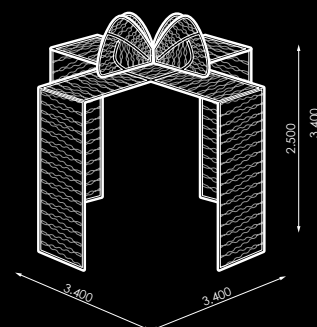



# Big Gift BOX

Nuevo  
New  
Nouveau  
Novo

**N**

**3D**

Motivo  
Motifs  
Motifs  
Motivos



PIXELMAX

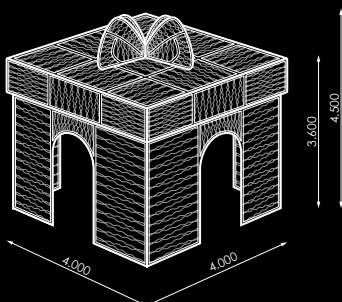
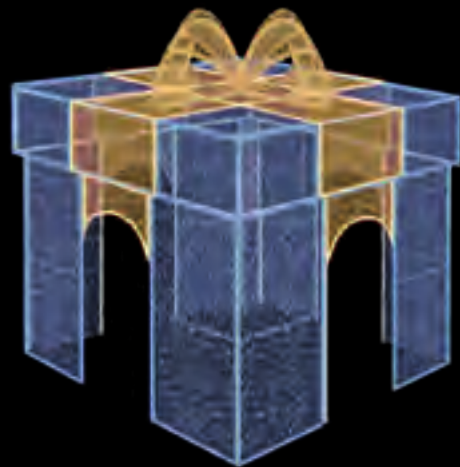
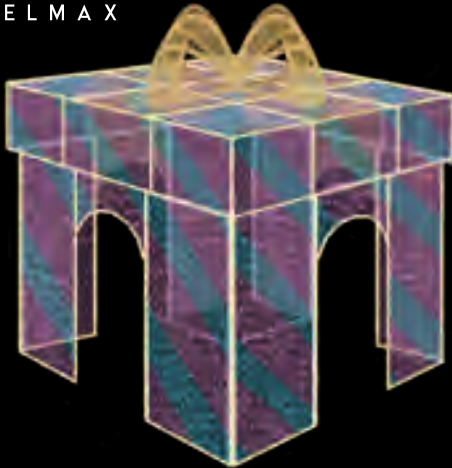

					<b>W</b>	
<b>565233</b>	4x4x4,5m	STRING PIXELMAX	RGB	12V/24V	3.298W	350kg
<b>565240</b>	4x4x4,5m	STRING PLUS	RGB (LAZO WW)	24V	800W	340kg
<b>565226</b>	4x4x4,5m	STRING PLUS FLASHING	BLUE (LAZO WW)	24V	720W	320kg

[GRÁFICOS: Unidades en mm/ GRÁFICOS: Units in mm/GRAPHIQUES: Unités en mm/GRÁFICOS: Unidades em mm]

# Giant Ball PIXELMAX



**N** Nuevo  
New  
Nouveau  
Novo

Motivo  
Motifs  
Motifs  
Motivos

3D



						<b>W</b>	
567503	2,8x2,6m	STRING PIXELMAX	flexi LED	LED	12V/24V	1.570W	127kg

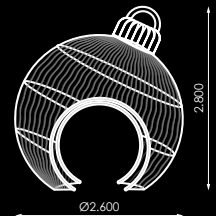

						<b>W</b>	
567497	4,3x4m	STRING PIXELMAX	flexi LED	LED	12V/24V	2.700W	196kg

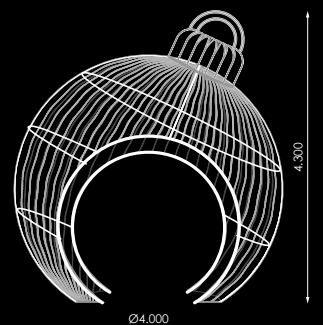





# Giant Ball

## STARS

Nuevo  
New  
Nouveau  
Novo

N

3D

Motivo  
Motifs  
Motifs  
Mótvos

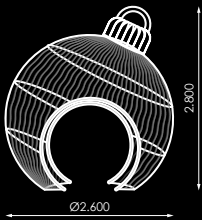

Barcode	Dimensions	Light Type	LED Type	LED Type	Voltage	Power	Weight
567527	2,8x2,6m	STRING PLUS FLASHING	flexi LED	STRING LED	24V	210W	105kg
567541	2,8x2,6m	STRING PLUS FLASHING	flexi LED	STRING LED	24V	210W	105kg

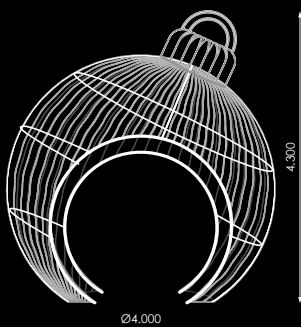

Barcode	Dimensions	Light Type	LED Type	LED Type	Voltage	Power	Weight
567510	4,3x4m	STRING PLUS FLASHING	flexi LED	STRING LED	24V	375W	178kg
567534	4,3x4m	STRING PLUS FLASHING	flexi LED	STRING LED	24V	375W	178kg

[GRÁFICOS: Unidades en mm/ GRÁFICOS: Units in mm/ GRÁFICOS: Unidades en mm/ GRÁFICOS: Unidades en mm]

# Alas Tinkerbell

## SELFIE



**N** Nuevo  
New  
Nouveau  
Novo

Motivo  
Motifs  
Motifs  
Motivos

3D



		<b>1</b>	<b>2</b>		
561334	flexi	STRING	TAPIZ	STRING	
<b>W</b>					
125W	24V	CIII	IP65 IP44 Plug	40kg	INC.

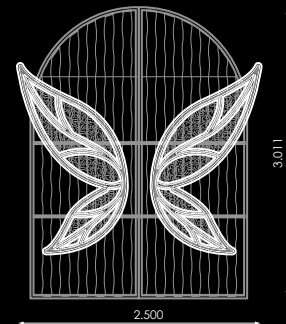

# Alas Ángel

## SELFIE



**N** Nuevo  
New  
Nouveau  
Novo

Motivo  
Motifs  
Motifs  
Motivos

3D



		<b>1</b>	<b>2</b>		
562089	flexi	STRING	TAPIZ	STRING	
<b>W</b>					
135W	24V	CIII	IP65 IP44 Plug	42kg	INC.

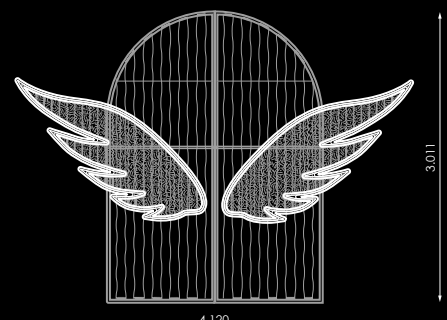



# Penguin SELFIE

Nuevo  
New  
Nouveau  
Novo **N**

3D **Motivo**  
Motifs  
Motifs  
Motivos

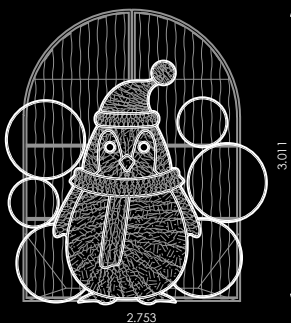

562638	flexi LED	TAPIZ	STRING PLUS LED		
160W	24V	CIII	IP65 IP44 Plug	44kg	INC.

[GRÁFICOS: Unidades en mm/ GRÁFICOS: Units in mm/ GRAPHIQUES: Unités en mm/ GRÁFICOS: Unidades em mm]

# Photocall Elf



Motivo  
Motifs  
Motifs  
Motivos

3D



512206	flexi	TAPIZ			
<b>W</b>					
361W	24V (XMAS) 230V (Resto)	CII	IP65 IP44 Plug	125kg	INC.



# Photocall Reindeer



3D

Motivo  
Motifs  
Motifs  
Motivos



[GRÁFICOS: Unidades en mm/ GRÁFICOS: Units in mm/GRÁFICOS: Unidades em mm/GRÁFICOS: Unidades em mm]



512213	flexi	LED	LED	TAPIZ
342W	24V (XMAS) 230V (Resto)	CII	IP65 IP44 Plug	125kg
				INC.

Motivo  
Motifs  
Motifs  
Motivos

3D



Barcode	Icon	1	2
511315	flexi LED	TAPIZ	STRING LED
511322	flexi LED	TAPIZ	STRING LED
W	⚡	⊕	⚖
726W	24V	IP44	220kg
			(2x) 205x55x55cm (2x) 180x105x55cm (2x) 175x155x10cm
			INC.

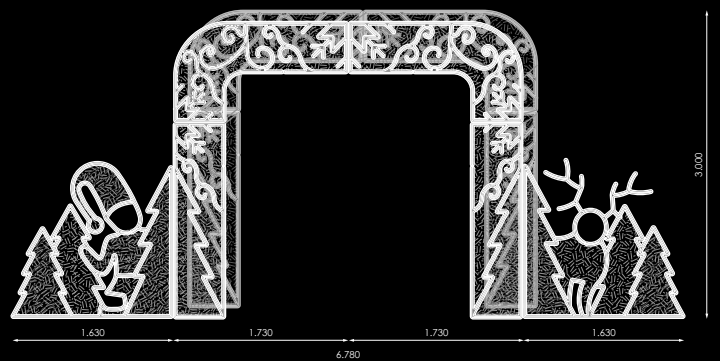

3,000



# Semibola

## TRANSITABLE

3D

Motivo  
Motifs  
Motifs  
Motivos

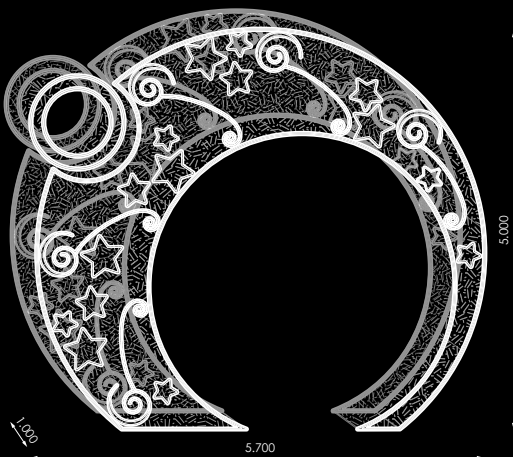

[GRÁFICOS: Unidades en mm/ GRÁFICOS: Units in mm/GRÁFICOS: Unités en mm/GRÁFICOS: Unidades em mm]



		□	■	⚡	W	⚖	
511520	flexi	LED	LED	TAPIZ	24V	507W	283kg
511544	flexi	LED	LED	TAPIZ	24V	507W	283kg

# Bear PORTAL



**N** Nuevo  
New  
Nouveau  
Novo

Motivo  
Motifs  
Motifs  
Motivos

3D



		<b>1</b>	<b>2</b>		
567558	flexi	STRING	PVC NET		
<b>W</b>					
750W	24V	CIII	IP65 IP44 Plug	250kg	INC.

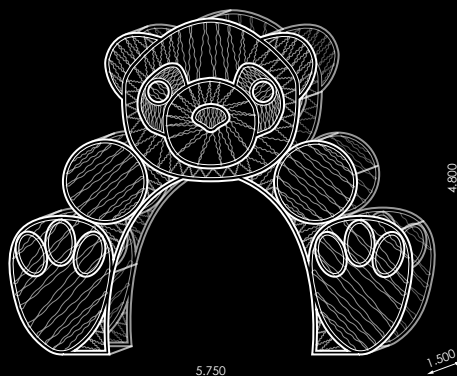





# Penguin PORTAL

Nuevo  
New  
Nouveau  
Novo

**N**

**3D**

Motivo  
Motifs  
Motifs  
Motivos

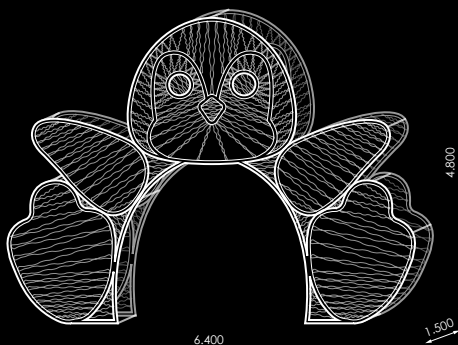
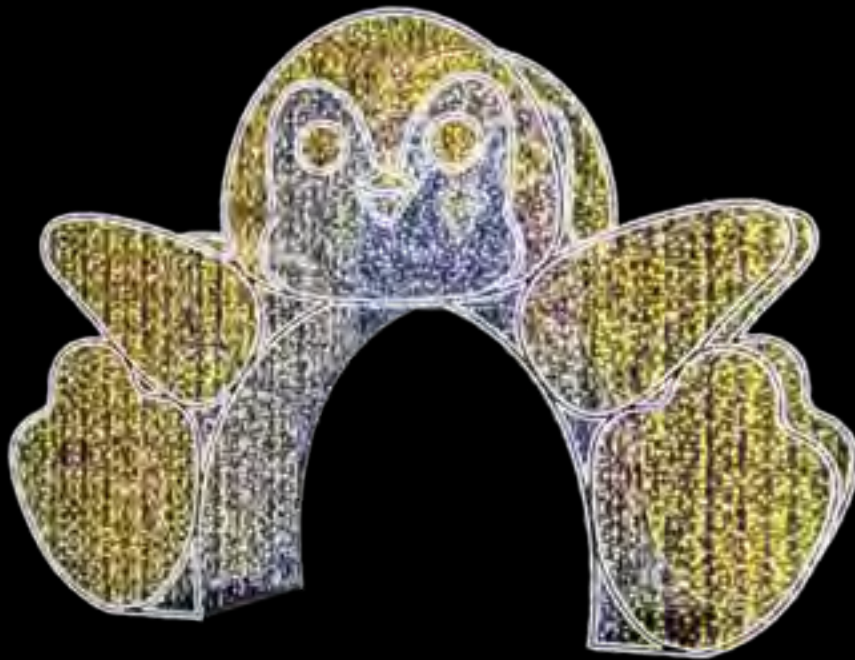

567565	flexi LED	STRING PLUS LED LED	PVC NET		
<b>W</b>					
720W	24V	CIII	IP65 IP44 Plug	245kg	INC.

[GRÁFICOS: Unidades en mm/ GRÁFICOS: Units in mm/ GRAPHIQUES: Unités en mm/ GRÁFICOS: Unidades em mm]

# Xmas PORTAL



**N** Nuevo  
New  
Nouveau  
Novo

Motivo  
Motifs  
Motifs  
Motivos

**3D**



		<b>1</b>	<b>2</b>		
567572	flexi LED	STRING PLUS LED LED LED	PVC NET		
<b>W</b>					
550W	24V	CIII	IP65 IP44 Plug	210kg	INC.

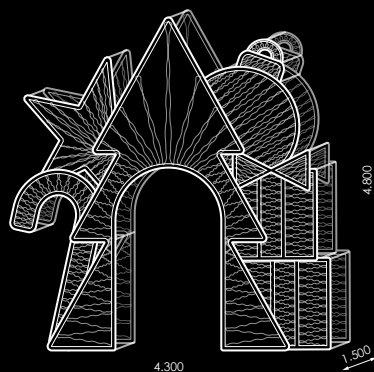





**Cuidad de Funchal, Isla de Madeira (Portugal)**  
by TC Luz & Eventos  
Producto Prilux



# Tunel TRANSITABLE

Nuevo  
New  
Nouveau  
Novo **N**

**3D**

Motivo  
Motifs  
Motifs  
Motivos

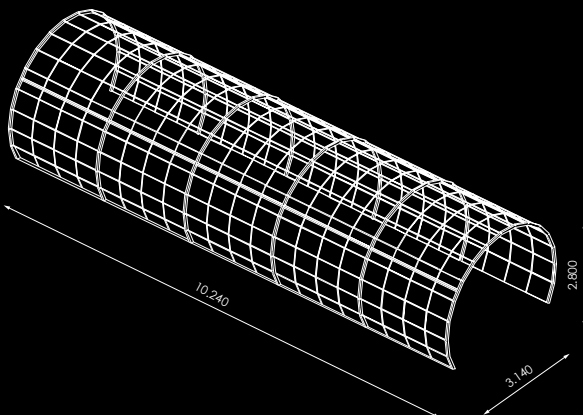

	(X-Y-Z)			<b>W</b>	
<b>511247</b>	3,14x2,80x10,24m	STRING PIXELMAX RGB	12V	4.980W	350kg
<b>511254</b>	3,14x2,80x10,24m	STRING PLUS CW-WW	230V	690W	290kg
<b>511261</b>	3,14x2,80x10,24m	STRING PLUS RGB	230V	690W	290kg
<b>511278</b>	3,14x2,80x10,24m	STRING PLUS CW FLASHING	24V	490W	295kg
<b>511285</b>	3,14x2,80x10,24m	STRING PLUS WW FLASHING	24V	490W	295kg

[GRÁFICOS: Unidades en mm/ GRÁFICOS: Units in mm/ GRÁFICOS: Unités en mm/ GRÁFICOS: Unidades em mm]

**N** Nuevo  
New  
Nouveau  
Novo

Motivo  
Motifs  
Motifs  
Motivos

**3D**



CC. As Cancelas -  
Santiago de Compostela



		1	2		
567589	flexi LED	STRING PLUS LED	TAPIZ		
567596	flexi LED	STRING PLUS LED	TAPIZ		
W	⚡	□	⊙	⚖	⌚
140W	230V	CII	IP65 IP44 Plug	32kg	INC.

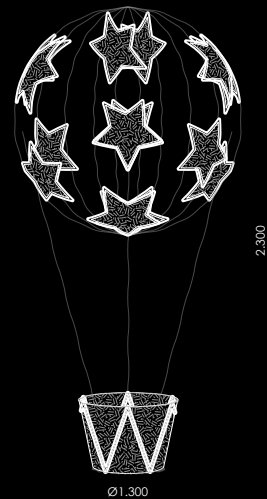



# Globo Bahín Maxibrillo

Nuevo  
New  
Nouveau  
Novo **N**

3D

Motivo  
Motifs  
Motifs  
Motivos



CC. Ribera del Xuquer - Valencia

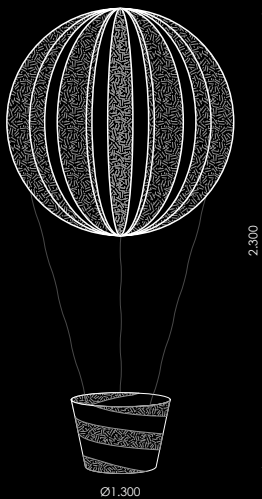

		<b>1</b>	<b>2</b>
454643	flexi	STRING <b>PLUS</b>	TAPIZ
459075	flexi	STRING <b>PLUS</b>	TAPIZ
<b>W</b>			
416W	230V	CII	IP65 IP44 PLUG
			30kg
			INC.















[GRÁFICOS: Unidades en mm/ GRÁFICOS: Units in mm/ GRÁFICOS: Unités en mm/ GRÁFICOS: Unidades em mm]

Motivo  
Motifs  
Motifs  
Motivos

3D







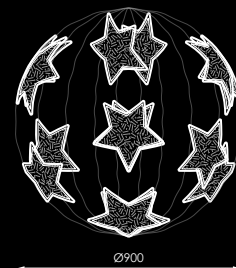









### Ø90cm

		1	2
			
446310	flexi 	STRING  	TAPIZ 
446327	flexi 	STRING  	TAPIZ 
<b>W</b>			
73W	230V	CII	IP65 IP44 Plug
			
		6kg	95x95x65cm
			INC.



### Ø130cm

		1	2
			
446358	flexi 	STRING  	TAPIZ 
446365	flexi 	STRING  	TAPIZ 
<b>W</b>			
105W	230V	CII	IP65 IP44 Plug
			
		12.5kg	135x135x85cm
			INC.

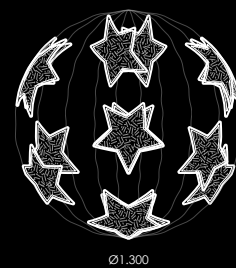





# Bahín Maxibrillo

3D

Motivo  
Motifs  
Motifs  
Motivos

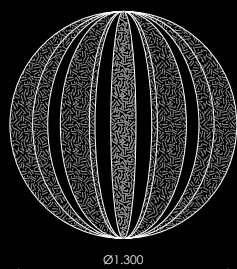
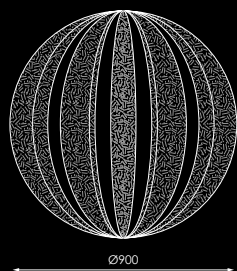

Ø90cm						
444958	flexi LED	TAPIZ				
444965	flexi LED	TAPIZ				
444972	flexi LED	TAPIZ				
<b>W</b>						
277W	230V	CII	IP65 IP44 Plug	6,5kg	95x95x65cm	INC.

Ø130cm						
445009	flexi LED	TAPIZ				
445016	flexi LED	TAPIZ				
445023	flexi LED	TAPIZ				
<b>W</b>						
378W	230V	CII	IP65 IP44 Plug	11kg	135x135x85cm	INC.

[GRÁFICOS: Unidades en mm/ GRÁFICOS: Units in mm/ GRÁFICOS: Unidades en mm/ GRÁFICOS: Unidades en mm]

Motivo  
Motifs  
Motifs  
Motivos

## 3D



Galdar, Las Palmas - Gran Canarias

Ø50cm			
Barcode	Light Icon	W	
445771	STRING PLUS LED	8W	
445764	STRING PLUS LED	8W	
445795	STRING PLUS LED	8W	
445788	STRING PLUS LED	8W	
488853	STRING PLUS LED	9,2W	
510585	STRING PLUS LED	9,2W	
⚡	□	⦿	⚖
230V	CII	IP65 IP44 Plug	2kg
🔗		🔌	
53x53x53cm		INC.	

Ø90cm			
Barcode	Light Icon	W	
445467	STRING PLUS LED	14W	
445450	STRING PLUS LED	14W	
445528	STRING PLUS LED	14W	
445511	STRING PLUS LED	14W	
488860	STRING PLUS LED	18,5W	
510592	STRING PLUS LED	18,5W	
⚡	□	⦿	⚖
230V	CII	IP65 IP44 Plug	4kg
🔗		🔌	
93x93x40cm		INC.	

Ø130cm			
Barcode	Light Icon	W	
445481	STRING PLUS LED	27W	
445474	STRING PLUS LED	27W	
445542	STRING PLUS LED	27W	
445535	STRING PLUS LED	27W	
488877	STRING PLUS LED	37W	
510608	STRING PLUS LED	37W	
⚡	□	⦿	⚖
230V	CII	IP65 IP44 Plug	6kg
🔗		🔌	
133x133x50cm		INC.	

Ø160cm			
Barcode	Light Icon	W	
445504	STRING PLUS LED	34W	
445498	STRING PLUS LED	34W	
445566	STRING PLUS LED	34W	
445559	STRING PLUS LED	34W	
488884	STRING PLUS LED	46W	
510615	STRING PLUS LED	46W	
⚡	□	⦿	⚖
230V	CII	IP65 IP44 Plug	7,5kg
🔗		🔌	
163x163x60cm		INC.	

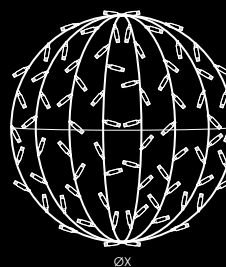

### Información/Information/Information/Informações



Ñ/ Motivo 3D PLEGABLE

E/ 3D FOLDING motive

F/Motif 3D Pliable

P/ Motivo 3D DOBRÁVEL



# 3D Lamps



Motivo  
Motifs  
Motifs  
Motivos

3D



A

B

C



Barcode	Model	LED Type	String Type	Power (W)
510516	A	flexi LED	STRING PLUS LED	166W
510523	B	flexi LED	STRING PLUS LED	140W
510530	C	flexi LED	STRING PLUS LED	140W

⚡	□	⊙	⚖	📦	🔌
230V	CII	IP65 IP44 Plug	15,5kg	(3x) 210x74x10cm	INC.



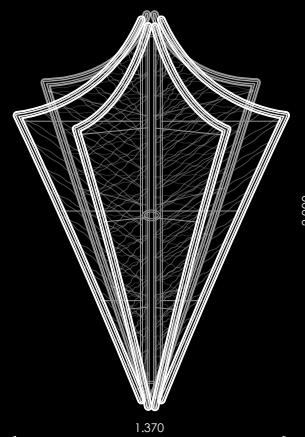

# 3D Stars

3D

Motivo  
Motifs  
Motifs  
Motivos



A



B



C

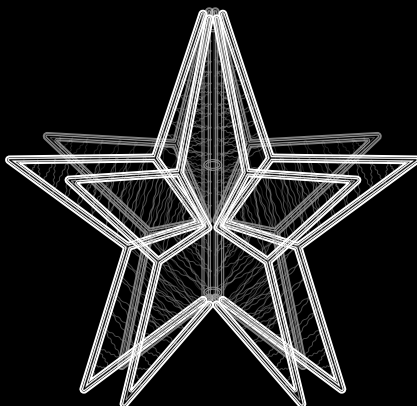

		1	2	W
510486	A flexi LED	STRING PLUS LED	PVC NET	276W
510493	B flexi LED	STRING PLUS LED	PVC NET	186W
510509	C flexi LED	STRING PLUS LED	PVC NET	186W

230V	CII	IP65 IP44 PLUG	22kg	(3x) 200x110x10cm	INC.

[GRÁFICOS: Unidades en mm/ GRÁFICOS: Units in mm/GRÁFICOS: Unités en mm/GRÁFICOS: Unidades em mm]

# Renos

## 3D TAPIZ



**N** Nuevo  
New  
Nouveau  
Novo

Motivo  
Motifs  
Motifs  
Motivos

3D



563086	flexi	STRING	TAPIZ		
<b>W</b>					
95W	24V	CIII	IP65 IP44 Plug	35kg	INC.

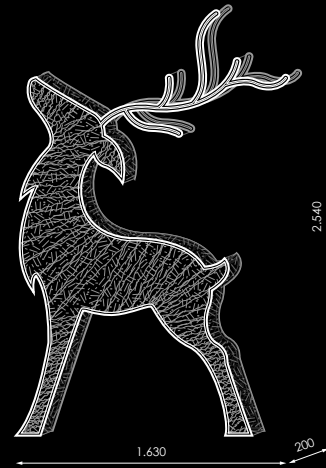

563093	flexi	STRING	TAPIZ		
<b>W</b>					
90W	24V	CIII	IP65 IP44 Plug	30kg	INC.

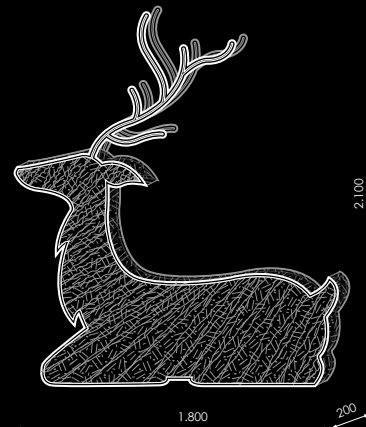

563109	flexi	STRING	TAPIZ		
<b>W</b>					
95W	24V	CIII	IP65 IP44 Plug	34kg	INC.

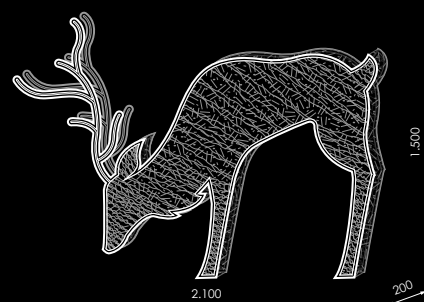



# Reno 3D

**N** Nuevo  
New  
Nouveau  
Novo

Motivo  
Motifs  
Motifs  
Motivos

3D

90cm



120cm



180cm



563253		0,9m			
<b>W</b>					
3,6W	31V	CIII	IP44	120	INC.



900

563246		1,2m			
<b>W</b>					
6W	31V	CIII	IP44	240	INC.



1.200

563284		1,8m			
<b>W</b>					
7,2W	31V	CIII	IP44	360	INC.



1.800

Información/Information/Information/Informações



Ñ/ Estructura blanca metálica.

E/ White metal structure.

F/ Structure métallique blanche.

P/ Estructura de metal branco.





# Nacimiento 3D



Motivo  
Motifs  
Motifs  
Motivos

3D



511339	flexi	STRING PLUS	TAPIZ		
<b>W</b>					
259W	24V	CIII	IP44	62kg	INC.

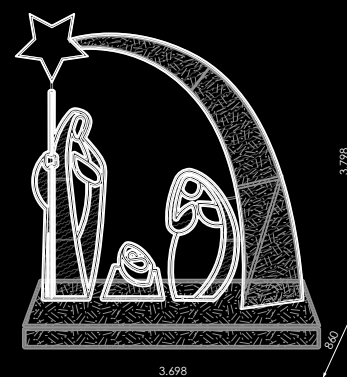



# Nacimiento 3D

## COMPLETO

3D

Motivo  
Motifs  
Motifs  
Mотивos



[GRÁFICOS: Unidades en mm/ GRÁFICOS: Units in mm/ GRAPHIQUES: Unités en mm/ GRÁFICOS: Unidades em mm]

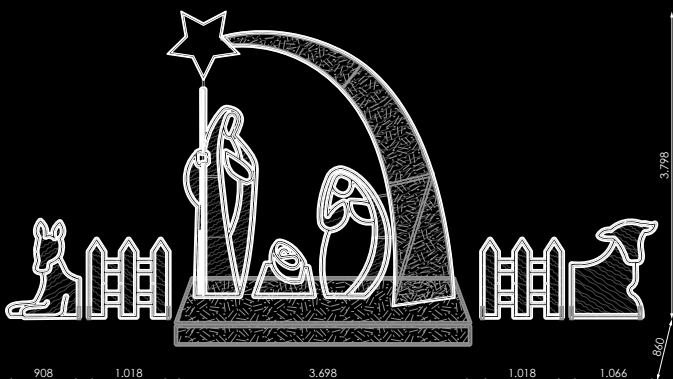

		<b>1</b>	<b>2</b>
511353	flexi	STRING PLUS	TAPIZ
<b>W</b>			
402W	24V	CIII	IP44
			79kg
			INC.

# Nacimiento



Motivo  
Motifs  
Motifs  
Motivos

3D



Canarias



551946	
227W	230V
CII	IP44
INC.	

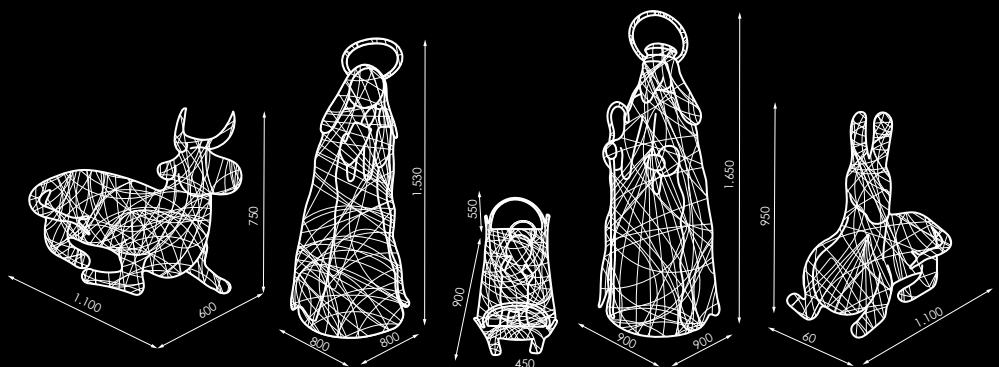

# Nacimiento grande



3D

Motivo  
Motifs  
Motifs  
Motivos



[GRÁFICOS: Unidades en mm/ GRAPHICS: Units in mm/ GRAPHIQUES: Unités en mm/ GRÁFICOS: Unidades em mm]

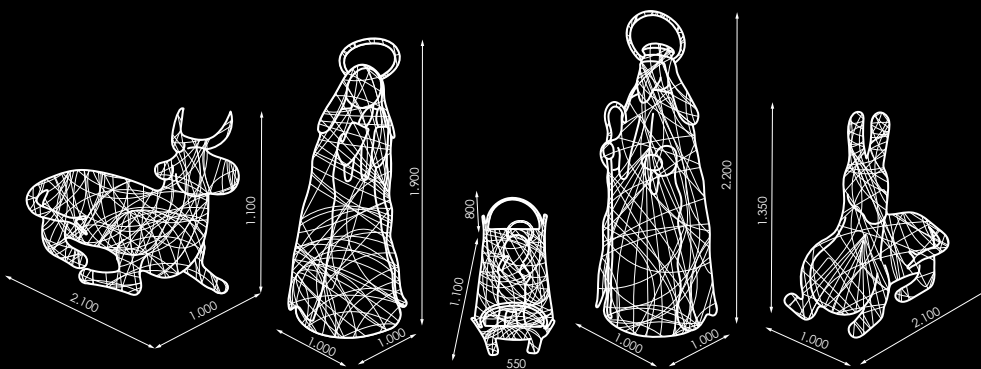

365239	LED			
W				
350W	230V	CII	IP44	INC.

# *Sistemas dinámicos*

---

*Dynamic systems*

*Systèmes dynamiques*

*Sistemas dinâmicos*

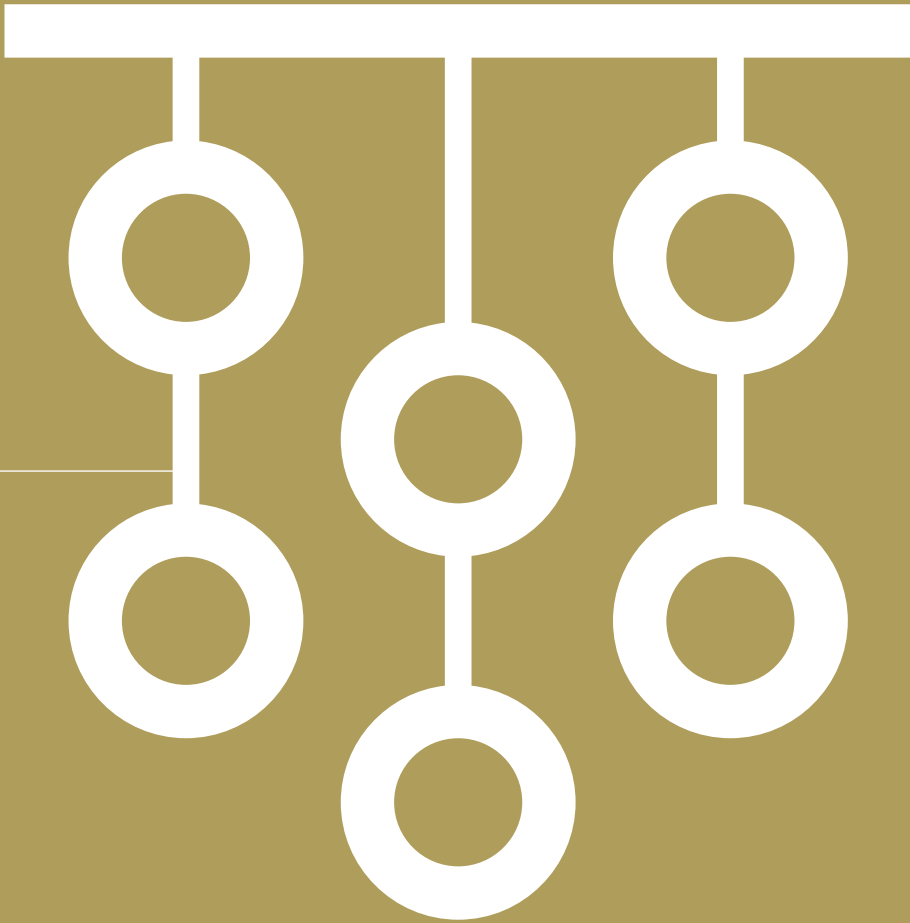

# flexiLIGHT LED

## RGB



CC As Cancelas -  
Santiago de Compostela

230V dc

CII

IP65

360°

-20°C~+60 °C

NO INC.

NO INC.

**Ñ/ EXTERIOR/TEXTURA LISA/TAPA FINAL INCLUIDA E/ OUTSIDE/SMOOTH TEXTURE/END COVER INCLUDED F/ À L'EXTERIEUR/TEXTURE LISSE/COUVERCLE INCLUS P/ EXTERIOR/TEXTURA LISA/TAMPA FINAL INCLUIDA**

546676		

	1m
	13mm
	36
	4,6W
<b>W</b>	184W
	Max. 55m
	Rollo 40m

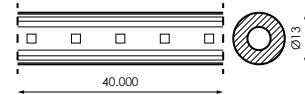

ESQUEMA INSTALACIÓN/  
INSTALLATION SCHEME/  
SCHEMA D'INSTALLATION/  
ESQUEMA DE INSTALAÇÃO



### Aviso/Warning/Avertissement/Aviso



**Ñ/** Los efectos de cambio de color solo funcionan con el controlador que es de **USO OBLIGATORIO**.

**E/** The color change effects only work with the controller that is **OBLIGATORY**.

**F/** Les effets de changement de couleur fonctionnent uniquement avec le contrôleur qui est **OBLIGATOIRE**.

**P/** Os efeitos de mudança de cor funcionam apenas com o controlador que é **USO OBRIGATORIO**.

### Accesorios/Accessories/Accessoires/Acessórios + INFO PAG. 238



**Ñ/** Adaptador **NO INCLUIDO**.

**E/** Adapter **NOT INCLUDED**.

**F/** Adaptateur **NON INCLUS**.

**P/** Adaptador **NÃO INCLUIDO**.

**547239**

Controlador RGB con mando a distancia **con adaptador INCLUIDO**

**486279**

Controlador RGB pasarela DMX sin adaptador

**454261**

Controlador RGB sincronización GPS sin adaptador

**192453**

Adaptador blanco SMART-FLEXILIGHT

**486262**

Controlador RGB sincronización Power line sin adaptador

**192477**

Adaptador negro SMART-FLEXILIGHT



# flexiLIGHT LED

## CW-WW

	230V dc
	CII
	IP65
	360°
	-20°C~+60 °C
	NO INC.
	NO INC.

Ñ/ EXTERIOR/TEXTURA LISA/TAPA FINAL INCLUIDA E/ OUTSIDE/SMOOTH TEXTURE/END COVER INCLUDED F/ À L'EXTERIEUR/TEXTURE LISSE/COUVERCLE INCLUS P/ EXTERIOR/TEXTURA LISA/TAMPA FINAL INCLUIDA

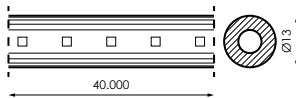
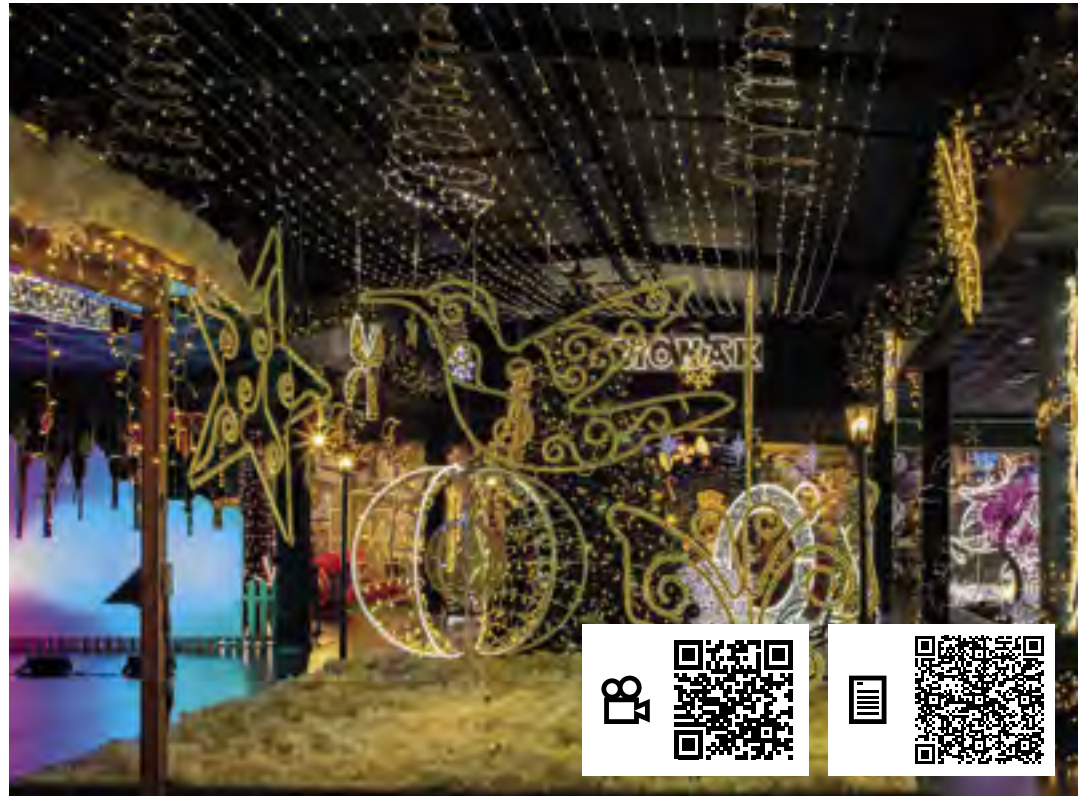

ESQUEMA INSTALACIÓN/  
INSTALLATION SCHEME/  
SCHEMA D'INSTALLATION/  
ESQUEMA DE INSTALAÇÃO



	1m
	13mm
	36
	4,6W
<b>W</b>	184W
	Max. 55m
	Rollo 40m

486347		

### Aviso/Warning/Avertissement/Aviso

Ñ/ Los efectos de cambio de color solo funcionan con el controlador que es de **USO OBLIGATORIO**.

E/ The color change effects only work with the controller that is **OBLIGATORY**.

F/ Les effets de changement de couleur fonctionnent uniquement avec le contrôleur qui est **OBLIGATOIRE**.

P/ Os efeitos de mudança de cor funcionam apenas com o controlador que é **USO OBRIGATÓRIO**.

### + INFO PAG. 238 **Accesorios/Accessories/Accessoires/Acessórios**

Ñ/ Adaptador **NO INCLUIDO**.

E/ Adapter **NOT INCLUDED**.

F/ Adaptateur **NON INCLUS**.

P/ Adaptador **NÃO INCLUIDO**.

**486309**  
Controlador CW-WW con mando a distancia sin adaptador

**486330**  
Controlador CW-WW pasarela DMX sin adaptador

**486316**  
Controlador CW-WW sincronización GPS sin adaptador

**192453**  
Adaptador blanco SMART-FLEXILIGHT

**486323**  
Controlador CW-WW sincronización Power line sin adaptador

**192477**  
Adaptador negro SMART-FLEXILIGHT

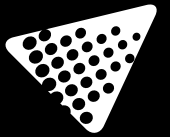

# Diseñamos tus Espacios

desde el proyecto  
hasta la realización

## Diseñamos tus Espacios

En el Departamento de Proyectos de Grupo Prilux realizamos proyectos de decoración, sin compromiso, donde se planifican y proyectan las mejores soluciones para cubrir espacios y elementos arquitectónicos, convirtiéndolos en ambientes donde vivir una auténtica experiencia lumínica.

## We design your Spaces

In the Prilux Group Projects Department we carry out decoration projects, without obligation, where the best solutions are planned and projected to cover spaces and architectural elements, turning them into environments where you can live an authentic lighting experience.

## Nous concevons vos espaces

Dans le département Projets du Groupe Prilux, nous réalisons des projets de décoration, sans engagement, où les meilleures solutions sont planifiées et projetées pour couvrir les espaces et les éléments architecturaux, en les transformant en environnements où vous pouvez vivre une expérience d'éclairage authentique.

## Nós projetamos seus espaços

No Departamento de Projetos do Grupo Prilux realizamos projetos de decoração, sem compromisso, onde as melhores soluções são planejadas e projetadas para cobrir espaços e elementos arquitetônicos, transformando-os em ambientes onde pode viver uma autêntica experiência de iluminação.

# STRING PLUS 100

## RGBWW

	230V dc
	CII
	1 CANAL
	IP65
	-20°C~+60 °C
	NO INC.



Nuevo  
New  
Nouveau  
Novo

SMART LINK



La Palma del Condado - Huelva

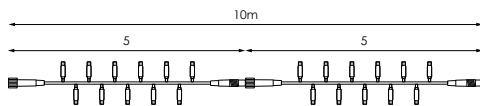

ESQUEMA INSTALACIÓN/  
INSTALLATION SCHEME/  
SCHEMA D'INSTALLATION/  
ESQUEMA DE INSTALAÇÃO



Producto/Product  
Produit/Produto

	10m (5m x 2seg)
	5m
	100
	50
	5,3W
	10,6W
	100m

514477		
514484		



### Aviso/Warning/Avertissement/Aviso

**Ñ**/ Los efectos de cambio de color solo funcionan con el controlador que es de **USO OBLIGATORIO** y con 10m de String Plus RGBWW.

**E**/ The color change effects only work with the controller that is **OBLIGATORY** and with 10m of String Plus RGBWW.

**F**/ Les effets de changement de couleur fonctionnent uniquement avec le contrôleur qui est **OBLIGATOIRE** et avec 10m de String Plus RGBWW.

**P**/ Os efeitos de mudança de cor funcionam apenas com o controlador que é **USO OBRIGATÓRIO** e com 10m de String Plus RGBWW.



+ INFO PAG. 238

### Accesorios/Accessories/Accessoires/Acessórios

**Ñ**/ Compatible con todos los accesorios **SMART LINK**

**E**/ Compatible with all **SMART LINK** accessories

**514514**

Controlador RGBWW con mando a distancia. Máx. 2.000leds

**566520**

Controlador RGBWW sincronización GPS. Máx. 100m/línea

**F**/ Compatible avec tous les accessoires **SMART LINK**

**P**/ Compatível com todos os acessórios **SMART LINK**

**514507**

Controlador RGBWW sincronización Power line. Máx. 2.000leds

**514491**

Controlador RGBWW pasarela DMX. Máx. 2.000leds

# STRING **PLUS** 100

RGB

SMART LINK 



Plaza Navarra -  
Huesca

 230V dc



 CII







 1 CANAL

 IP65

 -20°C~+60 °C

 NO INC.

		
549486		

	10m (5m x 2seg)
	5m
	100
	50
	4,6W
<b>W</b>	9,2W
	100m

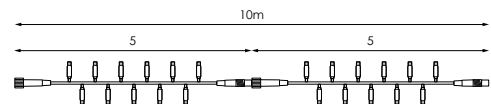

ESQUEMA INSTALACIÓN/  
INSTALLATION SCHEME/  
SCHEMA D'INSTALLATION/  
ESQUEMA DE INSTALAÇÃO



+

Producto/Product  
Produit/Produto

## Aviso/Warning/Avertissement/Aviso



**N**/ Los efectos de cambio de color solo funcionan con el controlador que es de **USO OBLIGATORIO** y con 10m de String Plus RGB.

**E**/ The color change effects only work with the controller that is **OBLIGATORY** and with 10m of String Plus RGB.

**F**/ Les effets de changement de couleur fonctionnent uniquement avec le contrôleur qui est **OBLIGATOIRE** et avec 10m de String Plus RGB.

**P**/ Os efeitos de mudança de cor funcionam apenas com o controlador que é **USO OBRIGATÓRIO** e com 10m de String Plus RGB.

## Accesorios/Accessories/Accessoires/Acessórios + INFO PAG. 238



**N**/ Compatible con todos los accesorios **SMART LINK**

**E**/ Compatible with all **SMART LINK** accessories

**F**/ Compatible avec tous les accessoires **SMART LINK**

**P**/ Compatível com todos os acessórios **SMART LINK**

**546683**

Controlador RGB con mando a distancia. Máx. 2.000leds

**486262**

Controlador RGB sincronización Power line. Máx. 2.000leds

**454261**

Controlador RGB sincronización GPS. Máx. 2.000leds







**486279**

Controlador RGB pasarela DMX. Máx. 2.000leds

# STRING **PLUS** 100

CW-WW

SMART  
LINK 

	230V dc
	CII
	1 CANAL
	IP65
	-20°C~+60 °C
	NO INC.





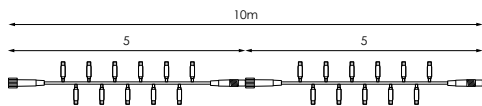



Galdar -  
Las Palmas









ESQUEMA INSTALACIÓN/  
INSTALLATION SCHEME/  
SCHEMA D'INSTALLATION/  
ESQUEMA DE INSTALAÇÃO



Producto/Product  
Produit/Produto

	10m (5m x 2seg)
	5m
	100
	50
	5,3W
	10,6W
	100m

		
486286		
486293		



## Aviso/Warning/Avertissement/Aviso

**N**/ Los efectos de cambio de color solo funcionan con el controlador que es de **USO OBLIGATORIO** y con 10m de String Plus CW/WW.

**E**/ The color change effects only work with the controller that is **OBLIGATORY** and with 10m of String Plus CW/WW.

**F**/ Les effets de changement de couleur fonctionnent uniquement avec le contrôleur qui est **OBLIGATOIRE** et avec 10m de String Plus CW/WW.

**P**/ Os efeitos de mudança de cor funcionam apenas com o controlador que é **USO OBRIGATÓRIO** e com 10m de String Plus CW/WW.



+ INFO PAG. 238

## Accesorios/Accessories/Accessoires/Acessórios

**N**/ Compatible con todos los accesorios **SMART LINK**

**E**/ Compatible with all **SMART LINK** accessories

**F**/ Compatible avec tous les accessoires **SMART LINK**

**P**/ Compatível com todos os acessórios **SMART LINK**

**486309**

Controlador CW-WW con mando a distancia. Máx. 2.000leds

**486323**

Controlador CW-WW sincronización Power line. Máx. 2.000leds

**486316**

Controlador CW-WW sincronización GPS. Máx. 2.000leds

**486330**

Controlador CW-WW pasarela DMX. Máx. 2.000leds

# SCREENLIGHT 400

RGB

SMART LINK 

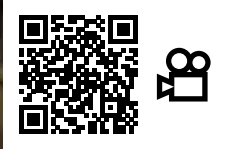

Escatrón - Zaragoza

 230V dc

 CII

 1 CANAL





 IP65

 -20°C~+60 °C

 NO INC.



546652

	2x2m
	20 (2 filas = 1 serie)
	400
	20
<b>W</b>	46W
	5sets

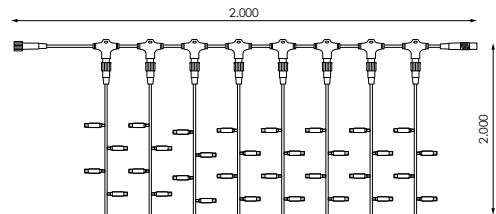

ESQUEMA INSTALACIÓN/  
INSTALLATION SCHEME/  
SCHEMA D'INSTALLATION/  
ESQUEMA DE INSTALAÇÃO



+

Producto/Product  
Produit/Produto

## Aviso/Warning/Avertissement/Aviso

**N**/Los efectos de cambio de color solo funcionan con el controlador que es de **USO OBLIGATORIO**.

**E**/ The color change effects only work with the controller that is **OBLIGATORY**.

**F**/ Les effets de changement de couleur fonctionnent uniquement avec le contrôleur qui est **OBLIGATOIRE**.

**P**/ Os efeitos de mudança de cor funcionam apenas com o controlador que é **USO OBRIGATORIO**.

## Accesorios/Accessories/Accessoires/Acessórios + INFO PAG. 238

**N**/Compatible con todos los accesorios **SMART LINK**

**E**/ Compatible with all **SMART LINK** accessories

**F**/ Compatible avec tous les accessoires **SMART LINK**

**P**/ Compatível com todos os acessórios **SMART LINK**

**546683**

Controlador RGB con mando a distancia. Máx. 2.000leds

**486262**

Controlador RGB sincronización Power line. Máx. 2.000leds

**454261**

Controlador RGB sincronización GPS. Máx. 2.000leds

**486279**

Controlador RGB pasarela DMX. Máx. 2.000leds

# ICICLE 174

## RGB

	230V dc
	CII
	1 CANAL
	IP65
	-20°C~+60 °C
	NO INC.

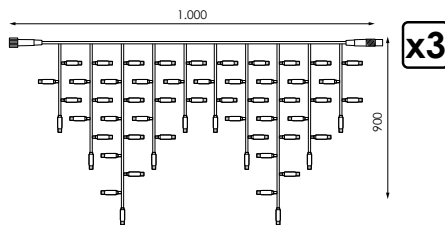
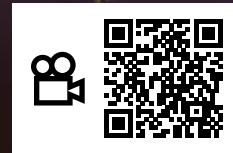

ESQUEMA INSTALACIÓN/  
INSTALLATION SCHEME/  
SCHEMA D'INSTALLATION/  
ESQUEMA DE INSTALAÇÃO



+

Producto/Product  
Produit/Produto

	3x0,9m (1m x 3seg)
	3
	174
	58
	13,8W
	11sets

546669		



### Aviso/Warning/Avertissement/Aviso

**Ñ**/ Los efectos de cambio de color solo funcionan con el controlador que es de **USO OBLIGATORIO**.

**E**/ The color change effects only work with the controller that is **OBLIGATORY**.

**F**/ Les effets de changement de couleur fonctionnent uniquement avec le contrôleur qui est **OBLIGATOIRE**.

**P**/ Os efeitos de mudança de cor funcionam apenas com o controlador que é **USO OBRIGATÓRIO**.



+ INFO PAG. 238

### Accesorios/Accessories/Accessoires/Acessórios

**Ñ**/ Compatible con todos los accesorios **SMART LINK**

**E**/ Compatible with all **SMART LINK** accessories

**F**/ Compatible avec tous les accessoires **SMART LINK**

**P**/ Compatível com todos os acessórios **SMART LINK**

**546683**

Controlador RGB con mando a distancia. Máx. 2.000leds

**486262**

Controlador RGB sincronización Power line. Máx. 2.000leds

**454261**

Controlador RGB sincronización GPS. Máx. 2.000leds

**486279**

Controlador RGB pasarela DMX. Máx. 2.000leds

# CONTROLADORES

## RGBWW/RGB/CW-WWW

### CONTROLADOR

Sincronización con mando a distancia

514514 - RGBWW  
546683/547239 - RGB  
486309 - CW/WW



Máx. 2.000leds

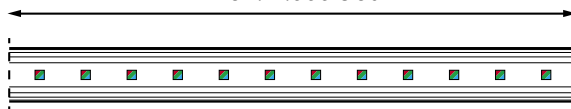

### CONTROLADOR

Sincronización mediante satélite GPS.  
Cambio secuencial cada 15segundos.  
SOLO uso exterior.

566520 - RGBWW  
454261 - RGB  
486316 - CW/WW

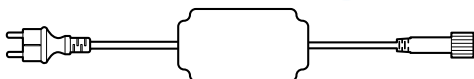

Máx. 2.000leds

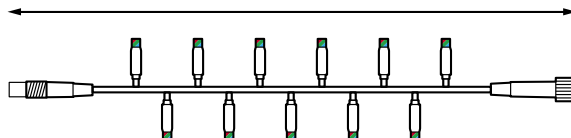

### CONTROLADOR

Sincronización con línea eléctrica.  
Cambio secuencial cada 15segundos

514507 - RGBWW  
486262 - RGB  
486323 - CW/WW

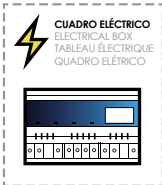

Máx. 2.000leds

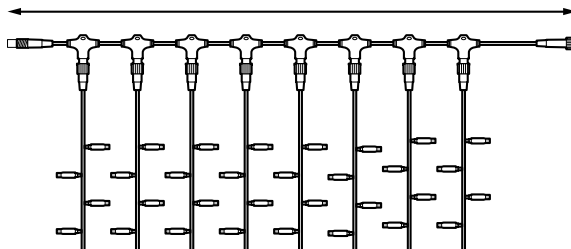

### CONTROLADOR/PASARELA DMX

Stand-Alone  
Cambio secuencial cada 15segundos  
si no recibe señal DMX

514491 - RGBWW  
486279 - RGB  
486330 - CW/WW

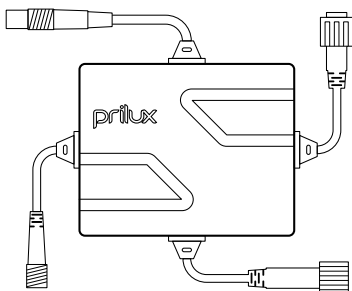

Máx. 2.000leds

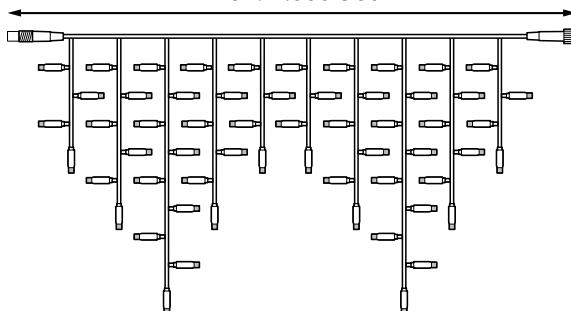



# CONTROLADORES

486279/486330

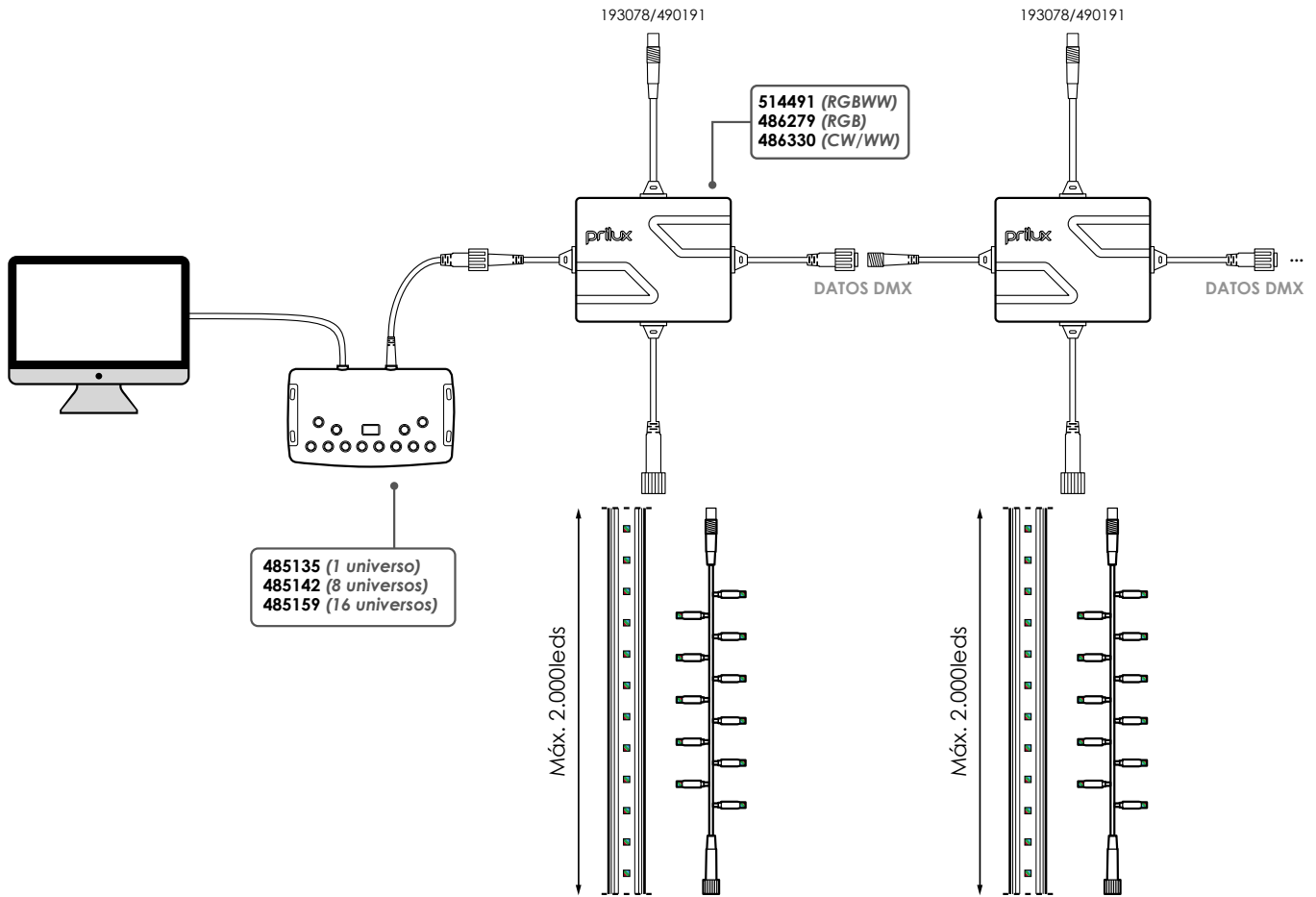

CÓDIGO CONTROLADOR DMX	UNIVERSOS	MÁX. CONTROLADORES A EMPALMAR
485135	1 universo	512 controladores
485142	8 universos	4.096 controladores
485159	16 universos	8.192 controladores



+ INFO PAG. 238

## Accesorios/Accessories/Accessoires/Acessórios

**Ñ/** Accesorios y cable de alimentación **NO INCLUIDOS** para utilizar entre pasarelas si hay distancia entre ellas.

**E/** Accessories and power cable **NOT INCLUDED** to be used between walkways if there is distance between them.

**F/** Accessoires et câble d'alimentation **NON INCLUS** à utiliser entre passerelles s'il existe une distance suffisante entre elles.

**P/** Acessórios e cabo de alimentação **NÃO INCLUIDO** para ser usado entre passarelas se houver distância entre eles.

Icono	Descripción
	490207 Extensión DMX 1m
	490214 Extensión DMX 3m
	490221 Extensión DMX 5m
	490245 Direccionador caja DMX
	193078 Cable alimentación con shuko 1,5m
	490191 Cable alimentación sin shuko 1m

# STRING **PLUS** 100 24V

RGB/CW-WWW



	24V dc
	CIII
	1 CANAL
	IP44
	-20°C~+60 °C
	NO INC.
	NO INC.
	NO INC.

486385		
486378		

	<b>10m</b> (5m x 2seg)
	<b>5m</b>
	<b>100</b>
	<b>50</b>
	<b>3,6W</b>
	<b>7,2W</b>
	<b>40m</b>

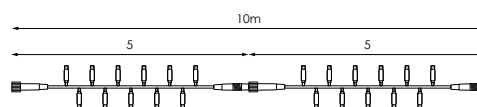

ESQUEMA INSTALACIÓN/  
INSTALLATION SCHEME/  
SCHEMA D'INSTALLATION/  
ESQUEMA DE INSTALAÇÃO



# STRING **PLUS** 100 24V

RGB/CW-WW

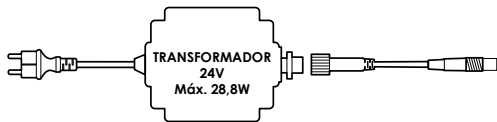

## CONTROLADOR

sincronización con mando

486392 - RGB  
486422 - CW/WW



## CONTROLADOR

sincronización con cuadro eléctrico

486408 - RGB  
486439 - CW/WW

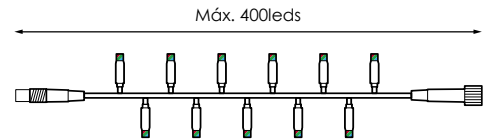
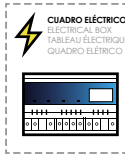

**Aviso/Warning/Avertissement/Aviso**

**Ñ**/ Los efectos de cambio de color solo funcionan con el controlador que es de **USO OBLIGATORIO**.

**E**/ The color change effects only work with the controller that is **OBLIGATORY**.

**F**/ Les effets de changement de couleur fonctionnent uniquement avec le contrôleur qui est **OBLIGATOIRE**.

**P**/ Os efeitos de mudança de cor funcionam apenas com o controlador que é **USO OBRIGATÓRIO**.



+ INFO PAG. 238 **Accesorios/Accessories/Accessoires/Acessórios**

**Ñ**/ Compatible con todos los accesorios **24V**

**E**/ Compatible with all **24V** accessories

**F**/ Compatible avec tous les accessoires **24V**

**P**/ Compatível com todos os acessórios **24V**

**486392**

Controlador RGB con mando a distancia. Máx. 400leds

**486439**

Controlador CW-WW sincronización Power line. Máx. 400leds

**486408**

Controlador RGB sincronización Power line. Máx. 400leds

**149181**

Transformador 10,8W

**486422**

Controlador CW-WW con mando a distancia. Máx. 400leds

**149198**

Transformador 28,8W

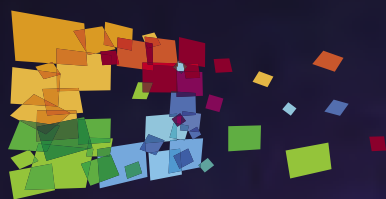

# PIXELMAX

## Control pixel a pixel

---

Con la gama de productos Pixelmax es posible ofrecer efectos dinámicos realmente diferenciadores. Gracias a la tecnología Pixelmax disponemos de control individual de cada LED, tanto de color como de flujo emitido, desde un puesto de control centralizado lo que permite que convirtamos nuestra instalación en una pantalla de efectos de luz a medida. Con nuestra gama de controladores es posible cubrir las necesidades que exija cada proyecto, desde efectos dinámicos en pequeños motivos hasta convertir la fachada de un edificio en una pantalla RGB/RGBW sobre la que reproducir vídeos.

### Pixel to pixel control

---

With the Pixelmax product range it is possible to offer truly differentiating dynamic effects. Thanks to Pixelmax technology we have individual control of each LED, both color and flow emitted, from a centralized control post, which allows us to turn our installation into a custom light effects screen. With our range of controllers it is possible to meet the needs of each project, from dynamic effects in small motifs to converting the facade of a building into an RGB/RGBW screen on which to play videos.

### Contrôle pixel à pixel

---

La gamme de produits Pixelmax permet d'offrir des effets dynamiques véritablement différenciants. Grâce à la technologie Pixelmax, nous avons un contrôle individuel de chaque LED, à la fois en couleur et en flux émis, depuis un poste de contrôle centralisé, ce qui nous permet de transformer notre installation en un écran à effets de lumière personnalisé. Avec notre gamme de contrôleurs, il est possible de répondre aux besoins de chaque projet, des effets dynamiques dans les petits motifs à la conversion de la façade d'un bâtiment en un écran RGB/RGBW sur lequel lire des vidéos.

### Controle de pixel para pixel

---

Com a gama de produtos Pixelmax, é possível oferecer efeitos dinâmicos verdadeiramente diferenciadores. Graças à tecnologia Pixelmax, temos um controle individual de cada LED, tanto em cores quanto em fluxo, a partir de um posto de controle centralizado, o que nos permite transformar nossa instalação em uma tela de efeitos de luz personalizada. Com a nossa gama de controladores, é possível atender às necessidades de cada projeto, desde efeitos dinâmicos em pequenos motivos até a conversão da fachada de um edifício em uma tela RGB/RGBW na qual reproduzir vídeos.

[GRÁFICOS: Unidades en mm/ GRÁFICOS: Units in mm/ GRAPHIQUES: Unités en mm/ GRÁFICOS: Unidades em mm]



# STRING PIXELMAX RGB

12V



12V dc

CIII

IP65

NO INC.

484275		

	2m
	20
	12W
	SEGÚN CONTROLADOR

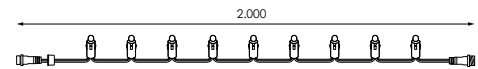

484268		

	5m
	50
	30W
	SEGÚN CONTROLADOR

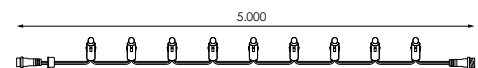

## Accesorios/Accessories/Accessoires/Acessórios + INFO PAG. 238



<b>472494</b> Controlador DMX-SPI 1 salida
<b>484282</b> Fuente alimentación 60W 12V IP66
<b>484299</b> Conector T SPI (2 entradas/1 salida)
<b>484312</b> Extensión 25cm SPI
<b>518161</b> Extensión 5m SPI

<b>485173</b> Controlador Master SPI 4 salidas
<b>563161</b> Fuente alimentación 250W 12V IP66
<b>484343</b> Conector T SPI (1 entrada/2 salidas)
<b>518154</b> Extensión 50cm SPI
<b>518178</b> Extensión 10m SPI

<b>485180</b> Controlador Master SPI 8 salidas
<b>485166</b> Amplificador señal DMX 3 salidas
<b>484350</b> Conector 3 SPI (1 entrada/4 salidas)
<b>484329</b> Extensión 1m SPI

<b>485159</b> Controlador Master DMX512-SPI 16 salidas
<b>484305</b> Conector a fuente alimentación
<b>484367</b> Conector 5 SPI (1 entrada/6 salidas)
<b>484336</b> Extensión 3m SPI

# CONEXIÓN EN SERIE

## ESQUEMA INSTALACIÓN 1 SALIDA

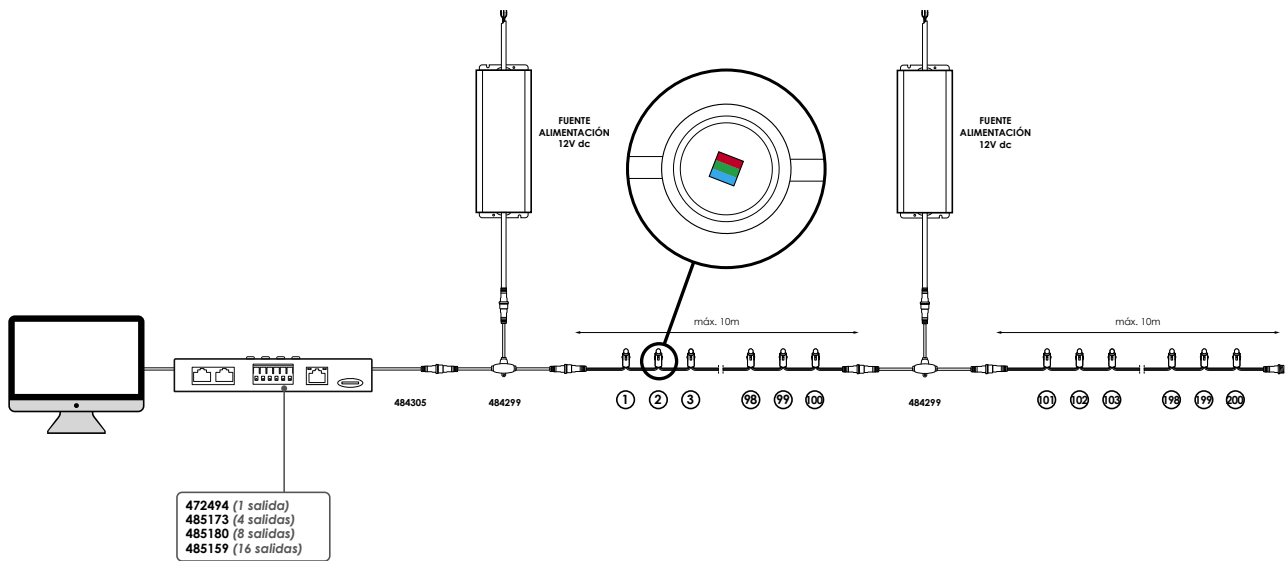

# CONEXIÓN EN PARALELO

## ESQUEMA INSTALACIÓN 1 SALIDA

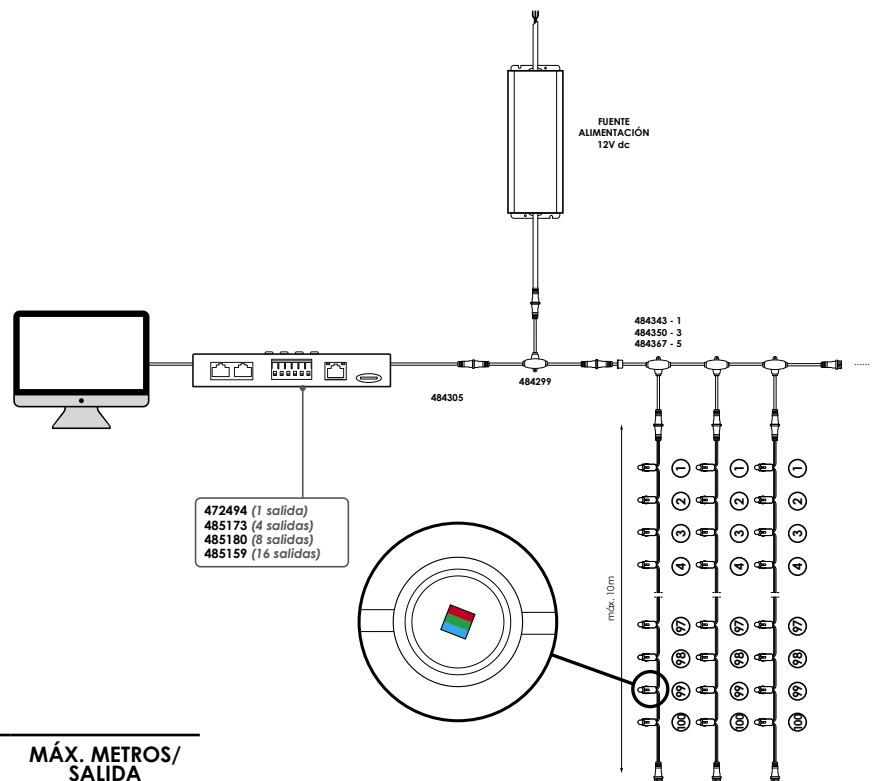

CÓDIGO CONTROLADOR	Nº SALIDAS	MÁX. PÍXELES	MÁX. METROS/SALIDA
<b>472494</b>	1 salida	170 píxeles	17m
<b>485173</b>	4 salidas	680 píxeles	17m
<b>485180</b>	4x2 salidas	1.360 píxeles	34m
<b>485159</b>	16 salidas	21.760 píxeles	136m

# DOT DMX PIXELMAX RGBW

24V



24V dc

CIII

IP65

NO INC.

484886		

	1m
	10
<b>W</b>	20W
	SEGÚN CONTROLADOR

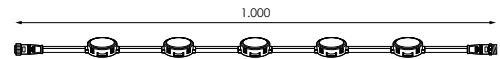

484879		

	5m
	50
<b>W</b>	92W
	SEGÚN CONTROLADOR

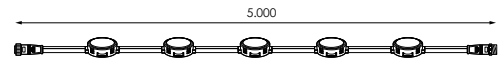

## Accesorios/Accessories/Accessoires/Acessórios + INFO PAG. 238



<b>485135</b>
Controlador Master DMX512 1 universo
<b>488464</b>
Fuente alimentación 100W 24V
<b>484916</b>
Conector T DMX (2 entradas/1 salida)
<b>484923</b>
Extensión 25cm DMX

<b>485142</b>
Controlador Master DMX512 8 universos
<b>481687</b>
Fuente alimentación 150W 24V
<b>484954</b>
Conector T DMX (1 entrada/2 salidas)
<b>484930</b>
Extensión 1m DMX

<b>485159</b>
Controlador Master DMX512 16 universos
<b>481694</b>
Fuente alimentación 200W 24V
<b>484961</b>
Conector 3 DMX (1 entrada/4 salidas)
<b>484947</b>
Extensión 3m DMX

<b>488457</b>
Fuente alimentación 60W 24V
<b>485197</b>
Conector a fuente alimentación
<b>484978</b>
Conector 5 DMX (1 entrada/6 salidas)
<b>485166</b>
Amplificador señal DMX 3 salidas



# CONEXIÓN EN SERIE

## ESQUEMA INSTALACIÓN 1 UNIVERSO

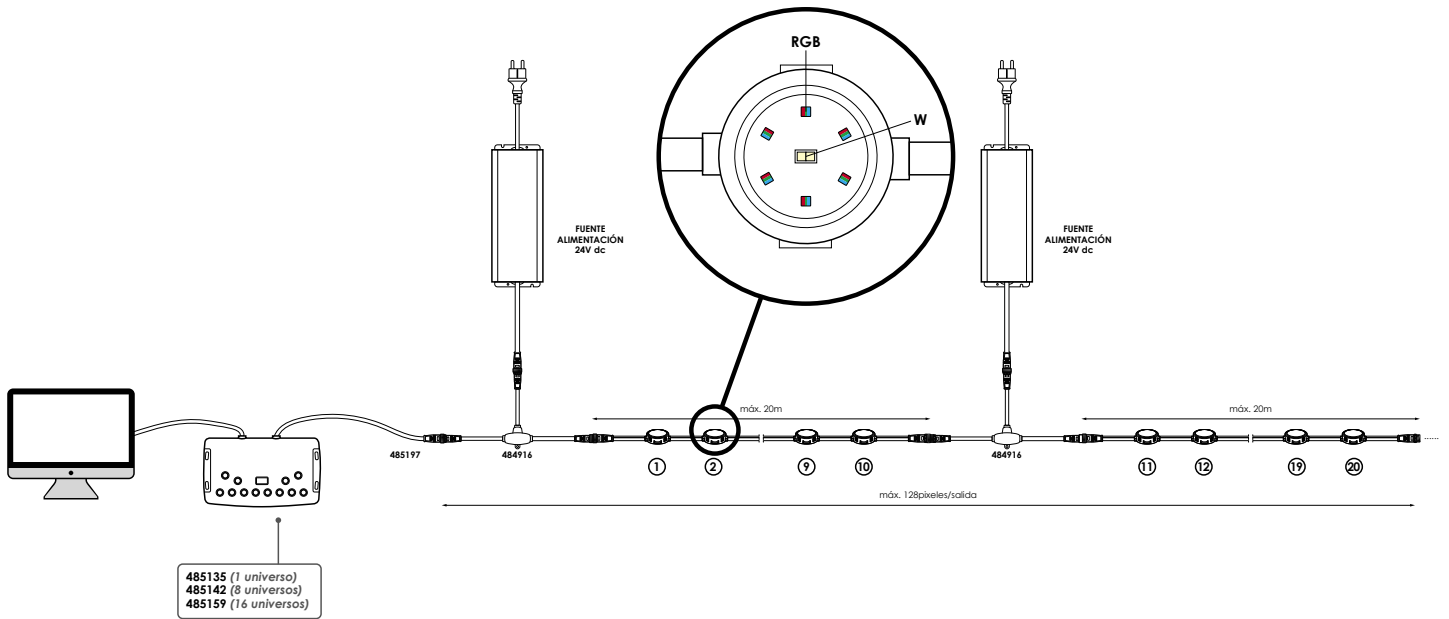

# CONEXIÓN EN PARALELO

## ESQUEMA INSTALACIÓN 1 UNIVERSO

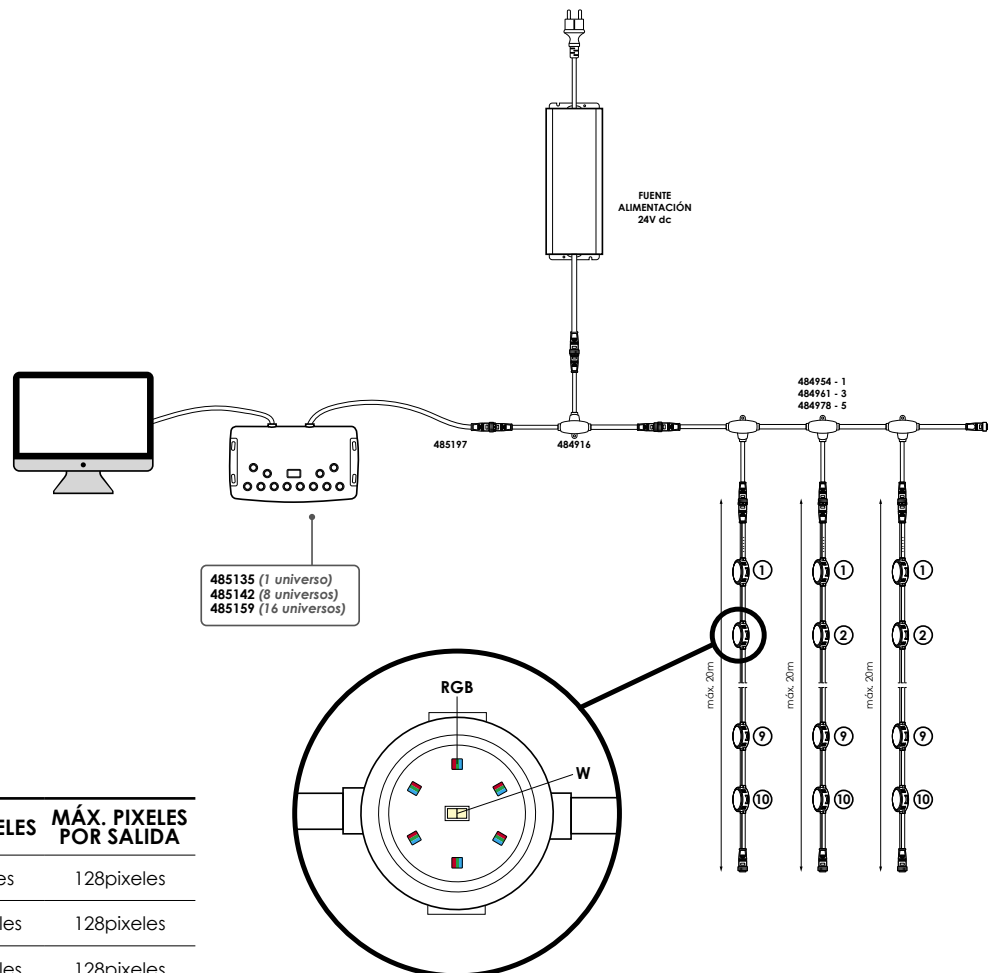

CÓDIGO CONTROLADOR	UNIVERSOS/SALIDAS	MÁX. PÍXELES	MÁX. PÍXELES POR SALIDA
485135	1 universo	128píxeles	128píxeles
485142	8 universos	1.024píxeles	128píxeles
485159	16 universos	2.048píxeles	128píxeles

# SCREEN PIXELMAX RGB

4x2m

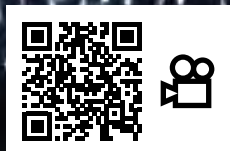
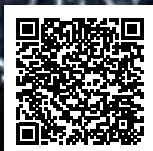
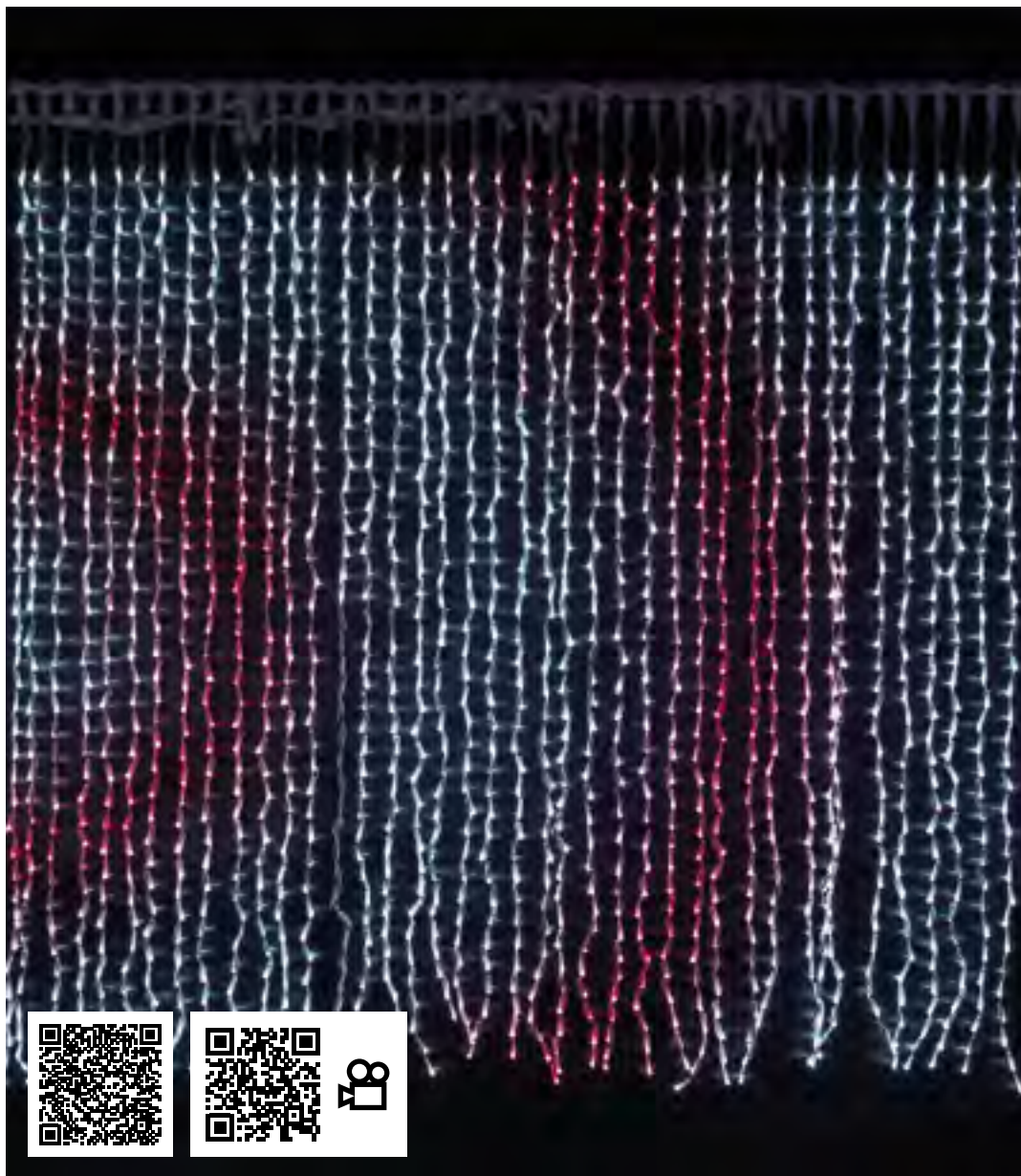

	66V dc
	CII
	IP44
	x8 PF-BOX
	Controlador esclavo
	Controlador master

Ñ/ Cables de alimentación y caja estanca **INCLUIDOS** E/ Power cables and waterproof case **INCLUDED** F/ Câbles d'alimentation et boîtier étanche **INCLUS** P/ Cabos de alimentação e caixa à prova d'água **INCLUIDO**

496780		

	4x2m
	80
	3200
	40
<b>W</b>	528W

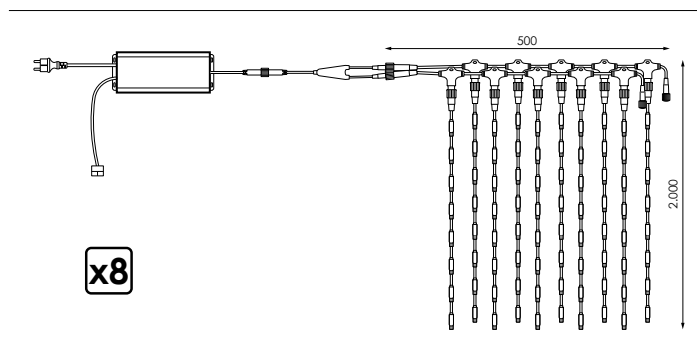

## Información/Information/Information/Informações



Ñ/ Se sirve con animación standard preprogramada.

E/ It is served with pre-programmed standard animation.

F/ Il est servi avec une animation standard préprogrammée.

P/ É servido com animação padrão pré-programada.

# INSTALACIÓN SCREEN PIXELMAX

Conexión de un tramo 0,5m y PF BOX a controlador esclavo

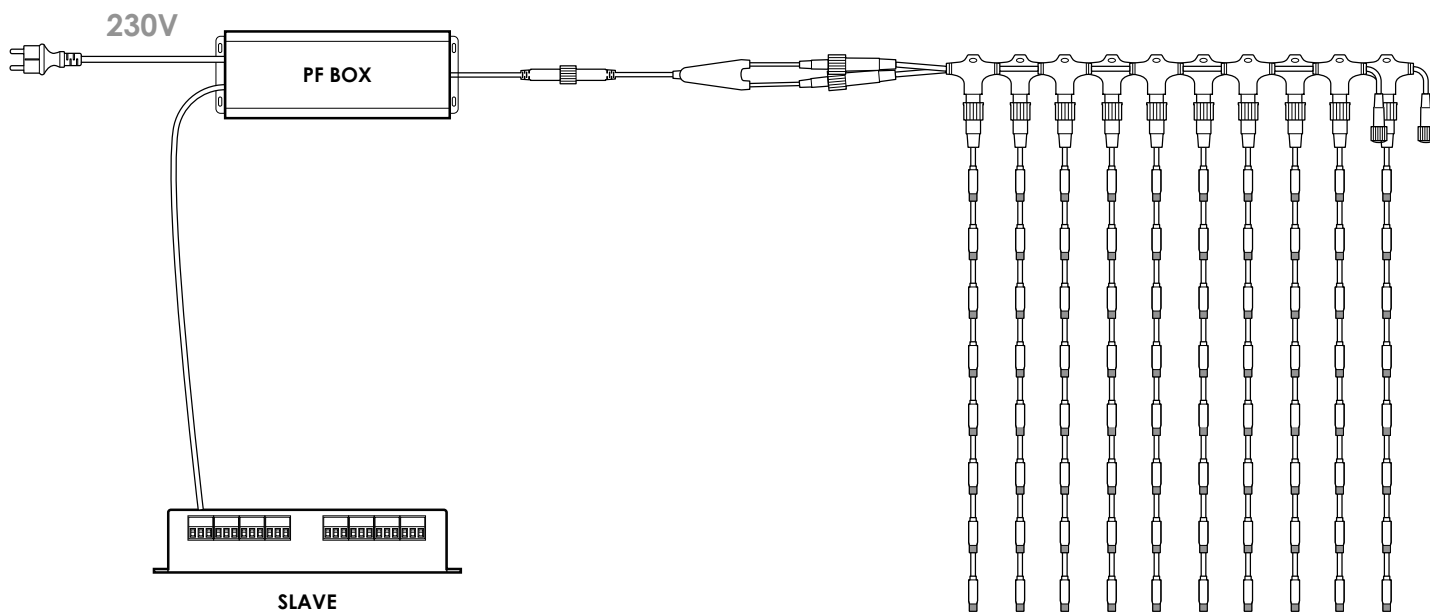

Tramo 4x2m

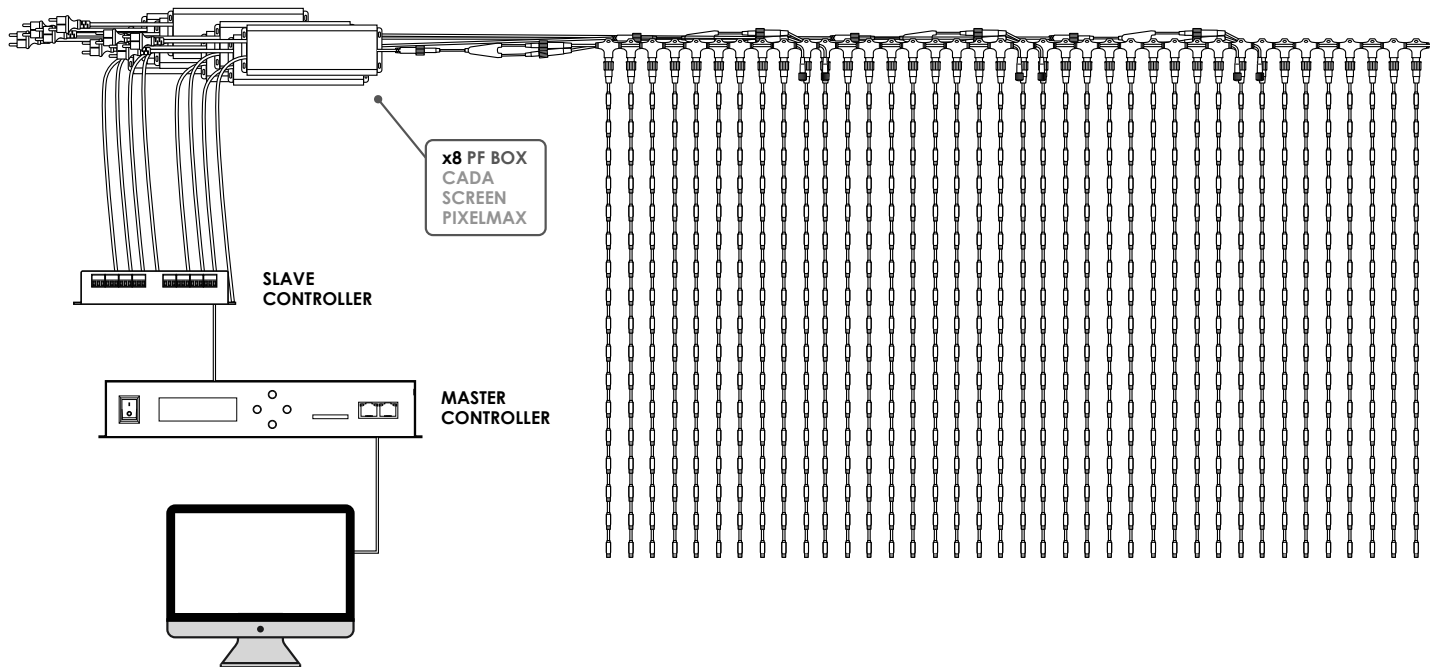

Aviso/Warning/Avertissement/Aviso

Ñ/ Esquema de instalación para Screen PIXELMAX de 4x2m (incluye controlador master y controlador esclavo). **Para ampliación de dimensiones (8x2m, 4x4m,...), consultar bajo pedido con el departamento de sistemas de control.**

E/ Installation diagram for Screen PIXELMAX 4x2m (includes master controller and slave controller). **To enlarge the dimensions (8x2m, 4x4m, ...), check on request with the control systems department.**

F/ Écran de veille pour écran PIXELMAX de 4x2m (comprend le contrôleur maître et le contrôleur esclave). **Para ampliación de dimensiones (8x2m, 4x4m, ...), vérifiez sur demande auprès du service des systèmes de contrôle.**

P/ Esquema de instalação para tela PIXELMAX de 4x2m (inclui controlador mestre e controlador esclavo). **Para ampliação de dimensões (8x2m, 4x4m, ...), verifique a pedido com o departamento de sistemas de controle.**

# MESH PIXELMAX RGBW

**N** Nuevo  
New  
Nouveau  
Novo

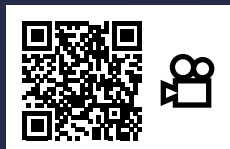

24V dc

CIII

IP65

NO INC.



566896



	80x160cm
	8
	128
	16
<b>W</b>	192W

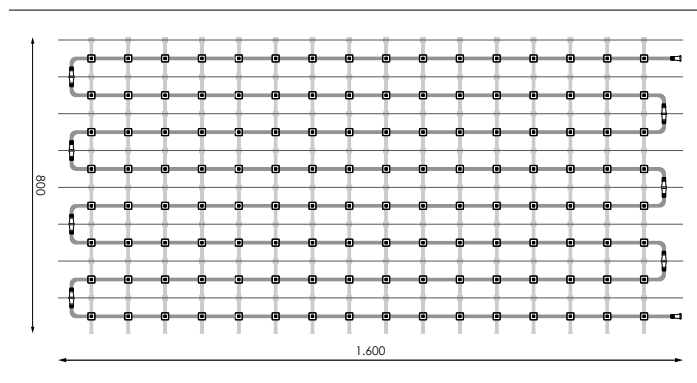

## Accesorios/Accessories/Accessoires/Accessórios + INFO PAG. 238



<b>485173</b> Controlador Master SPI 4 salidas/4 universos	<b>485180</b> Controlador Master SPI 4x2 salidas/8 universos	<b>568968</b> Controlador Slave SPI 8 salidas/8 universos	<b>567992</b> Conector T DMX (2 entradas/1 salida)
<b>481694</b> Fuente alimentación 200W 24V	<b>568982</b> Conector a controlador	<b>569996</b> Cierre M4 para cable de acero	<b>569989</b> Tensor para cable de acero
<b>570350</b> Extensión 1m DMX	<b>570367</b> Extensión 3m DMX	<b>570374</b> Extensión 5m DMX	<b>570381</b> Extensión 10m DMX

## Información/Information/Information/Informações



**N/** Se sirve con animación standard preprogramada.

**E/** It is served with pre-programmed standard animation.

**F/** Il est servi avec une animation standard préprogrammée.

**P/** É servido com animação padrão pré-programada.

# INSTALACIÓN MESH PIXELMAX

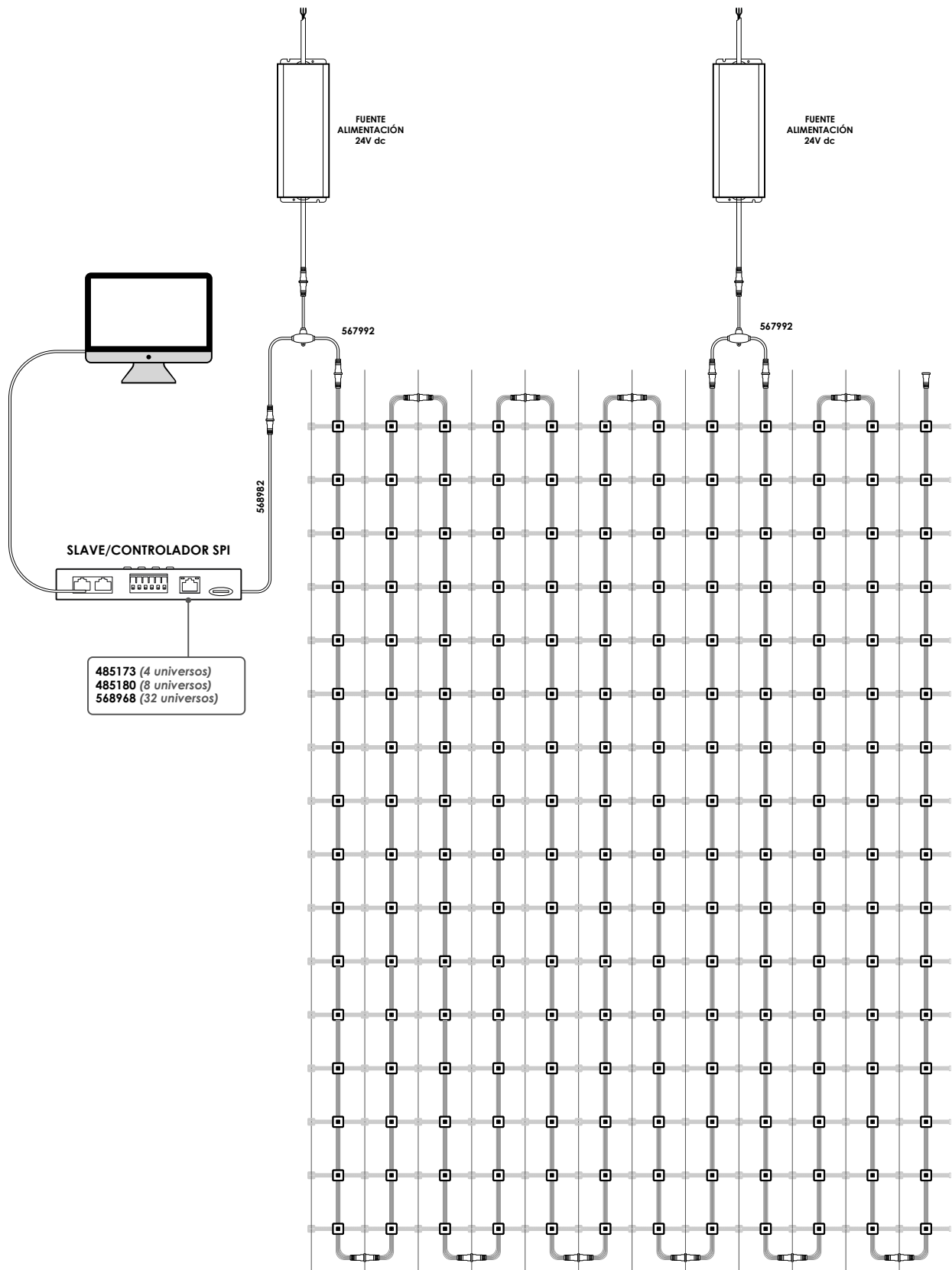

**Aviso/Warning/Avertissement/Aviso**

Ñ/ Esquema de instalación para Mesh PIXELMAX. **Para ampliación de dimensiones, consultar bajo pedido con el departamento de sistemas de control.**

E/ Installation diagram for Mesh PIXELMAX. **To enlarge the dimensions, check on request with the control systems department.**

F/ Écran de veille pour Mesh PIXELMAX. **Para ampliación de dimensiones, vérifiez sur demande auprès du service des systèmes de contrôle.**

P/ Esquema de instalação para Mesh PIXELMAX. **Para ampliação de dimensões, verifique a pedido com o departamento de sistemas de controle.**

# CONTROLADOR

para productos estáticos

Una manera sencilla de añadir dinamismo a todos nuestros productos estáticos (230V) y crear espacios divertidos y con movimiento.

## CONTROLLER

for static products

A simple way to add dynamism to all our static products (230V) and create fun and moving spaces.

## CONTRÔLEUR

pour les produits statiques

Un moyen simple d'ajouter du dynamisme à tous nos produits statiques (230V) et de créer des espaces amusants et émouvants.

## CONTROLADOR

para produtos estáticos

Uma maneira simples de adicionar dinamismo a todos os nossos produtos estáticos (230V) e criar espaços divertidos e móveis.

## CONTROLADOR

2 canales DMX-TRIAC

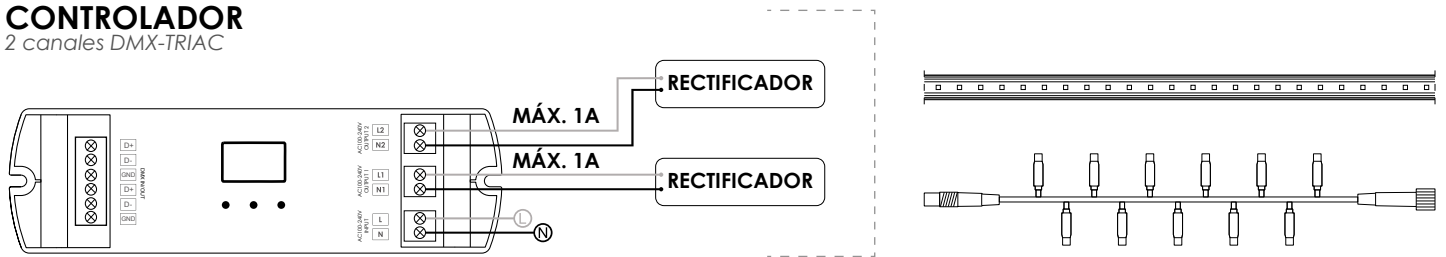

## Accesorios/Accessories/Accessoires/Acessórios + INFO PAG. 238



<b>451154</b> Controlador DMX triac (2 canales)	<b>485135</b> Controlador Master DMX512 1 universo	<b>485142</b> Controlador Master DMX512 8 universos	<b>485159</b> Controlador Master DMX512-SPI 16 universos
<b>490641</b> Box control 2 salidas	<b>490658</b> Box control 6 salidas	<b>490665</b> Box control 10 salidas	<b>485166</b> Amplificador señal DMX
<b>N 496902</b> Caja estanca controlador DMX	<b>N 493338</b> Fuente alimentación 12V 15W		

## Aviso/Warning/Avertissement/Aviso



**N/** Estos productos son IP20 (excepto los box de control) y para instalaciones en exterior es necesaria una caja estanca.

**E/** These products are IP20 (except the control boxes) and for outdoor installations a watertight box is necessary.

**F/** Ces produits sont IP20 (sauf pour les boîtiers de commande) et pour les installations extérieures, un boîtier étanche est requis.

**P/** Esses produtos são IP20 (exceto para caixas de controle) e para instalações externas é necessária uma caixa estanca.



**MOTIVO**



**Calle Alfonso I -  
ZARAGOZA**





**CALLE**

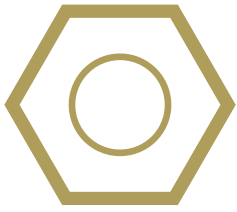







# Accesorios

Accessories  
Accessoires  
Acessórios

		flexLIGHT RGB	flexLIGHT CW-WW	STRING PLUS 100 RGBWW	STRING PLUS 100 RGB	STRING PLUS 100 CW-WW	SCREENLIGHT RGB	ICICLE RGB	STRING PLUS 100 RGB 24V	STRING PLUS 100 CW-WW 24V	STRING PIXELMAX	DOT DMX PIXELMAX	SCREEN PIXELMAX	MESH PIXELMAX	PRODUCTOS ESTÁTICOS 230V	PASARELA 486279/486330	
	149181								•	•							
	149198								•	•							
	193061															•	
	193078															•	
	481687											•					
	481694											•		•			
	484282											•					
	488457											•					
	488464											•					
	493338														•		
	563161											•					
	451154														•		
	454261	•			•												
	472494										•						
	485135					•			•			•					
	485142					•			•			•					
	485159										•						
	485166					•			•	•	•	•					
	485173										•			•			
	485180										•			•			
	486262	•			•												
	486279	•			•												
	486309		•			•											
	486316		•			•											
	486323		•			•											
	486330		•			•											
	486392								•								
	486408								•								
	486422									•							
	486439									•							
	486460													•			
	490191																•
	490245																•
	490641															•	
	490658															•	
	490665															•	
	496445											•					
	496902	•	•													•	
	514491			•													
	514507			•													
	514514			•													
	519236											•					



		flexLIGHT RGB	flexLIGHT CW-WW	STRING PLUS 100 RGBWW	STRING PLUS 100 RGB	STRING PLUS 100 CW-WW	SCREENLIGHT RGB	ICICLE RGB	STRING PLUS 100 RGB 24V	STRING PLUS 100 CW-WW 24V	STRING PIXELMAX	DOT DMX PIXELMAX	SCREEN PIXELMAX	MESH PIXELMAX	PRODUCTOS ESTÁTICOS 230V	PASARELA 486279/486330
	546683				•		•	•								
	547239	•														
	566520			•												
	567992													•		
	568562										•					
	192323				•	•	•	•								
	192347				•	•	•	•								
	192354				•	•	•	•								
	192361				•	•	•	•								
	192378				•	•	•	•								
	192385				•	•	•	•								
	192392				•	•	•	•								
	192408				•	•	•	•								
	192415				•	•	•	•								
	192422				•	•	•	•								
	192439				•	•	•	•								
	192446				•	•	•	•								
	192453	•	•		•	•	•	•	•							
	192477	•	•		•	•	•	•	•							
	192484	•	•		•	•	•	•	•							
	192491	•	•		•	•	•	•	•							
	388368				•	•	•	•	•							
	388375				•	•	•	•	•							
	388382				•	•	•	•	•							
	388399				•	•	•	•	•							
	388498				•	•	•	•	•							
	388504				•	•	•	•	•							
	391498				•	•	•	•	•							
	391504				•	•	•	•	•							
	391535									•						
	481700									•						
	481717									•						
	481724									•						
	484299										•					
	484305										•					
	484312										•					
	484312										•					
	484329										•					
	484336										•					
	484343										•					
484350										•						
484367										•						
484916											•					
484923											•					
484930											•					
484947											•					
484954											•					
484961											•					
484978											•					
485197											•		•			

		flexiLIGHT RGB	flexiLIGHT CW-WW	STRING PLUS 100 RGBWW	STRING PLUS 100 RGB	STRING PLUS 100 CW-WW	SCREENLIGHT RGB	ICICLE# RGB	STRING PLUS 100 RGB 24V	STRING PLUS 100 CW-WW 24V	STRING PIXELMAX	DOT DMX PIXELMAX	SCREEN PIXELMAX	MESH PIXELMAX	PRODUCTOS ESTÁTICOS 230V	PASARELA 486279/486330
490207																•
490214																•
490221																•
490740						•			•	•	•	•	•			
496735											•					
518154											•					
518161											•					
518178											•					
 551779						•			•	•	•	•				
567992																
569989														•		
569996														•		
971140									•							
971188									•							
971195									•							
971201									•							
971218									•							

### CONTROLADOR RGBWW CON MANDO

STRING PLUS

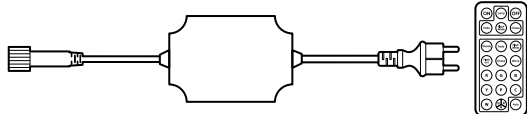

514514



230V



IP55

W

Max. 2.000leds

Efecto memoria  
Memory effect  
Effet mémoire  
Efeito de memória

### CONTROLADOR/PASARELA DMX RGBWW

STRING PLUS

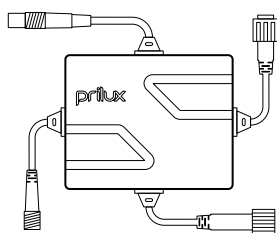

514491



230V



IP55

W

Max. 2.000leds

Cambio secuencial cada 15seg. si no recibe señal DMX.  
Sequential change every 15sec. if you do not receive DMX signal.  
Changement séquentiel toutes les 15 secondes. si vous ne recevez pas de signal DMX.  
Mudança sequencial a cada 15 seg. se você não receber sinal DMX.

### CONTROLADOR POWER LINE RGBWW

STRING PLUS

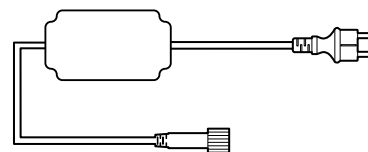

514507



230V



IP55

W

Max. 2.000leds

Sincronización coordinada mediante una línea eléctrica. Cambio secuencial cada 15seg.  
Coordinated synchronization through an electrical panel. Sequential change every 15sec.  
Synchronisation coordonnée via un tableau électrique. Changement séquentiel toutes les 15s.  
Sincronização coordenada através de um painel elétrico. Mudança sequencial a cada 15seg.

### SINCRONIZADOR GPS RGBWW

STRING PLUS

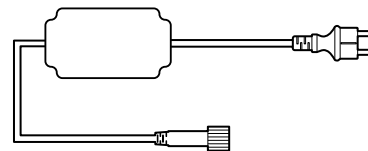

566520



230V



IP55

W

Max. 100m/línea

Sincronización mediante satélite GPS. Solo uso exterior. Cambio secuencial cada 15seg.  
GPS satellite synchronization. Only outside use. Sequential change every 15sec.  
Synchronisation satellite GPS. Seulement utilisation à l'extérieur. Changement séquentiel toutes les 15s.  
Sincronização por satélite GPS. Apenas fora de uso. Mudança sequencial a cada 15seg.

### CONTROLADOR RGB CON MANDO

FLEXILIGHT

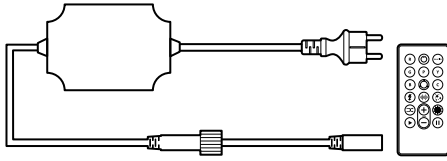

547239



230V



IP55



Max. 2.000leds

Efecto memoria  
Memory effect  
Effet mémoire  
Efeito de memória

### CONTROLADOR RGB CON MANDO

STRING PLUS-SCREENLIGHT-ICICLE

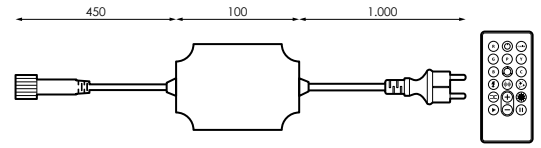

546683



230V



IP55



Max. 2.000leds

Efecto memoria  
Memory effect  
Effet mémoire  
Efeito de memória

### CONTROLADOR POWER LINE RGB

FLEXILIGHT-STRING PLUS-SCREENLIGHT-ICICLE

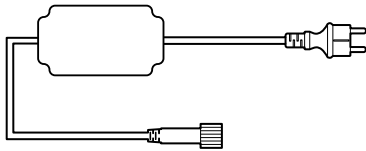

486262



230V



IP55



Max. 2.000leds

Sincronización coordinada mediante una línea eléctrica. Cambio secuencial cada 15seg.  
Coordinated synchronization through an electrical panel. Sequential change every 15sec.  
Synchronisation coordonnée via un tableau électrique. Changement séquentiel toutes les 15s.  
Sincronização coordenada através de um painel elétrico. Mudança sequencial a cada 15seg.

### CONTROLADOR/PASARELA DMX RGB

FLEXILIGHT-STRING PLUS

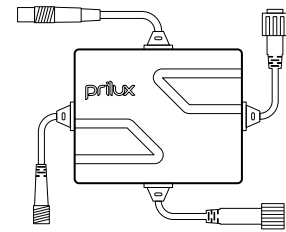

486279



230V



IP55



Max. 2.000leds

Cambio secuencial cada 15seg. si no recibe señal DMX.  
Sequential change every 15sec. if you do not receive DMX signal.  
Changement séquentiel toutes les 15 secondes. si vous ne recevez pas de signal DMX.  
Mudança sequencial a cada 15 seg. se você não receber sinal DMX.

### SINCRONIZADOR GPS RGB

FLEXILIGHT-STRING PLUS-SCREENLIGHT-ICICLE

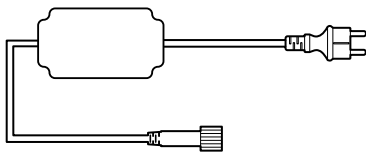

454261



230V



IP55



Max. 2.000leds

Sincronización mediante satélite GPS. Solo uso exterior. Cambio secuencial cada 15seg.  
GPS satellite synchronization. Only outside use. Sequential change every 15sec.  
Synchronisation satellite GPS. Seulement utilisation à l'extérieur. Changement séquentiel toutes les 15s.  
Sincronização por satélite GPS. Apenas fora de uso. Mudança sequencial a cada 15seg.

### CONTROLADOR CW-WW CON MANDO

FLEXILIGHT-STRING PLUS

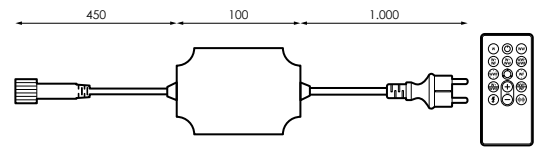

486309



230V



IP55



Max. 2.000leds

Efecto memoria  
Memory effect  
Effet mémoire  
Efeito de memória

### CONTROLADOR POWER LINE CW-WW

FLEXILIGHT-STRING PLUS

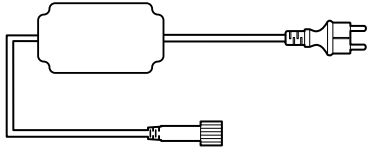

			<b>W</b>
<b>486323</b>	230V	IP55	Max. 2.000leds

Sincronización coordinada mediante una línea eléctrica. Cambio secuencial cada 15seg.  
 Coordinated synchronization through an electrical panel. Sequential change every 15sec.  
 Synchronisation coordonnée via un tableau électrique. Changement séquentiel toutes les 15s.  
 Sincronização coordenada através de um painel elétrico. Mudança sequencial a cada 15seg.

### SINCRONIZADOR GPS CW-WW

FLEXILIGHT-STRING PLUS

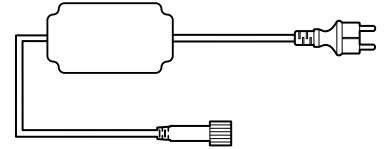

			<b>W</b>
<b>486316</b>	230V	IP55	Max. 2.000leds

Sincronización mediante satélite GPS. Solo uso exterior. Cambio secuencial cada 15seg.  
 GPS satellite synchronization. Only outside use. Sequential change every 15sec.  
 Synchronisation satellite GPS. Seulement utilisation à l'extérieur. Changement séquentiel toutes les 15s.  
 Sincronização por satélite GPS. Apenas fora de uso. Mudança sequencial a cada 15seg.

### CONTROLADOR/PASARELA DMX CW-WW

FLEXILIGHT-STRING PLUS

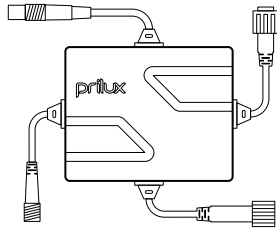

			<b>W</b>
<b>486330</b>	230V	IP55	Max. 2.000leds

Cambio secuencial cada 15seg. si no recibe señal DMX.  
 Sequential change every 15sec. if you do not receive DMX signal.  
 Changement séquentiel toutes les 15 secondes. si vous ne recevez pas de signal DMX.  
 Mudança sequencial a cada 15 seg. se você não receber sinal DMX.

### CONTROLADOR RGB 24V CON MANDO

STRING PLUS

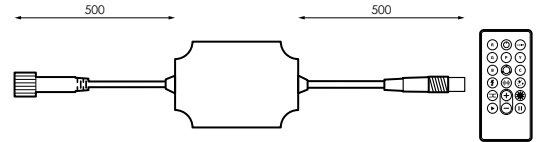

			<b>W</b>
<b>486392</b>	24V	IP55	Max. 400leds

Efecto memoria  
 Memory effect  
 Effet mémoire  
 Efeito de memória

### CONTROLADOR POWER LINE RGB 24V

STRING PLUS



			<b>W</b>
<b>486408</b>	24V	IP55	Max. 400leds

Sincronización coordinada mediante una línea eléctrica. Cambio secuencial cada 15seg.  
 Coordinated synchronization through an electrical panel. Sequential change every 15sec.  
 Synchronisation coordonnée via un tableau électrique. Changement séquentiel toutes les 15s.  
 Sincronização coordenada através de um painel elétrico. Mudança sequencial a cada 15seg.

### CONTROLADOR CW-WW 24V CON MANDO

STRING PLUS

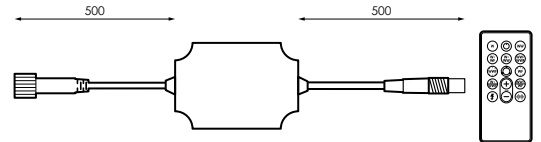

			<b>W</b>
<b>486422</b>	24V	IP55	Max. 400leds

Efecto memoria  
 Memory effect  
 Effet mémoire  
 Efeito de memória

### CONTROLADOR POWER LINE CW-WW 24V

STRING PLUS

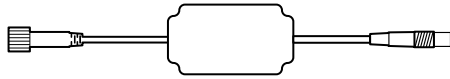

**486439**



24V



IP55



Max. 400leds

Sincronización coordinada mediante una línea eléctrica. Cambio secuencial cada 15seg.  
 Coordinated synchronization through an electrical panel. Sequential change every 15sec.  
 Synchronisation coordonnée via un tableau électrique. Changement séquentiel toutes les 15s.  
 Sincronização coordenada através de um painel elétrico. Mudança sequencial a cada 15seg.

### FUENTE ALIMENTACIÓN 24V

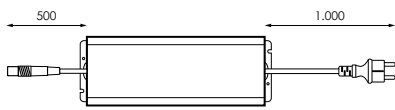

**488440**



24V



30W



IP66/ IP44 Plug

1 salida

**488457**

24V

60W

IP66/ IP44 Plug

1 salida

**488464**

24V

100W

IP66/ IP44 Plug

1 salida

**481687**

24V

150W

IP66/ IP44 Plug

1 salida

**481694**

24V

200W

IP66/ IP44 Plug

2 salidas

### CONECTOR-FUENTE ALIMENTACIÓN

STRING PIXELMAX

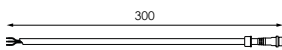

**484305**



CII



IP66

### CONECTOR T

STRING PIXELMAX

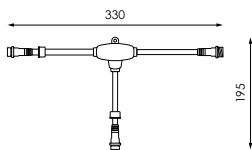

**484343**



IP65

### FUENTE ALIMENTACIÓN 12V

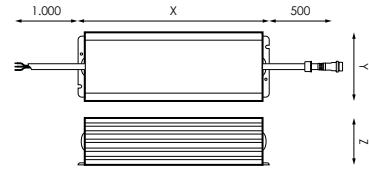

**484282**



12V



IP66



60W



195 x 46 x 32mm 1 salida

**563161**

12V

IP66

250W

273 x 73 x 44mm 4 salidas

### CONECTOR T ENTRADA

MESH PIXELMAX

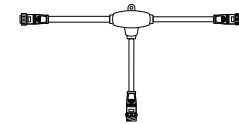

**567992**



IP65

### CONECTOR T ENTRADA

STRING PIXELMAX

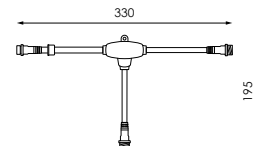

**484299**



IP65

### CONECTOR 3

STRING PIXELMAX

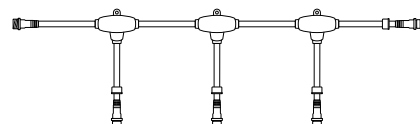

**484350**



IP65

### CONECTOR 5

STRING PIXELMAX

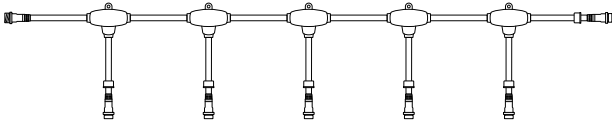

484367



IP65

### CONECTOR-FUENTE ALIMENTACIÓN

DOT DMX PIXELMAX

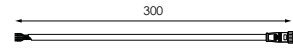

485197



CII



IP66

### EXTENSIÓN

STRING PIXELMAX

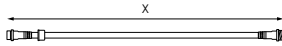

484312



0,25m



IP65

518154

0,50m



IP65

484329

1m



IP65

484336

3m



IP65

518161

5m



IP65

518178

10m



IP65

### EXTENSIÓN

DOT DMX PIXELMAX

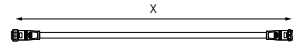

484923



0,25m



IP65

484930

1m



IP65

484947

3m



IP65

### CONECTOR T

DOT DMX PIXELMAX

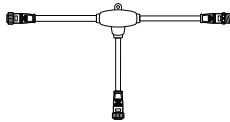

484954



IP65

### CONECTOR 3

DOT DMX PIXELMAX/MESH PIXELMAX

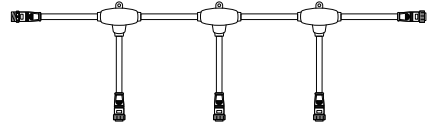

484961



IP65

### CONECTOR 5

DOT DMX PIXELMAX

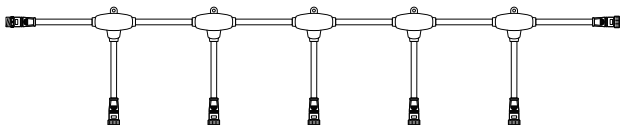

484978



IP65

### CONECTOR T ENTRADA

DOT DMX PIXELMAX

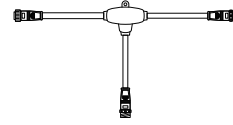

484916



IP65

### TENSOR

MESH PIXELMAX



569989



A Acero

### BLOQUEO

MESH PIXELMAX



569996



A Acero

**CONTROLADOR SPI**

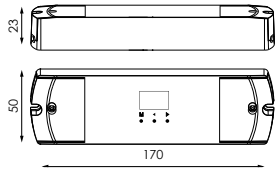

<b>472494</b>	100-240V	IP20	170 x 50 x 23mm

**CONTROLADOR/SLAVE SPI**

8 SALIDAS/32 UNIVERSOS

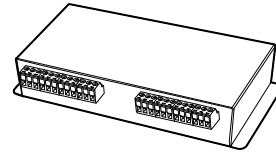

<b>568968</b>	5-24V dc	IP20	Max. 5.440 pixeles

**CONTROLADOR SPI**

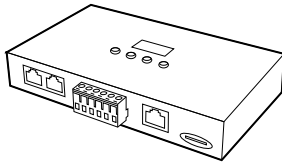

<b>485173</b>	5-24V dc	IP20	4 Salidas/ Max. 680 pixeles
<b>485180</b>	5-24V dc	IP20	4x2 Salidas/ Max. 1.360 pixeles

**CONTROLADOR SPI-DMX**

16 SALIDAS/UNIVERSOS

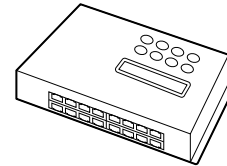

<b>485159</b>	12V dc	IP20	SPI - Max. 21.760 pixeles DMX - Max. 2.048 pixeles

**CONTROLADOR DMX**

8 UNIVERSOS

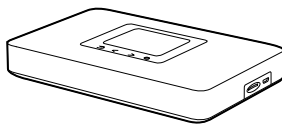

<b>485142</b>	5V dc	IP20	Max. 1.024 pixeles

**CONTROLADOR DMX**

1 UNIVERSO

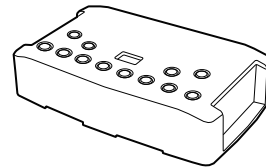

<b>485135</b>	9-36V dc	IP20	Max. 128 pixeles

**CONTROLADOR DMX**

2 CANALES

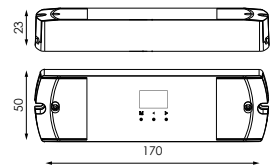

		<b>W</b>			
<b>451154</b>	100-240V	Max. 220W	CII	IP20	2x1A

**FUNCIONES/FUNCTIONS/FONCTIONS/FUNÇÕES**

Modo de regulación 2 canales automático	Automatic 2 channel regulation mode	Mode de régulation automatique à 2 canaux	Modo de regulação automática de 2 canais
Modo dinámico automático	Automatic dynamic mode	Mode dynamique automatique	Modo dinâmico automático
Modo decodificación DMX	DMX decoding mode	Mode de décodage DMX	Modo de decodificação DMX

**AMPLIFICADOR DMX**

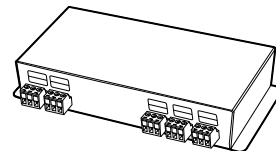

<b>485166</b>	12V dc	IP20

**PF BOX**

SCREEN PIXELMAX

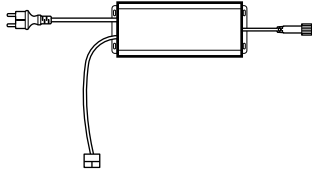

486477

66V

66W

**DIRECCIONADOR DMX**

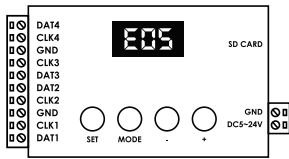

490245

IP20

**BOX MASTER SPI**

4x2 SALIDAS

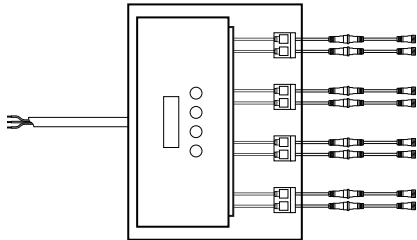

568562

IP65

**CAJA ESTANCA**

CON CONTROLADOR DMX 1 UNIVERSO

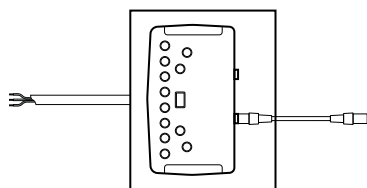

496902

IP65

**CONTROLADOR SLAVE**

SCREEN PIXELMAX

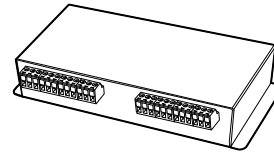

486460

66V

IP20

Max. 3200 pixeles

**BOX MASTER SPI**

4 SALIDAS

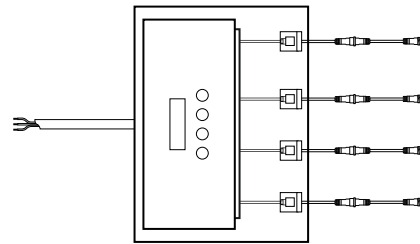

519236

IP65

**BOX MASTER SPI**

16 SALIDAS

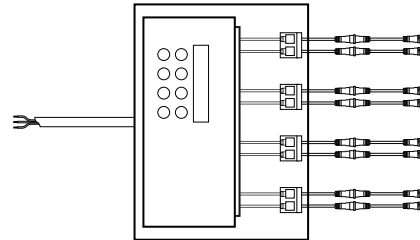

496445

IP65

**BOX CONTROL PARA PRODUCTOS ESTÁTICOS**

2 SALIDAS

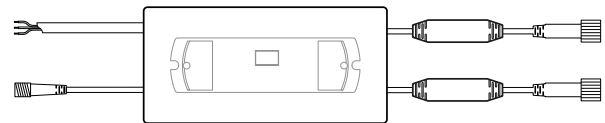

490641

IP65



**BOX CONTROL PARA PRODUCTOS ESTÁTICOS**

6 SALIDAS

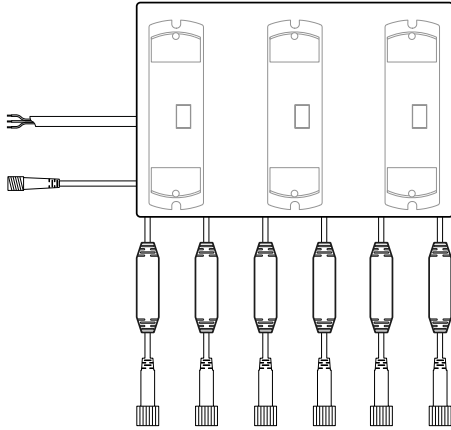

490658



IP65

**BOX CONTROL PARA PRODUCTOS ESTÁTICOS**

10 SALIDAS

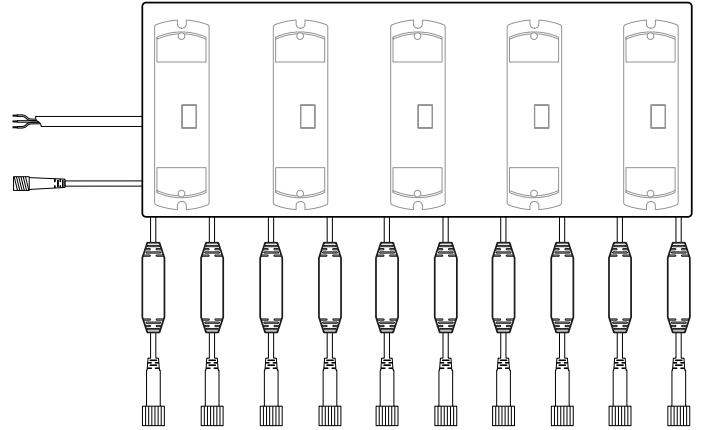

490665



IP65

**MANGUERA DMX**

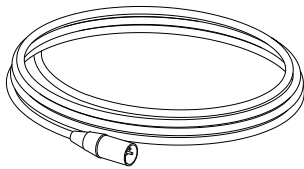

551779



rollo 100m

**CABLE ETHERNET CON ADAPTADOR RJ4**

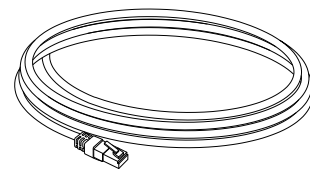

496735



25cm

**CABLE ETHERNET**

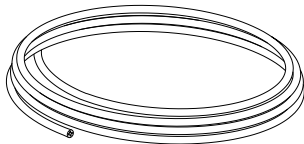

490740



1m

**CABLE ALIMENTACIÓN**

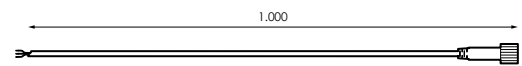

490191



1m



**EXTENSIÓN DMX**

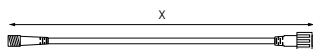

490207



1m



IP44

490214

3m



IP44

490221

5m



IP44

**ADAPTADOR SMART LINK**

SMART-FLEXILIGHT

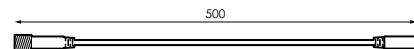

192477



IP65

192453



IP65

Termoretractil y conector macho **NO INCLUIDOS**  
Heat-shrinkable and male connector **NOT INCLUDED**  
Thermorétractable et connecteur mâle **NON INCLUS**  
Tubo de contração térmica e conector macho **NÃO INCLuíDO**

***Flexilight***

---



# flexiLIGHT LED

## 24V



24V dc

CIII

IP44 PLUG

IP54

360°

-20°C~+60 °C

NO INC.

NO INC.

Ñ/ EXTERIOR/TEXTURA LISA/TAPA FINAL INCLUIDA E/ OUTSIDE/SMOOTH TEXTURE/END COVER INCLUDED F/ À L'EXTERIEUR/TEXTURE LISSE/COUVER-CLE INCLUS P/ EXTERIOR/TEXTURA LISA/TAMPA FINAL INCLUIDA

Rota -  
Cádiz

149167		
146432		
191876		
191883		
191906		
191913		

	16,6cm
	13mm
	36
	0,25W
	45W
	Max. 30m
	Rollo 30m

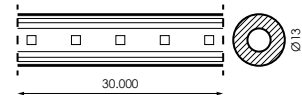

ESQUEMA INSTALACIÓN/  
INSTALLATION SCHEME/  
SCHÉMA D'INSTALLATION/  
ESQUEMA DE INSTALAÇÃO



### Aviso/Warning/Avertissement/Aviso



Ñ/ Uso **OBLIGATORIO** de fuente de alimentación y adaptador.

E/ You **MUST USE** the power supply and adapter.

F/ L'utilisation **OBLIGATOIRE** du alimentation et adaptateur.

P/ Uso **OBRIGATÓRIO** de fonte de alimentação e adaptador.

### Accesorios/Accessories/Accessoires/Acessórios + INFO PAG. 266



Ñ/ Fuente de alimentación y adaptador **NO INCLUIDA**

E/ Power supply and adapter **NOT INCLUDED**

F/ Alimentation et adaptateur **NON INCLUSE**

P/ Fonte de alimentação e adaptador **NÃO INCLuíDO**

**488440**

Fuente alimentación 30W 24V

**481687**

Fuente alimentación 150W 24V

**488457**

Fuente alimentación 60W 24V

**481694**

Fuente alimentación 200W 24V

**488464**

Fuente alimentación 100W 24V

**194556**

Adaptador

# flexiLIGHT LED

## 24V FLASHING

	24V dc
	CIII
	IP44 PLUG
	IP54
	360°
	-20°C~+60 °C
	NO INC.
	NO INC.

Ñ/ EXTERIOR/TEXTURA LISA/TAPA FINAL INCLUIDA E/ OUTSIDE/SMOOTH TEXTURE/END COVER INCLUDED F/ À L'EXTERIEUR/TEXTURE LISSE/COUVERCLE INCLUS P/ EXTERIOR/TEXTURA LISA/TAMPA FINAL INCLUÍDA



Cuidad de Braga 2020  
by AM Illumination  
Producto Prilux

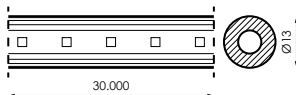

ESQUEMA INSTALACIÓN/  
INSTALLATION SCHEME/  
SCHEMA D'INSTALLATION/  
ESQUEMA DE INSTALAÇÃO



	16,6cm
	13mm
	30+6 flashing
	0,25W
	45W
	Max. 30m
	Rollo 30m

545761		
545778		

### Aviso/Warning/Avertissement/Aviso

Ñ/ Uso **OBLIGATORIO** de fuente de alimentación y adaptador.

E/ You **MUST USE** the power supply and adapter.

F/ L'utilisation **OBLIGATOIRE** du alimentation et adapteur.

P/ Uso **OBRIGATÓRIO** de fonte de alimentação e adaptador.



+ INFO PAG. 266 **Accesorios/Accessories/Accessoires/Acessórios**

Ñ/ Fuente de alimentación y adaptador **NO INCLUIDA**

E/ Power supply and adapter **NOT INCLUDED**

F/ Alimentation et adapteur **NON INCLUSE**

P/ Fonte de alimentação e adaptador **NÃO INCLUÍDO**

<b>488440</b>	Fuente alimentación 30W 24V
<b>481687</b>	Fuente alimentación 150W 24V

<b>488457</b>	Fuente alimentación 60W 24V
<b>481694</b>	Fuente alimentación 200W 24V

<b>488464</b>	Fuente alimentación 100W 24V
<b>194556</b>	Adaptador

# flexiLIGHT LED

## BOMBILLA HORIZONTAL



CC. L'Illa -  
Barcelona

⚡ 230V ac

☐ CII

🌀 1 CANAL/ 2 VÍAS

🔌 IP44 PLUG

🛡️ IP65

⚡ 360°

🌡️ -20°C~+60 °C

🔌 INC.

Ñ/ EXTERIOR/TEXTURA LISA/TAPA  
FINAL INCLUIDA E/ OUTSIDE/SMOOTH  
TEXTURE/END COVER INCLUDED F/ À  
L'EXTERIEUR/TEXTURE LISSE/COUVER-  
CLE INCLUS P/ EXTERIOR/TEXTURA  
LISA/TAMPA FINAL INCLUIDA



952750		
995078		
995085		
952767		
952781		
952774		
952798		
191814		
191807		
952811		
961158		
150316		

	1m
	13mm
	36
	3W
<b>W</b>	135W
	Max. 90m
	Rollo 45m

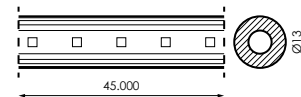

Accesorios/Accessories/Accessoires/Acessórios + INFO PAG. 266











952828  
Cable alimentación Negro

150330  
Cable alimentación Blanco









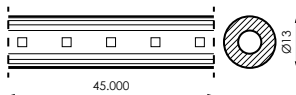



















# flexiLIGHT LED

## FLASHING

	230V ac
	CII
	1 CANAL/ 2 VÍAS
	IP44 PLUG
	IP65
	360°
	-20°C~+60 °C
	INC.

Ñ/ EXTERIOR/TEXTURA LISA/TAPA FINAL INCLUIDA E/ OUTSIDE/SMOOTH TEXTURE/END COVER INCLUDED F/ À L'EXTERIEUR/TEXTURE LISSE/COUVERCLE INCLUS P/ EXTERIOR/TEXTURA LISA/TAMPA FINAL INCLUÍDA



	1,5m			
	13mm	484190		
	30+6 flashing	970853		
	3.5W *4,2W	953368		
	105W *125W	386944		
	Max. 90m	386951		
	Rollo 45m	386968*		
		386975*		
		386982		
		386999		



+ INFO PAG. 266 **Accesorios/Accessories/Accessoires/Acessórios**

**952828**

Cable alimentación Negro

**150330**

Cable alimentación Blanco

# flexiLIGHT LED

## BOMBILLA VERTICAL



Arucas -  
Gran Canarias

⚡ 230V ac

☐ CII

🔌 1 CANAL/ 2 VÍAS

🔌 IP44 PLUG

🔌 IP65

⚡ 120°

🌡️ -20°C~+60 °C

🔌 INC.

Ñ/ EXTERIOR/TEXTURA LISA/TAPA  
FINAL INCLUIDA E/ OUTSIDE/SMOOTH  
TEXTURE/END COVER INCLUDED F/ À  
L'EXTERIEUR/TEXTURE LISSE/COVER-  
CLE INCLUS P/ EXTERIOR/TEXTURA  
LISA/TAMPA FINAL INCLUIDA



	💡	∞
163347	LED	🔌
163392	LED	🔌
163354	LED	🔌
163378	LED	🔌
163385	LED	🔌
163361	LED	🔌

✂️	1,5m
∅	13mm
💡	36
W/⚡	3,5W
W	105W
🔌	Max. 90m
📦	Rollo 45m

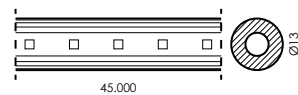

Accesorios/Accessories/Accessoires/Acessórios + INFO PAG. 266









952828  
Cable alimentación Negro

150330  
Cable alimentación Blanco



# flexiLIGHT LED

## DUAL





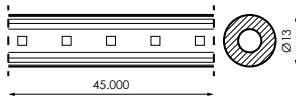

	230V ac
	CII
	IP44 PLUG
	IP54
	360°
	-20°C~+60 °C
	INC.

Ñ/ EXTERIOR/TEXTURA LISA/TAPA FINAL INCLUIDA E/ OUTSIDE/SMOOTH TEXTURE/END COVER INCLUDED F/ À L'EXTERIEUR/TEXTURE LISSE/COUVERCLE INCLUS P/ EXTERIOR/TEXTURA LISA/TAMPA FINAL INCLUIDA



El Pozo -  
Alama de Murcia



	1m
	13mm
	36
	3W
	135W
	Ver acces.
	Rollo 45m

		
191821		



Aviso/Warning/Avertissement/Aviso

Ñ/Los efectos de cambio de color solo funcionan con el controlador que es de **USO OBLIGATORIO**.

E/ The color change effects only work with the controller that is **OBLIGATORY**.

F/ Les effets de changement de couleur fonctionnent uniquement avec le contrôleur qui est **OBLIGATOIRE**.

P/ Os efeitos de mudança de cor funcionam apenas com o controlador que é **USO OBRIGATÓRIO**.



+ INFO PAG. 266

Accesorios/Accessories/Accessoires/Acessórios

Ñ/La máxima longitud por alimentación, dependerá del controlador a utilizar.

E/ Maximum length for power, will depend on the driver to use.

F/ Longueur maximale pour le pouvoir, dépendra le pilote à utiliser.

P/ Comprimento máximo para o poder, vai depender do driver para uso.

391559

Controlador dual 8 Funciones (Necesita adaptador)

194556

Adaptador 24V a Flexilight

971072

Controlador dual 4 Funciones (Necesita adaptador)

# flexiLIGHT LED AVANT

## IP67



Plaza Lagos - Ecuador

⚡ 230V ac

☐ CII

🗣️ 1 CANAL/ 2 VÍAS

🔌 IP44 PLUG

🌧️ IP67

⚡ 360°

🌡️ -20°C~+60 °C

🇪🇺 INC.

Ñ/ EXTERIOR/TEXTURA LISA/TAPA FINAL INCLUIDA E/ OUTSIDE/SMOOTH TEXTURE/END COVER INCLUDED F/ À L'EXTERIEUR/TEXTURE LISSE/COUVER-CLE INCLUS P/ EXTERIOR/TEXTURA LISA/TAMPA FINAL INCLUIDA



488655		
488648		
488662		
488679		
488686		
488693		

	1m
	13mm
	36
	3W
	135W
	Max. 90m
	Rollo 45m

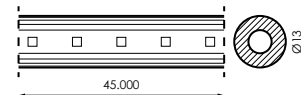

### Aviso/Warning/Avertissement/Aviso



Ñ/ Para que la conexión a la línea eléctrica sea IP67, la alimentación deberá ir en caja estanca. Perda de IP al cortar el producto.

E/ In order for the connection to the powerline to be IP67, the power supply must be in a sealed box. Loss of IP when cutting the product.

F/ Pour que la connexion à la ligne électrique soit IP67, l'alimentation doit être dans un boîtier scellé. Perte de propriété intellectuelle lors de la découpe du produit.

P/ Para que a conexão à linha de energia seja IP67, a fonte de alimentação deve estar em uma caixa selada. Perda de IP ao cortar o produto.

### Accesorios/Accessories/Accessoires/Acessórios + INFO PAG. 266











487184  
Cable alimentación Negro

487191  
Cable alimentación Blanco

Hasta cinco años de garantía  
Up to five years of warranty  
Jusqu'à cinq ans de garantie  
Até cinco anos de garantia







5

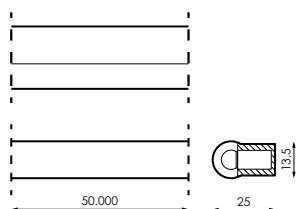





# flexiLIGHT LED NEON

	230V ac
	CII
	1 CANAL/ 2 VÍAS
	IP44 PLUG
	IP66
	120°
	-25°C~+60 °C
	INC.

**Ñ**/ IDEAL PARA INSTALACIONES FIJAS DE EXTERIOR **E**/ IDEAL FOR OUTSIDE INSTALLATIONS **F**/ IDEAL POUR SERVICES A L'EXTERIEUR FIXES **P**/ IDEAL PARA INSTALAÇÕES EXTERIOR FIXA



	50cm
	13,5x25mm
	120
	5W
	500W
	Max. 50m
	Rollo 50m

		
445603		
445610		



Aviso/Warning/Avertissement/Aviso

**Ñ**/ Cada rollo se sirve con dos cables de alimentación y tapa final. Regulable con TRIAC que realice el corte a principio y fin de fase indistintamente.

**E**/ Each roll is served with two power cords and end cover. Adjustable with TRIAC that performs the cut at the beginning and end of the phase interchangeably.

**F**/ Chaque rouleau est servi avec deux cordons d'alimentation et couvercle. Réglable avec TRIAC qui effectue la coupe au début et à la fin de la phase de manière interchangeable.

**P**/Cada rolo é servido com dois cabos de alimentação e tampa final. Ajustável com TRIAC que executa o corte no início e no final da fase de maneira intercambiável.



+ INFO PAG. 266 **Accesorios/Accessories/Accessoires/Acessórios**

<b>445627</b>	Cable alimentación Blanco
<b>445641</b>	Empalme L

<b>445634</b>	Empalme simple
<b>445665</b>	Canaleta 1m

<b>445658</b>	Tapa final
<b>445689</b>	Pegamento

<b>445672</b>	Clip sujección
---------------	----------------

# flexiLIGHT LED

## NEON 360°

# 2

Hasta dos años de garantía  
Up to two years of warranty  
Jusqu'à deux ans de garantie  
Até dois anos de garantia



230V ac

CII

1 CANAL/ 2 VÍAS

IP44 PLUG

IP65

360°

-20°C~+60 °C

INC.

Ñ/ EXTERIOR/TEXTURA LISA/TAPA  
FINAL INCLUIDA E/ OUTSIDE/SMOOTH  
TEXTURE/END COVER INCLUDED F/ À  
L'EXTERIEUR/TEXTURE LISSE/COVER-  
CLE INCLUS P/ EXTERIOR/TEXTURA  
LISA/TAMPA FINAL INCLUIDA

546317		
546324		

	1m
	14mm
	240
	9,5W
	475W
	Max. 50m
	Rollo 50m

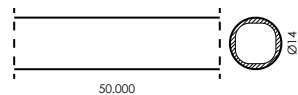

Accesorios/Accessories/Accessoires/Acessórios + INFO PAG. 266



**546393**  
Cable alimentación Blanco

**546409**  
Empalme simple

**546416**  
Tapa final









**546423**  
Clip sujeción

Hasta dos años de garantía  
Up to two years of warranty  
Jusqu'à deux ans de garantie  
Até dois anos de garantia

2

# flexiLIGHT LED

## MINI NEON SLIM





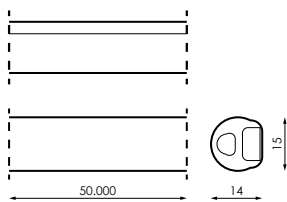

	230V ac
	CII
	1 CANAL/ 2 VÍAS
	IP44 PLUG
	IP65
	360°
	-20°C~+60 °C
	INC.

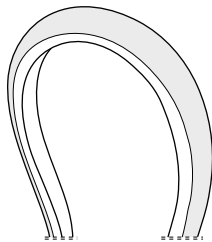





Ñ/ EXTERIOR/TEXTURA LISA/TAPA FINAL INCLUIDA E/ OUTSIDE/SMOOTH TEXTURE/END COVER INCLUDED F/ À L'EXTERIEUR/TEXTURE LISSE/COUVERCLE INCLUS P/ EXTERIOR/TEXTURA LISA/TAMPA FINAL INCLUÍDA



ESQUEMA DE DOBLADO



	1m
	15x14mm
	120
	9W
	450W
	Max. 50m
	Rollo 50m

		
546355		
546362		



+ INFO PAG. 266

Accesorios/Accessories/Accessoires/Acessórios

**546478**  
Cable alimentación Blanco

**546485**  
Empalme simple

**546492**  
Tapa final

**546508**  
Clip sujeción

# flexiLIGHT LED

## MINI NEON

**2** Hasta dos años de garantía  
Up to two years of warranty  
Jusqu'à deux ans de garantie  
Até dois ans de garantie

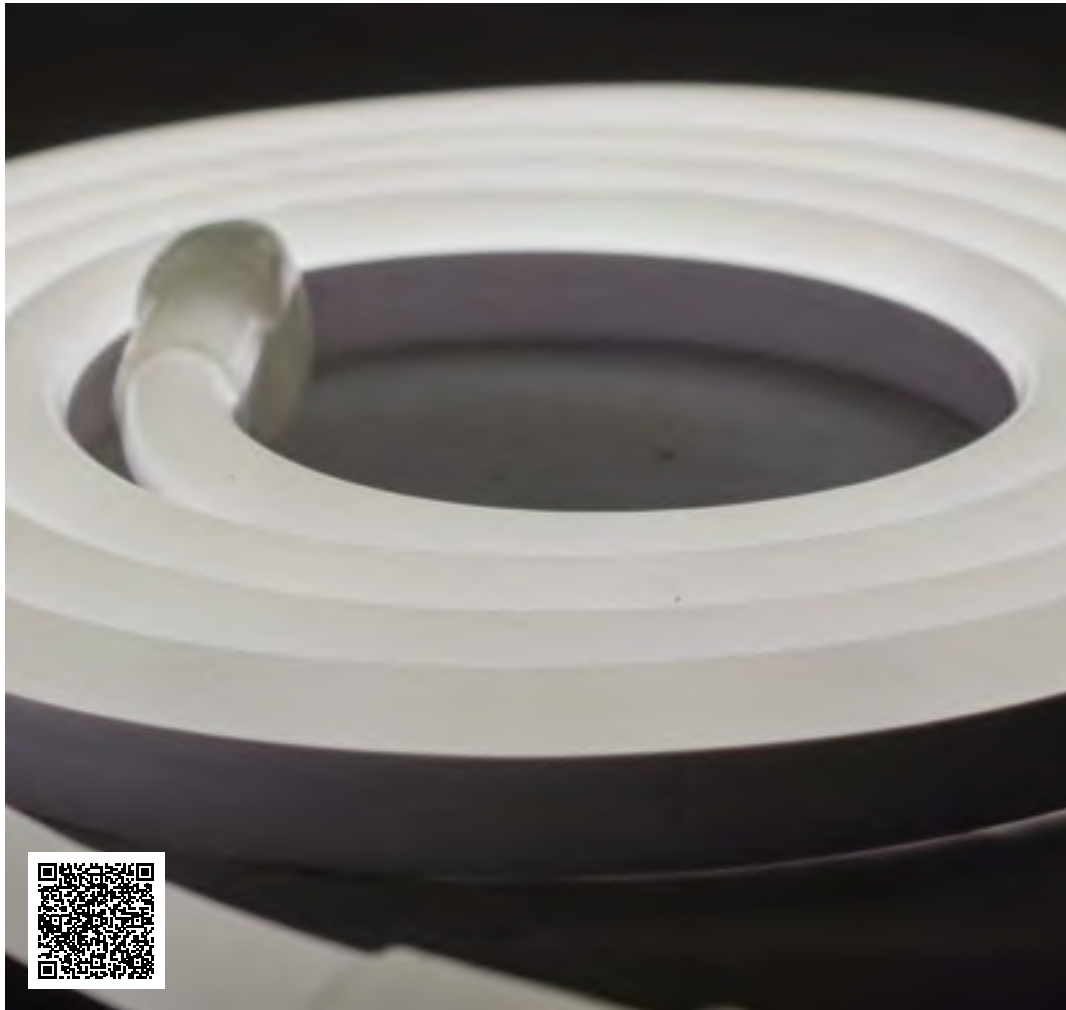

⚡ 230V ac

□ CII

⊕⊖ 1 CANAL/ 2 VÍAS

⊕⊖ IP44 PLUG

⊕⊖ IP65

△ 360°

ℹ -20°C~+60 °C

♻ INC.

Ñ/ EXTERIOR/TEXTURA LISA/TAPA  
FINAL INCLUIDA E/ OUTSIDE/SMOOTH  
TEXTURE/END COVER INCLUDED F/ À  
L'EXTERIEUR/TEXTURE LISSE/COVER-  
CLE INCLUS P/ EXTERIOR/TEXTURA  
LISA/TAMPA FINAL INCLUIDA

546331		
546348		

	1m
	12x20mm
	120
	9W
	450W
	Max. 50m
	Rollo 50m

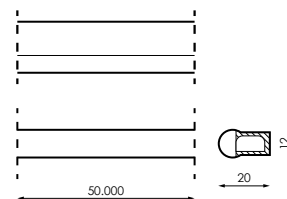

ESQUEMA DE DOBLADO



Accesorios/Accessories/Accessoires/Acessórios + INFO PAG. 266



**546430**  
Cable alimentación Blanco

**546447**  
Empalme simple

**546454**  
Tapa final

**546461**  
Clip sujeción

Hasta dos años de garantía  
Up to two years of warranty  
Jusqu'à deux ans de garantie  
Até dois ans de garantie

2

# flexiLIGHT LED

## DOUBLE NEON

	230V ac
	CII
	1 CANAL/ 2 VÍAS
	IP44 PLUG
	IP65
	360°
	-20°C~+60 °C
	INC.

Ñ/ EXTERIOR/TEXTURA LISA/TAPA FINAL INCLUIDA E/ OUTSIDE/SMOOTH TEXTURE/END COVER INCLUDED F/ À L'EXTERIEUR/TEXTURE LISSE/COUVERCLE INCLUS P/ EXTERIOR/TEXTURA LISA/TAMPA FINAL INCLUIDA

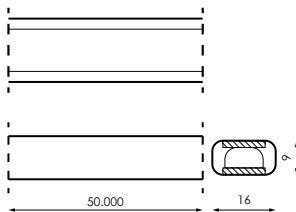
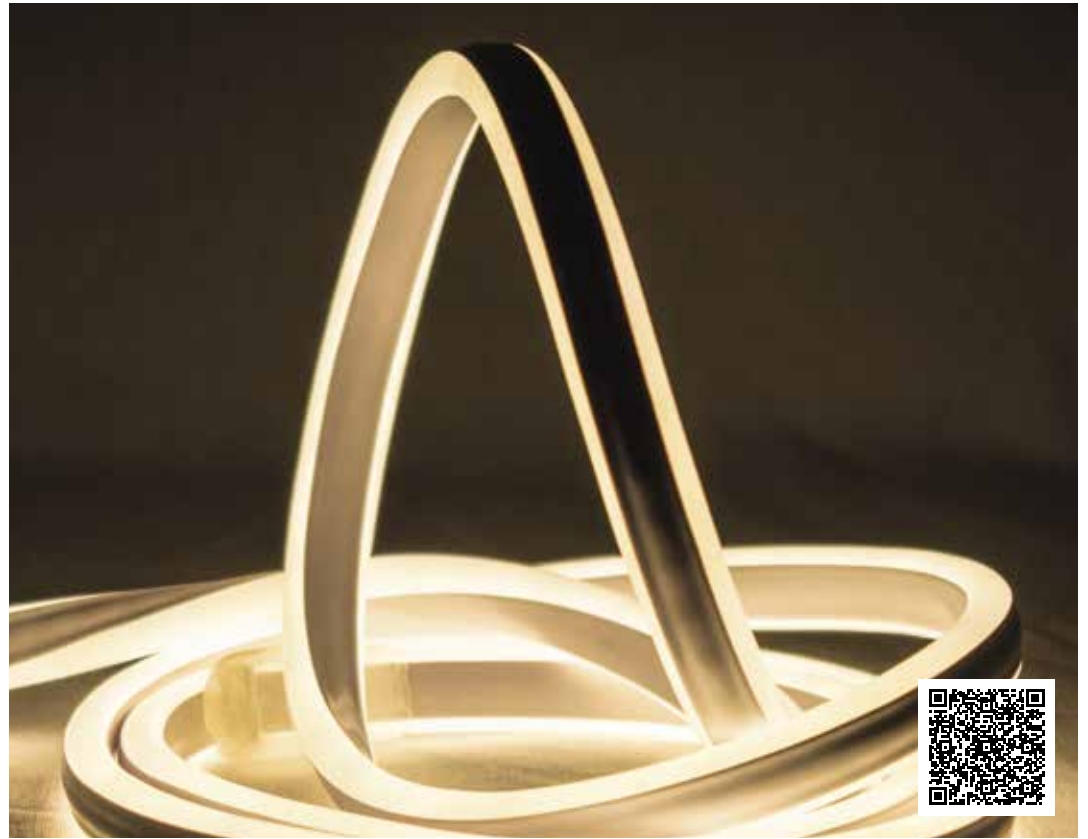

ESQUEMA DE DOBLADO

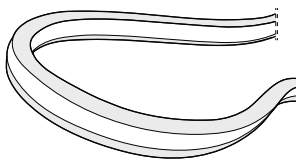

	1m
	9x16mm
	120
	9W
	450W
	Max. 50m
	Rollo 50m

546379		
546386		
481588		
481571		
481564		
481595		



+ INFO PAG. 266 **Accesorios/Accessories/Accessoires/Acessórios**

<b>546515</b>
Cable alimentación Blanco
<b>518635</b>
Adaptador Smart Link a Flexilight Double Neon
<b>523622</b>
Extensión 50cm blanco

<b>546522</b>
Empalme simple
<b>523615</b>
Adaptador Flexilight Double Neon a Smart Link
<b>566377</b>
Extensión 1m Blanco

<b>546539</b>
Tapa final
<b>518611</b>
Conector macho

<b>546546</b>
Clip sujección
<b>523639</b>
Empalme sencillo

# flexiLIGHT LED

## MAXIBRILLO

**2** Hasta dos años de garantía  
Up to two years of warranty  
Jusqu'à deux ans de garantie  
Até dois ans de garantie



	230V ac
	CII
	1 CANAL/ 2 VÍAS
	IP44 PLUG
	IP65
	120°
	-20°C~+60 °C
	INC.

**Ñ/ EXTERIOR/TEXTURA LISA/TAPA FINAL INCLUIDA E/ OUTSIDE/SMOOTH TEXTURE/END COVER INCLUDED F/ À L'EXTERIEUR/TEXTURE LISSE/COUVER-CLE INCLUS P/ EXTERIOR/TEXTURA LISA/TAMPA FINAL INCLUIDA**

210706		
210683		
388764		
388771		
388788		
388795		

	1m
	11,5x6mm
	60
	9W
<b>W</b>	450W
	Max. 50m
	Rollo 50m

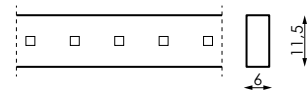

### Accesorios/Accessories/Accessoires/Acessórios + INFO PAG. 266



<b>210713</b>
Cable alimentación Negro
<b>210751</b>
Empalme L

<b>210744</b>
Empalme simple
<b>383929</b>
Conector macho

<b>210737</b>
Tapa final

<b>210768</b>
Clip sujeción



Hasta dos años de garantía  
Up to two years of warranty  
Jusqu'à deux ans de garantie  
Até dois anos de garantia









2

# flexiLIGHT LED

## BRITE







Nuevo  
New  
Nouveau  
Novo

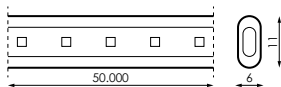
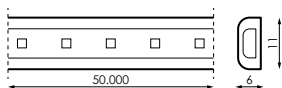











N

	230V ac
	CII
	1 CANAL/ 2 VÍAS
	IP44 PLUG
	IP65
	120°
	-25°C~+60 °C
	INC.

Ñ/ EXTERIOR/TEXTURA LISA/TAPA FINAL INCLUIDA E/ OUTSIDE/SMOOTH TEXTURE/END COVER INCLUDED F/ À L'EXTERIEUR/TEXTURE LISSE/COUVERCLE INCLUS P/ EXTERIOR/TEXTURA LISA/TAMPA FINAL INCLUÍDA



	1m
	11x6mm
	60
	5,5W
	275W
	Max. 100m
	Rollo 50m

		
442688		
442671		
442695		
Ñ 563345*		
Ñ 563321*		



+ INFO PAG. 266 **Accesorios/Accessories/Accessoires/Acessórios**

<b>442701</b>	Cable alimentación Blanco
<b>442763</b>	Conector L
<b>442718</b>	Conector macho

<b>442794</b>	Tapa final
<b>442770</b>	Conector X
<b>442756</b>	Canaleta 1m

<b>442725</b>	Empalme
<b>442800</b>	Adaptador Smart Link-Flexilight Brite
<b>442787</b>	Extensión 0,5m

<b>442732</b>	Empalme estanco
<b>442817</b>	Adaptador Flexilight Brite-Smart Link
<b>442749</b>	Clip sujeción

# flexiLIGHT

## INSTANT LISO



⚡ 230V ac

☐ CII

👁️ 1 CANAL/ 2 VÍAS

🔌 IP44 PLUG

🛡️ IP65

⚡ 120°

🌡️ -20°C~+60 °C

🔌 INC.

Ñ/ EXTERIOR/TEXTURA LISA/BOMBILLA FUSIBLE E/ OUTSIDE/SMOOTH TEXTURE/BULB FUSE F/ À L'EXTERIEUR/TEXTURE LISSE/AMPOULE FUSIBLE P/ EXTERIOR/TEXTURA LISA/FUSÍVEL DE BULBO



002684		
002691		
002714		
002721		
002707		
002738		

	1m
	13mm
	36
	16,56W
	828W
	Max. 100m
	Rollo 50m

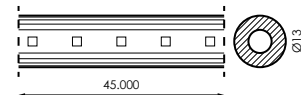

Accesorios/Accessories/Accessoires/Acessórios + INFO PAG. 266











096744  
Cable alimentación Negro

972222  
Cable alimentación Blanco sin shucko

972239  
Cable alimentación Negro sin shucko

# flexiLIGHT LED

Ø11mm





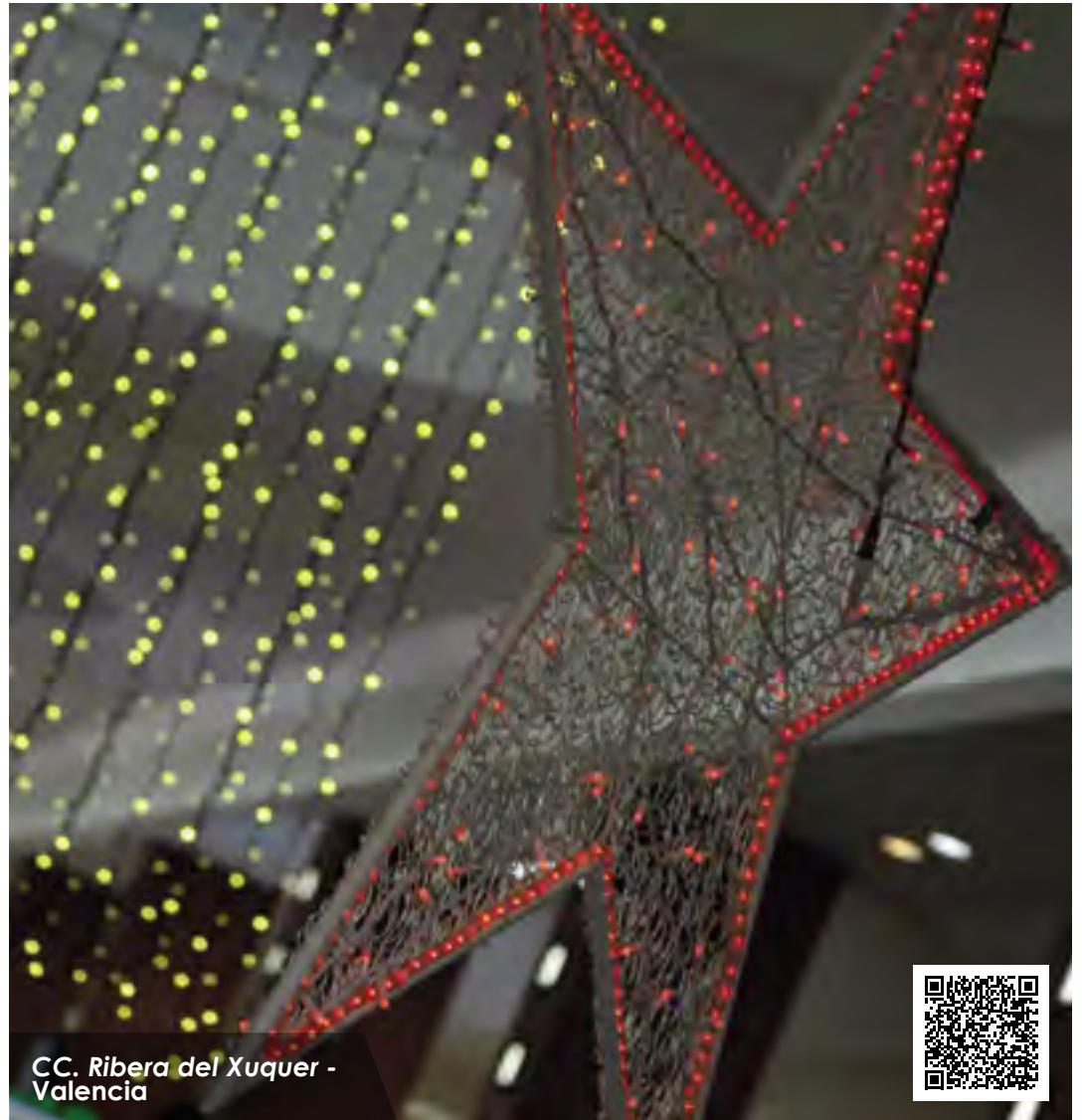



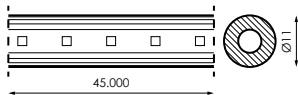













	230V ac
	CII
	1 CANAL/ 2 VÍAS
	IP44 PLUG
	IP65
	360°
	-20°C~+60 °C
	INC.

Ñ/ EXTERIOR/TEXTURA LISA/TAPA FINAL INCLUIDA E/ OUTSIDE/SMOOTH TEXTURE/END COVER INCLUDED F/ À L'EXTERIEUR/TEXTURE LISSE/COUVERCLE INCLUS P/ EXTERIOR/TEXTURA LISA/TAMPA FINAL INCLUÍDA



CC. Ribera del Xuquer - Valencia



	1m			
	11mm	953375		
	36	191937		
	3W	953382		
	135W	953399		
	Max. 90m	953450		
	Rollo 45m	953467		



+ INFO PAG. 266 **Accesorios/Accessories/Accessoires/Acessórios**

953474

Cable alimentación Negro

391542

Cable alimentación Blanco

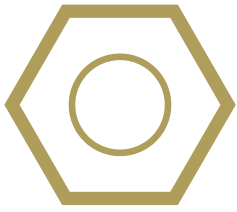

# Accesorios

Accessories  
Accessoires  
Acessórios

		flexiLIGHT 24V	flexiLIGHT 24V FLASHING	flexiLIGHT BOMB. HORIZONTAL	flexiLIGHT FLASHING	flexiLIGHT BOMB. VERTICAL	flexiLIGHT AVANT P67	flexiLIGHT NEON 360°	flexiLIGHT MINI NEON SLIM	flexiLIGHT MINI NEON	flexiLIGHT DOUBLE NEON	flexiLIGHT NEON	flexiLIGHT MAXIBRILLO	flexiLIGHT BRITE	flexiLIGHT DUAL	flexiLIGHT INSTANT	flexiLIGHT Ø11mm
	006590																•
	096744															•	•
	150330			•	•	•											
	210713												•				
	391542																•
	442701													•			
	445627											•					
	481687	•	•														
	481694	•	•														
	487184						•										
	487191						•										
	488440	•	•														
	488457	•	•														
	488464	•	•														
	546393							•									
	546430								•								
	546478							•									
	546515									•							
	952828			•	•	•											
	953474																•
	972222															•	
	972239															•	
	391559														•		
	971072														•		
	006200	•	•	•	•	•									•	•	
	210768												•				
	442749													•			
	442756													•			
	445665											•					
	445672											•					
	446761	•	•	•	•	•									•	•	
	546423							•									
	546461								•								
	546508								•								
	546546										•						
	002776	•	•	•	•	•									•	•	
	006408	•	•	•	•	•									•	•	
	006606																•
	006941	•	•	•	•	•									•	•	
	010795																•
	010818			•	•	•									•	•	
	064354	•	•	•	•	•									•	•	
	064729	•	•	•	•	•									•	•	

		flexiLIGHT 24V	flexiLIGHT 24V FLASHING	flexiLIGHT BOMB. HORIZONTAL	flexiLIGHT FLASHING	flexiLIGHT BOMB. VERTICAL	flexiLIGHT AVANTIP67	flexiLIGHT NEON 360°	flexiLIGHT MINI NEON SLIM	flexiLIGHT MINI NEON	flexiLIGHT DOUBLE NEON	flexiLIGHT NEON	flexiLIGHT MAXIBRILLO	flexiLIGHT BRITE	flexiLIGHT DUAL	flexiLIGHT INSTANT	flexiLIGHT Ø11mm
	068017																•
	068048																•
	084727	•	•	•	•	•									•	•	
	097109	•	•	•	•	•	•								•	•	•
	194556	•	•												•		
	210744												•				
	210751												•				
	236010	•	•	•	•	•									•	•	
	383929												•				
	388405	•	•	•	•	•									•	•	
	388559																•
	398121																•
	442718													•			
	442725													•			
	442732													•			
	442763													•			
	442770													•			
	442787													•			
	442800													•			
	442817													•			
	445634											•					
	445641											•					
	445689											•					
	518611										•						
	518635										•						
	523615										•						
	523622										•						
	523639																
	546409						•										
	546447								•								
	546485							•									
	546522									•							
	566377																
	971195														•		
	971201														•		
	971218														•		
	001717																•
	011853			•	•	•										•	
	210737												•				
	442794													•			
	445658											•					
	546416						•										
	546454								•								
	546492								•								
	546539										•						

## FUENTE ALIMENTACIÓN 24V

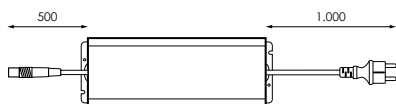

Barcode	Voltage	Power (W)	IP Rating / Plug
488440	24V	30W	IP66/ IP44 Plug
488457	24V	60W	IP66/ IP44 Plug
488464	24V	100W	IP66/ IP44 Plug
481687	24V	150W	IP66/ IP44 Plug
481694	24V	200W	IP66/ IP44 Plug

## CABLE ALIMENTACIÓN Ø13mm

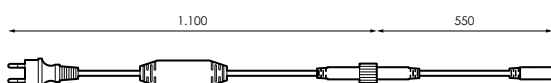

Barcode	Voltage	Power (W)	IP Rating	Plug / Connector
952828	230Vac	Max. 480W	CII	IP44 Plug IP65 Conector
150330	230Vac	Max. 480W	CII	IP44 Plug IP65 Conector

## CABLE ALIMENTACIÓN Ø11mm

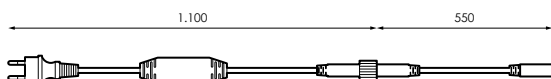

Barcode	Voltage	Power (W)	IP Rating	Plug / Connector
953474	230Vac	Max. 480W	CII	IP44 Plug IP65 Conector
391542	230Vac	Max. 480W	CII	IP44 Plug IP65 Conector

## CABLE ALIMENTACIÓN Ø13mm

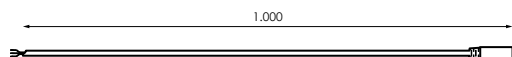

Barcode	Voltage	IP Rating	Plug / Connector
972239	230V	CII	
972222	230V	CII	

## ADAPTADOR 24V/DUAL

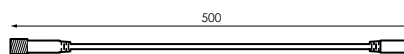

Barcode	Description
194556	Adaptador del rectificador a Flexilight Led Adapter of rectifier to Flexilight Led Adaptateur redresseur à Flexilight Led Adaptador de reficador para Flexilight Led

## CABLE ALIMENTACIÓN AVANT Ø13mm

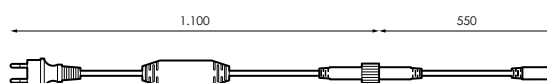

Barcode	Voltage	Power (W)	IP Rating	Plug / Connector
487184	230Vac	Max. 480W	CII	IP44 Plug IP67 Conector
487191	230Vac	Max. 480W	CII	IP44 Plug IP67 Conector

## CABLE ALIMENTACIÓN

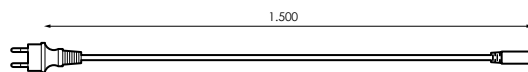

Barcode	Description
096744	FLEXILIGHT 13mm
006590	FLEXILIGHT 11mm Horizontal

## CONECTOR Y

PVC/1 canal

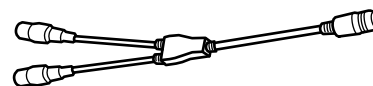

Barcode	Description
084727	Flexilight 13mm
006606	Flexilight 11mm

### CONECTOR X

PVC/1 canal

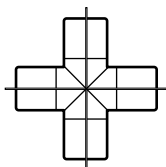

**010795** Flexilight 11mm

**068048** Flexilight 11mm

### EXTENSIÓN

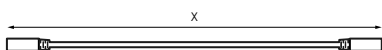

**388405** Empalme simple 0,5m 13mm 1 canal  
Simple joint 0,5m 1cannal 13mm  
Articulation simple 0,5m 1canal 13mm  
Junção simples 0,5m 13mm 1canal

**236010** Empalme simple 1m 13mm 1 canal  
Simple joint 1m 1cannal 13mm  
Articulation simple 1m 1canal 13mm  
Junção simples 1m 13mm 1canal

**006941** Empalme simple 3m 13mm 1 canal  
Simple joint 3m 1cannal 13mm  
Articulation simple 3m 1canal 13mm  
Junção simples 3m 13mm 1canal

Termoretractil y conector macho **NO INCLUIDOS**  
Heat-shrinkable and male connector **NOT INCLUDED**  
Thermorétractable et connecteur mâle **NON INCLUS**  
Tubo de contração térmica e conector macho **NÃO INCLUÍDO**

### EMPALME ESTANCO

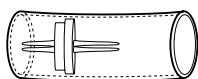

**010818** Flexilight 13mm

**068017** Flexilight 11mm

### EMPALME SENCILLO

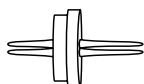

**002776** Flexilight 13mm

**398121** Flexilight 11mm

### CONECTOR T

PVC/1 canal

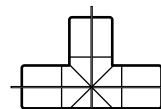

**064729** Flexilight 13mm

**006408** Flexilight 13mm

### TERMORRETRACTIL

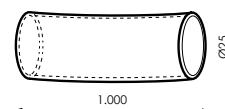

**097109** Ø19,1mm para Flexilight. Recubrimiento interior de resina termoplástica. Rollo 1m.  
Ø19,1mm for Flexilight. Thermoplastic resin inner lining. Roll 1m.  
Ø19,1mm pour Flexilight. Doublure intérieure en résine thermoplastique. Rouler 1m.  
Ø19,1mm para Flexilight. Revestimento interno em resina termoplástica. Roll 1m.

**972451** Pistola aire caliente profesional 2000W  
Hot air gun professional 2000W  
Pistolet à air chaud 2000W professionnel  
Soprador de ar quente 2000W profissional

### CONECTOR MACHO

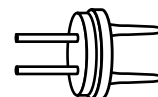

**388559** Flexilight 11mm

**064354** Flexilight 13mm

### TAPA FINAL

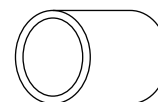

**011853** Flexilight 13mm

**001717** Flexilight 11mm

### CLIP SUJECCIÓN



446761

Flexilight 13mm

### CANALETA Ø13mm



006200



2m



T Transparente

### CONTROLADOR DUAL

2A

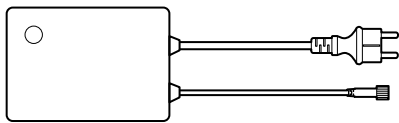

### CONTROLADOR DUAL

6A

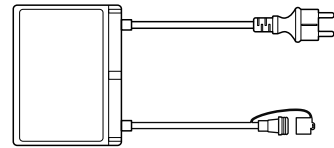

391559



230V

W

Max. 240W

8 funciones efecto memoria  
8 functions memory effect  
8 fonctions effet mémoire  
8 funções efeito de memória



971072



230V

W

Max. 1.200W



\*Max. 240m

\*Máx. 240m (máx. 90m por saída)/ 4 funciones  
\*Max. 240m (max. 90m per output)/ 4 functions  
\*Max. 240m (max. 90m par sortie)/ 4 fonctions  
\*Max. 240m (max. 90m por saída)/ 4 funções

### CONECTOR DUAL

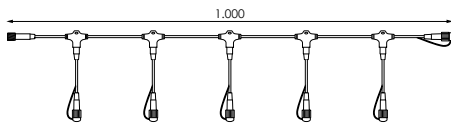

971201

5 Portalámparas (1m)  
5 Lampholders (1m)  
5 Douilles (1m)  
5 Portalâmpadas (1m)

### CONECTOR DUAL

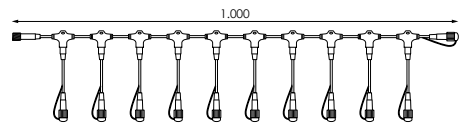

971195

10 Portalámparas (1m)  
10 Lampholders (1m)  
10 Douilles (1m)  
10 Portalâmpadas (1m)

### EXTENSION-CONECTOR DUAL

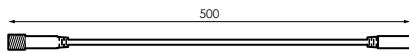

194549

Extensión conector dual a Flexilight Led dual  
Extension dual connector to Flexilight Led dual  
Extension connecteur double à Flexilight Led double  
Extensão conector duplo para Flexilight Led duplo

### CONECTOR DUAL

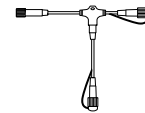

971218

Conector T  
Connector T  
Connecteur en T  
Conector em T



### CABLE ALIMENTACIÓN NEON 360°

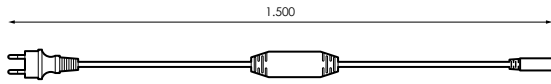

546393



230Vac/dc

IP44 Plug  
IP65 Conector

### EMPALME NEON 360°

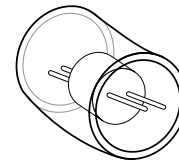

546409

Blanco

### CLIP SUJECCIÓN NEON 360°



546423

Transparente

### TAPA FINAL NEON 360°

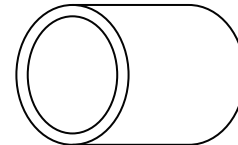

546416

Transparente

### CABLE ALIMENTACIÓN MINI NEON SLIM

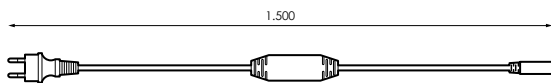

546478



230Vac/dc

IP44 Plug  
IP65 Conector

### EMPALME MINI NEON SLIM

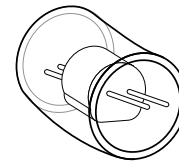

546485

Blanco

### CLIP SUJECCIÓN MINI NEON SLIM

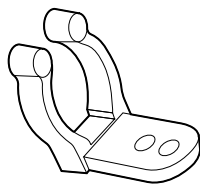

546508

Transparente

### TAPA FINAL MINI NEON SLIM

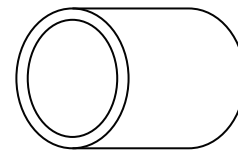

546492

Transparente

### CABLE ALIMENTACIÓN MINI NEON

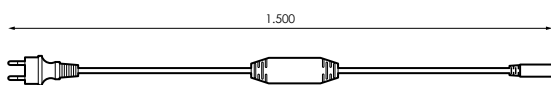

546430



230Vac/dc

IP44 Plug  
IP54 Conector

### EMPALME MINI NEON

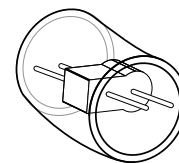

546447

Blanco

### CLIP SUJECCIÓN MINI NEON

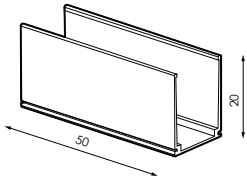

546461



**A** Aluminio

### TAPA FINAL MINI NEON

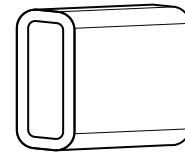

546454



**T** Transparente

### CABLE ALIMENTACIÓN DOUBLE NEON

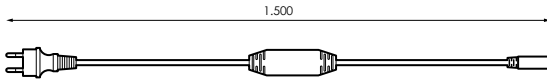

546515



230Vac/dc



IP44 Plug  
IP65 Conector

### EMPALME DOUBLE NEON

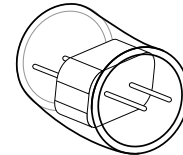

546522



**BI** Blanco

### CLIP SUJECCIÓN DOUBLE NEON

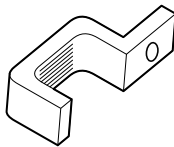

546546



**T** Transparente

### TAPA FINAL DOUBLE NEON

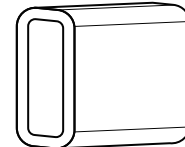

546539



**T** Transparente

### ADAPTADOR SMART LINK-FLEXILIGHT DOUBLE NEON

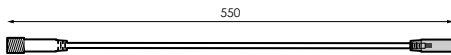

518635



**BI** Blanco

### ADAPTADOR FLEXILIGHT DOUBLE NEON-SMART LINK

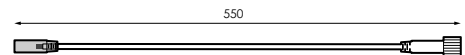

523615



**BI** Blanco

### EMALME SENCILLO DOUBLE NEON

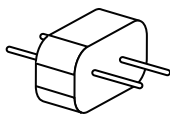

523639



**T** Transparente

### CONECTOR MACHO DOUBLE NEON

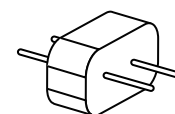

518611



**T** Transparente

### EXTENSIÓN DOUBLE NEON

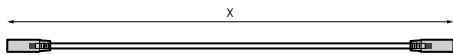

523622

0,5m

BI Blanco

566377

1m

BI Blanco

### CABLE ALIMENTACIÓN NEON

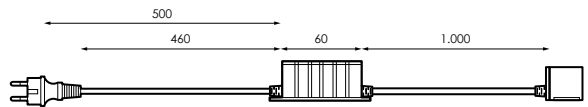

445627



230Vac/dc Max. 600W

IP44 Plug  
IP66 Conector

### EMPALME L NEON

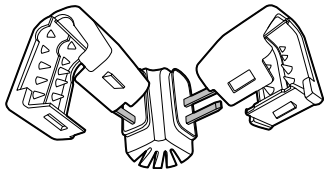

445641

T Transparente

### EMPALME SENCILLO NEON

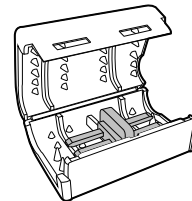

445634

T Transparente

### TAPA FINAL NEON

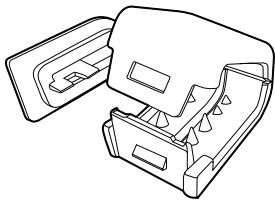

445658

T Transparente

### CLIP SUJECCIÓN NEON

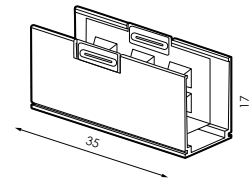

445672

A Aluminio

### CANAleta NEON

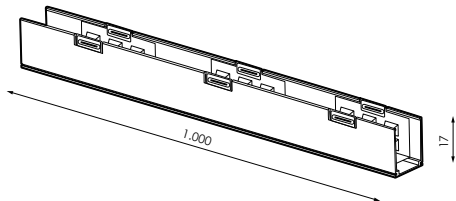

445665

A Aluminio

### PEGAMENTO NEON

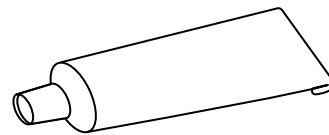

445689

### CABLE ALIMENTACIÓN MAXIBRILLO

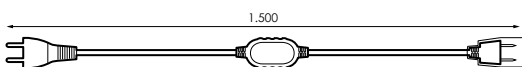

210713



230Vac Max. 480W

IP44 Plug  
IP65 Conector

### CONECTOR L MAXIBRILLO

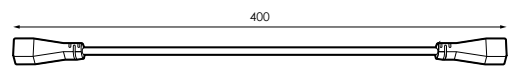

210751

BI Blanco

### CLIP SUJECCIÓN MAXIBRILLO

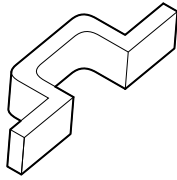

210768



**T** Transparente

### EMPALME ESTANCO MAXIBRILLO

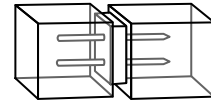

210744



**T** Transparente

### CONECTOR MACHO MAXIBRILLO

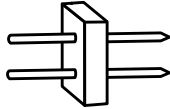

383929



**T** Transparente

### TAPA FINAL MAXIBRILLO

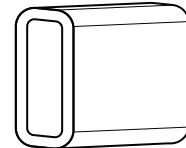

210737



**T** Transparente

### CABLE ALIMENTACIÓN BRITE

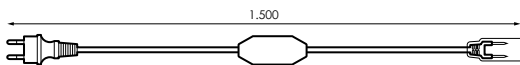

442701



230Vac



Max. 480W



IP44 Plug  
IP66 Conector

### EXTENSIÓN BRITE

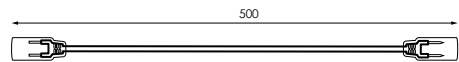

442787



**BI** Blanco

### ADAPTADOR SMART LINK-FLEXILIGHT BRITE

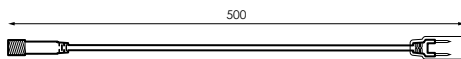

442800



**BI** Blanco

### ADAPTADOR FLEXILIGHT BRITE-SMART LINK

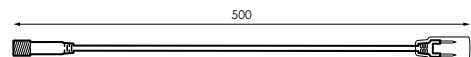

442817



**BI** Blanco

### CONECTOR L BRITE

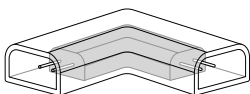

442763



**T** Transparente

### CONECTOR X BRITE

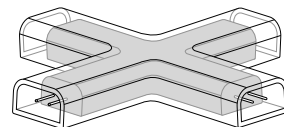

442770



**T** Transparente

### EMPALME BRITE

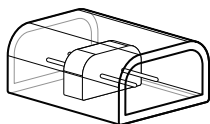

442732



T Transparente

### EMPALME SENCILLO BRITE

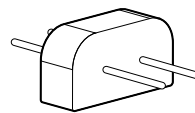

442725



T Transparente

### CONECTOR MACHO BRITE

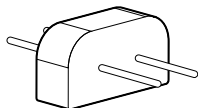

442718



T Transparente

### CLIP SUJECCIÓN BRITE

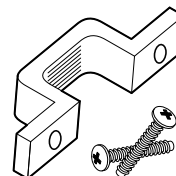

442749



T Transparente

### TAPA FINAL BRITE

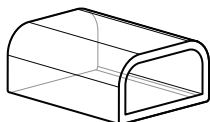

442794



T Transparente

### CANALETA BRITE



442756



1m



T Transparente

***minimalist***

---



# STRING PLUS 100

## EXTERIOR

SMART LINK 





Los Silos - Santa Cruz de Tenerife

 230V dc

 CII































 1 CANAL

 IP65

 -20°C~+60 °C

 NO INC.



				<b>10m</b> (5m x 2seg)
546690				5m
546706				100
546713				50
546720				8W
546737				4W
546744				100m
546751				
546768				
546775				
546782				

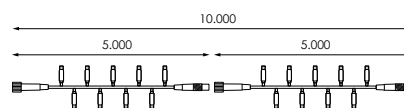

ESQUEMA INSTALACIÓN/  
INSTALLATION SCHEME/  
SCHEMA D'INSTALLATION/  
ESQUEMA DE INSTALAÇÃO



+

Producto/Product  
Produit/Produto

Accesorios/Accessories/Accessoires/Acessórios + INFO PAG. 302



995092

Cable alimentación Negro

977722







Cable alimentación Blanco



# STRING **PLUS** 100 Flashing

## EXTERIOR

SMART  
LINK 

	230V dc
	CII
	1 CANAL
	IP65
	-20°C~+60 °C
	NO INC.



Los Silos -  
Santa Cruz de Tenerife

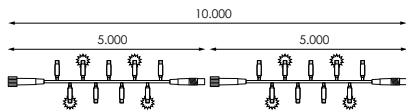



















ESQUEMA INSTALACIÓN/  
INSTALLATION SCHEME/  
SCHEMA D'INSTALLATION/  
ESQUEMA DE INSTALAÇÃO



+

Producto/Product  
Produit/Produto

	<b>10m</b> (5m x 2seg)
	<b>5m</b>
	<b>100</b>
	<b>40+10</b> flashing
	<b>8W</b>
	<b>4W</b>
	<b>100m</b>

		
<b>546799</b>		
<b>546805</b>		
<b>546812</b>		
<b>546829</b>		



+ INFO PAG. 302 **Accesorios/Accessories/Accessoires/Acessórios**

**995092**

Cable alimentación Negro

**977722**

Cable alimentación Blanco

# SCREENLIGHT 100

## EXTERIOR

SMART  
LINK 



Cuidad de Braga 2020  
by AM Illumination  
Producto Prilux

 230V dc







 CII







 1 CANAL

 IP65

 -20°C~+60 °C

 NO INC.

		
503969		
503976		

	2x1m
	20
	2
	100
	5
<b>W</b>	7,7W
	10sets

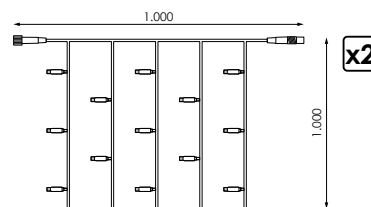

ESQUEMA INSTALACIÓN/  
INSTALLATION SCHEME/  
SCHÉMA D'INSTALLATION/  
ESQUEMA DE INSTALAÇÃO



+

Producto/Product  
Produit/Produto

Accesorios/Accessories/Accessoires/Acessórios + INFO PAG. 302



977722

Cable alimentación Blanco

# SCREENLIGHT 150

## EXTERIOR

SMART LINK

⚡ 230V dc

☐ CII

👁️ 1 CANAL

⊙ IP65

🌡️ -20°C~+60 °C

⊗ NO INC.

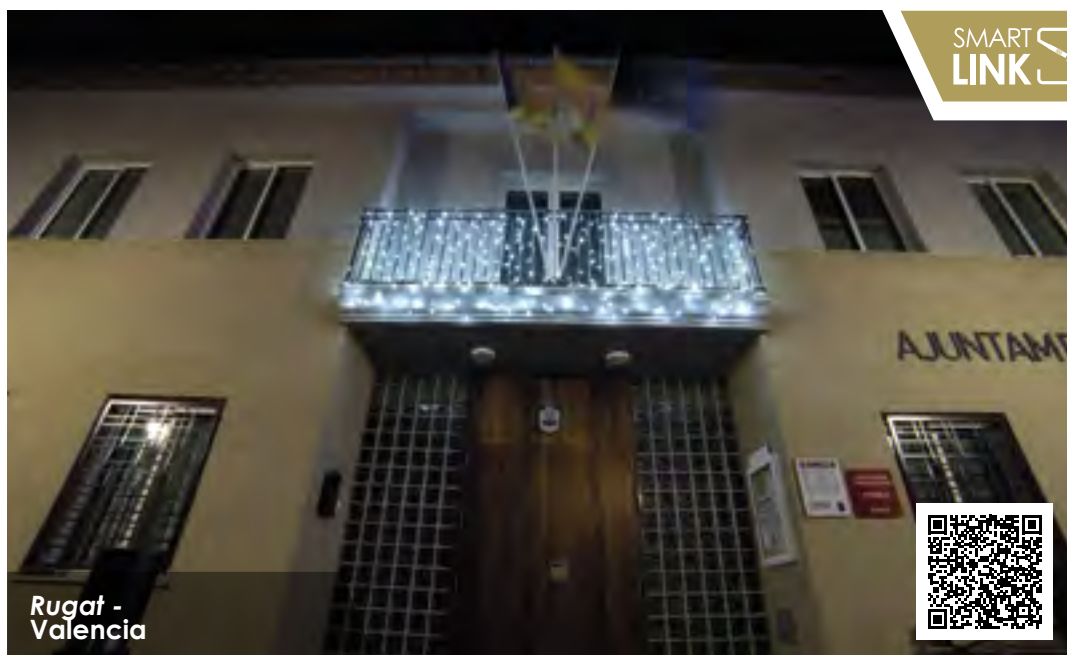

Rugat -  
Valencia

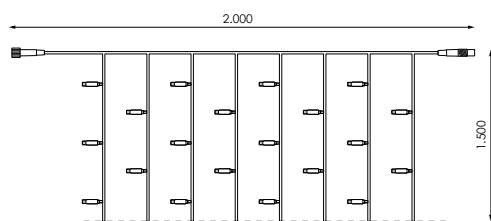

ESQUEMA INSTALACIÓN/  
INSTALLATION SCHEME/  
SCHEMA D'INSTALLATION/  
ESQUEMA DE INSTALAÇÃO



+

Producto/Product  
Produit/Produto



2x1,5m



20



150



7/8



12W



10sets



546850



LED

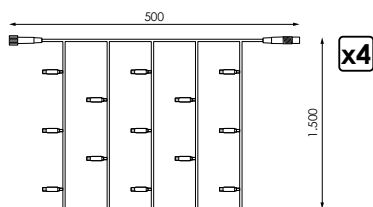

ESQUEMA INSTALACIÓN/  
INSTALLATION SCHEME/  
SCHEMA D'INSTALLATION/  
ESQUEMA DE INSTALAÇÃO



+

Producto/Product  
Produit/Produto



2x1,5m



20



4



150



7/8



15W



10sets



503990



LED



504003

LED



+ INFO PAG. 302

Accesorios/Accessories/Accessoires/Acessórios

977722

Cable alimentación Blanco

# SCREENLIGHT 300

## EXTERIOR

**N** Nuevo  
New  
Nouveau  
Novo

SMART  
LINK 

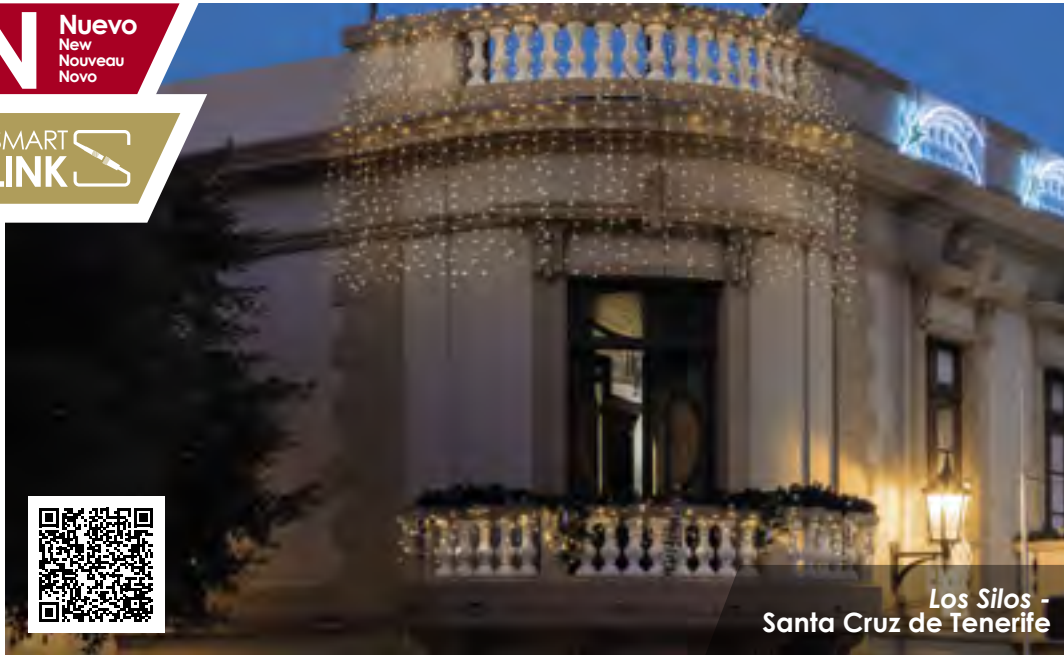

Los Silos -  
Santa Cruz de Tenerife

 230V dc





 CII





 1 CANAL

 IP65

 -20°C~+60 °C

 NO INC.

		
546881		

	2x3m
	20
	300
	15
<b>W</b>	20W
	7sets

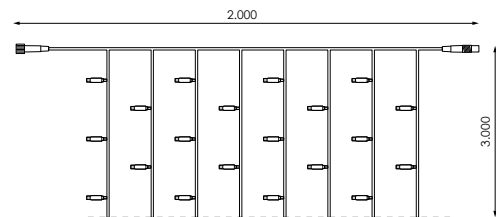













ESQUEMA INSTALACIÓN/  
INSTALLATION SCHEME/  
SCHÉMA D'INSTALLATION/  
ESQUEMA DE INSTALAÇÃO



+

Producto/Product  
Produit/Produto

		
504010		
 561471		

	2x3m
	20
<b>Nº</b>	4
	300
	15
<b>W</b>	18,4W
	7sets

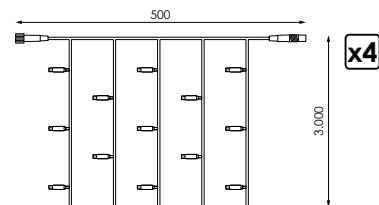

ESQUEMA INSTALACIÓN/  
INSTALLATION SCHEME/  
SCHÉMA D'INSTALLATION/  
ESQUEMA DE INSTALAÇÃO



+

Producto/Product  
Produit/Produto

Accesorios/Accessories/Accessoires/Acessórios + INFO PAG. 302









977722

Cable alimentación Blanco

# SCREENLIGHT 600

## EXTERIOR

	230V dc
	CII
	1 CANAL
	IP65
	-20°C~+60 °C
	NO INC.



Nuevo  
New  
Nouveau  
Novo

SMART  
LINK

CC Parque Corredor -  
Alcalá de Henares (Madrid)

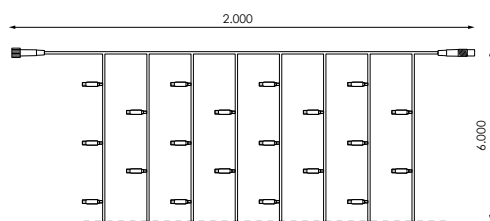

ESQUEMA INSTALACIÓN/  
INSTALLATION SCHEME/  
SCHEMA D'INSTALLATION/  
ESQUEMA DE INSTALAÇÃO



+

Producto/Product  
Produit/Produto



2x6m



20



600



30



35W



3sets



546898



LED



LED

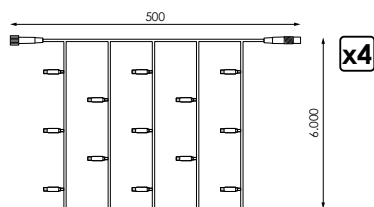

ESQUEMA INSTALACIÓN/  
INSTALLATION SCHEME/  
SCHEMA D'INSTALLATION/  
ESQUEMA DE INSTALAÇÃO



+

Producto/Product  
Produit/Produto



2x6m



20



4



600



30



42W



3sets



530347



LED



LED



+ INFO PAG. 302

Accesorios/Accessories/Accessoires/Acessórios

977722

Cable alimentación Blanco

# SCREENLIGHT 900

## EXTERIOR

SMART  
LINK 



CC. Malleria Plaza - Latacunga (Ecuador)

 230V dc







 CII







 1 CANAL

 IP65

 -20°C~+60 °C

 NO INC.

		
504027		
504034		

	2x9m
	20
	4
	900
	45
<b>W</b>	70W
	<b>NO Empalmable</b>

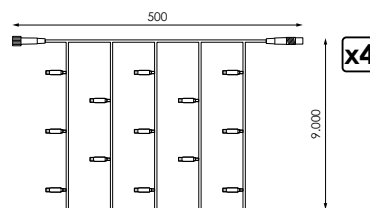

ESQUEMA INSTALACIÓN/  
INSTALLATION SCHEME/  
SCHEMA D'INSTALLATION/  
ESQUEMA DE INSTALAÇÃO



+

Producto/Product  
Produit/Produto

Accesorios/Accessories/Accessoires/Acessórios + INFO PAG. 302









977722

Cable alimentación Blanco

# SCREENLIGHT 150 Flashing

EXTERIOR

	230V dc
	CII
	1 CANAL
	IP65
	-20°C~+60 °C
	NO INC.



SMART LINK 

Cortijo MBI - Sevilla

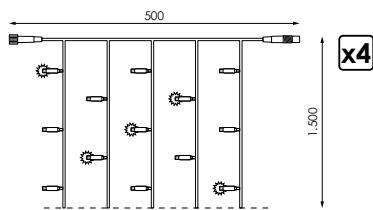















ESQUEMA INSTALACIÓN/  
INSTALLATION SCHEME/  
SCHEMA D'INSTALLATION/  
ESQUEMA DE INSTALAÇÃO



+

Producto/Product  
Produit/Produto

	2x1,5m
	20
	4
	150
	5+2 flashing /6+2 flashing
	15W
	10sets

		
504096		
504102		



+ INFO PAG. 302

Accesorios/Accessories/Accessoires/Acessórios

977722

Cable alimentación Blanco

# SCREENLIGHT 300 Flashing

## EXTERIOR

SMART  
LINK 



CC. Nervión Plaza - Sevilla

 230V dc





 CII





 1 CANAL

 IP65

 -20°C~+60 °C

 NO INC.

		
546942		

	2x3m
	20
	300
	12+3 flashing
<b>W</b>	20W
	7sets

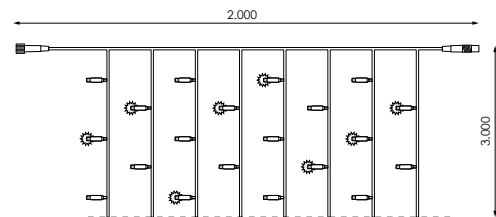













ESQUEMA INSTALACIÓN/  
INSTALLATION SCHEME/  
SCHÉMA D'INSTALLATION/  
ESQUEMA DE INSTALAÇÃO



+

Producto/Product  
Produit/Produto

		
504119		
504126		

	2x3m
	20
	300
	12+3 flashing
<b>W</b>	18,4W
	7sets

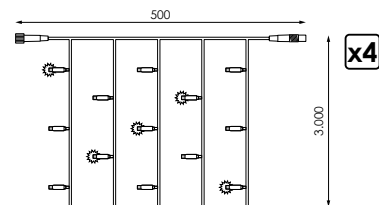

ESQUEMA INSTALACIÓN/  
INSTALLATION SCHEME/  
SCHÉMA D'INSTALLATION/  
ESQUEMA DE INSTALAÇÃO



+

Producto/Product  
Produit/Produto

Accesorios/Accessories/Accessoires/Acessórios + INFO PAG. 302









977722

Cable alimentación Blanco



# SCREENLIGHT 600 Flashing

EXTERIOR

	230V dc
	CII
	1 CANAL
	IP65
	-20°C~+60 °C
	NO INC.



SMART LINK 



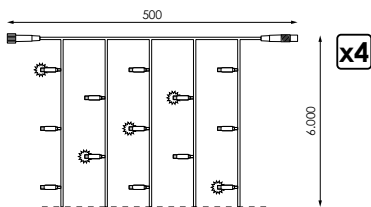



Canet de Berenguer - Valencia









ESQUEMA INSTALACIÓN/  
INSTALLATION SCHEME/  
SCHEMA D'INSTALLATION/  
ESQUEMA DE INSTALAÇÃO



+ Producto/Product  
Produit/Produto

	2x6m
	20
	4
	600
	24+6 flashing
	42W
	3sets

		
504140		
504157		



+ INFO PAG. 302

Accesorios/Accessories/Accessoires/Acessórios

977722

Cable alimentación Blanco

# SCREENLIGHT 900 Flashing

## EXTERIOR

SMART  
LINK 

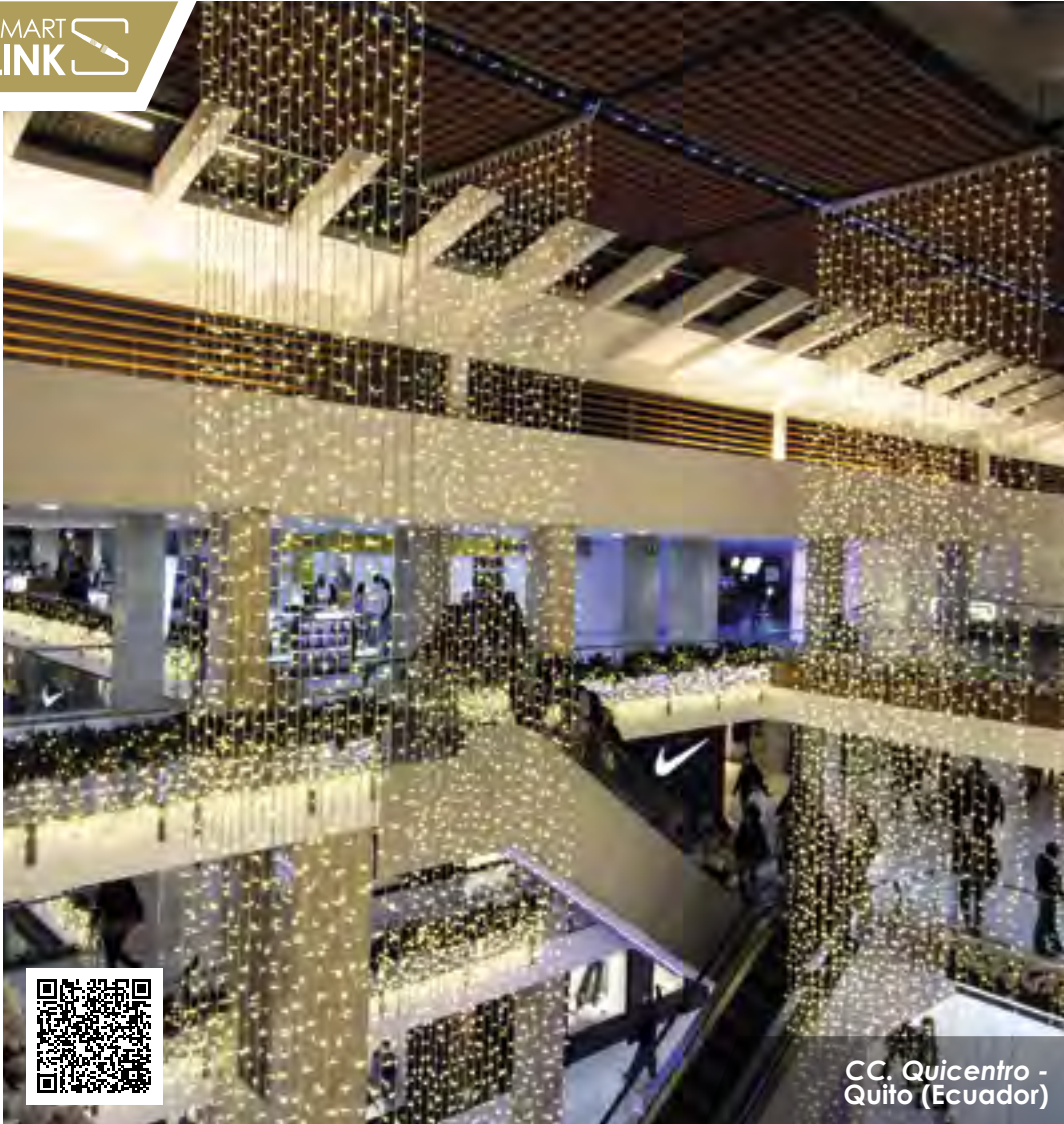

CC. Quicentro -  
Quito (Ecuador)

 230V dc

 CII







 1 CANAL







 IP65

 -20°C~+60 °C

 NO INC.



		
504041		
504058		

	2x9m
	20
	4
	900
	36+9 flashing
<b>W</b>	70W
	NO Empalmable

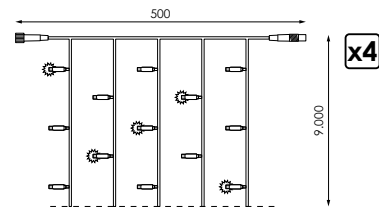

ESQUEMA INSTALACIÓN/  
INSTALLATION SCHEME/  
SCHEMA D'INSTALLATION/  
ESQUEMA DE INSTALAÇÃO



+

Producto/Product  
Produit/Produto

Accesorios/Accessories/Accessoires/Acessórios + INFO PAG. 302



977722

Cable alimentación Blanco









CC. Luz del Tajo - Toledo

# ICICLE<sup>®</sup> 102

## EXTERIOR







SMART  
LINK 









	230V dc
	CII
	1 CANAL
	IP65
	-20°C~+60 °C
	NO INC.



Los Silos -  
Santa Cruz de Tenerife

		
546973		
546980		

	<b>3x1m</b> (1,5m x 2seg)
	<b>2</b>
	<b>102</b>
	<b>51</b>
	<b>8W</b>
	<b>15sets</b>

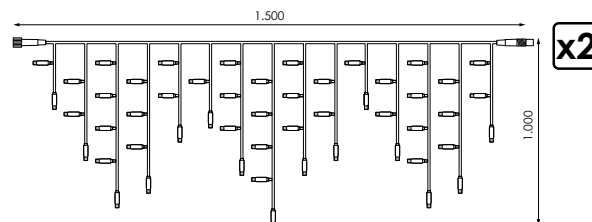

ESQUEMA INSTALACIÓN/  
INSTALLATION SCHEME/  
SCHEMA D'INSTALLATION/  
ESQUEMA DE INSTALAÇÃO



+

Producto/Product  
Produit/Produto

Accesorios/Accessories/Accessoires/Acessórios + INFO PAG. 302









977722

Cable alimentación Blanco

# ICICLE<sup>®</sup> 102 Flashing

## EXTERIOR

SMART  
LINK 

	230V dc
	CII
	1 CANAL
	IP65
	-20°C~+60 °C
	NO INC.



Noa Boutique Hotel -  
Santa Cruz (A Coruña)

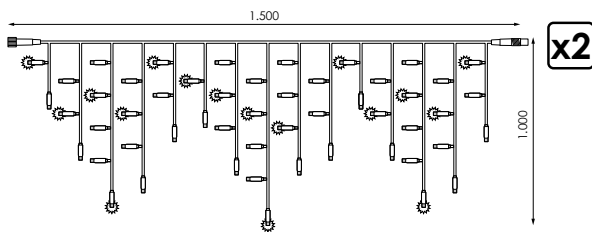













ESQUEMA INSTALACIÓN/  
INSTALLATION SCHEME/  
SCHEMA D'INSTALLATION/  
ESQUEMA DE INSTALAÇÃO



+

Producto/Product  
Produit/Produto

	3x1 m (1,5m x 2seg)
	2
	102
	42+9 flashing
	8W
	15sets

		
546997		
547000		



+ INFO PAG. 302

Accesorios/Accessories/Accessoires/Acessórios

977722

Cable alimentación Blanco

# STRING **PLUS** 100

INTERIOR

SMART  
LINK 



 230V dc







 CII





 1 CANAL

 IP20

 -20°C~+60 °C

 NO INC.

		
547017		
502030		

	12m (6m x 2seg)
	6m
	100
	50
<b>W</b>	8W
<b>W</b>	4W
	100m

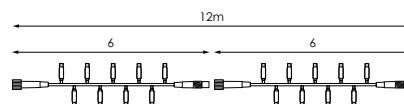

ESQUEMA INSTALACIÓN/  
INSTALLATION SCHEME/  
SCHEMA D'INSTALLATION/  
ESQUEMA DE INSTALAÇÃO



+

Producto/Product  
Produit/Produto

Accesorios/Accessories/Accessoires/Acessórios + INFO PAG. 302



192606

Cable alimentación Transparente



CC. ABC Serrano -  
Madrid

# SCREENLIGHT 100

## INTERIOR

SMART  
LINK 



 230V dc







 CII





 1 CANAL

 IP20

 -20°C~+60 °C

 NO INC.

		
547031		
547048		

	2x1m
	20
	100
	5
<b>W</b>	7,5W
	10sets

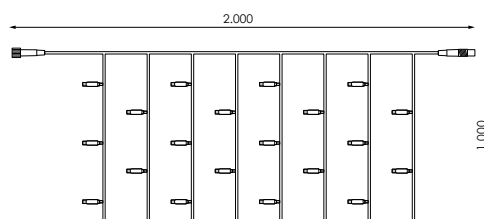











ESQUEMA INSTALACIÓN/  
INSTALLATION SCHEME/  
SCHÉMA D'INSTALLATION/  
ESQUEMA DE INSTALAÇÃO



+

Producto/Product  
Produit/Produto

		
504072		

	2x1m
	20
<b>Nº</b>	2
	100
	5
<b>W</b>	8W
	10sets

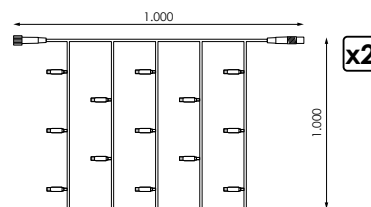

ESQUEMA INSTALACIÓN/  
INSTALLATION SCHEME/  
SCHÉMA D'INSTALLATION/  
ESQUEMA DE INSTALAÇÃO



+

Producto/Product  
Produit/Produto

Accesorios/Accessories/Accessoires/Acessórios + INFO PAG. 302









192606

Cable alimentación Transparente



# SCREENLIGHT 150

## INTERIOR

	230V dc
	CII
	1 CANAL
	IP20
	-20°C~+60 °C
	NO INC.

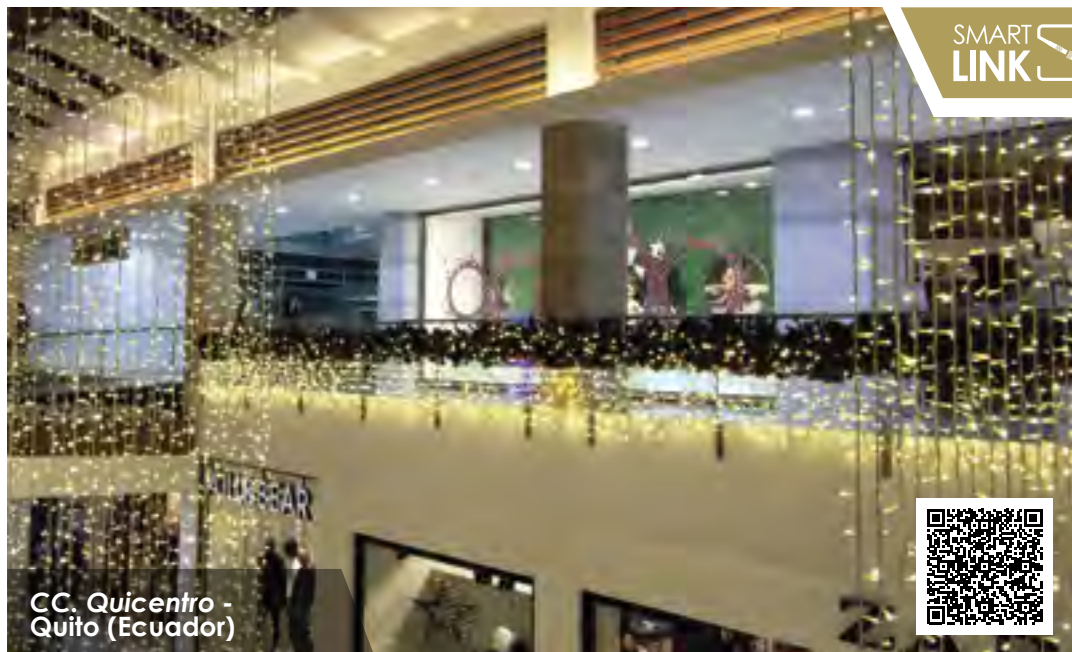

SMART LINK 

CC. Quicentro - Quito (Ecuador)

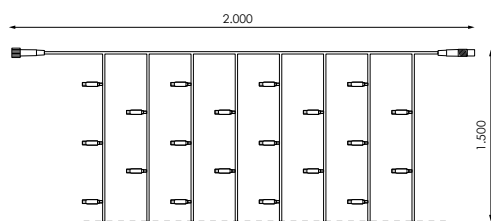













ESQUEMA INSTALACIÓN/  
INSTALLATION SCHEME/  
SCHEMA D'INSTALLATION/  
ESQUEMA DE INSTALAÇÃO



+

Producto/Product  
Produit/Produto

	2x1,5m
	20
	150
	7/8
<b>W</b>	12W
	10sets

		
547055		
547062		

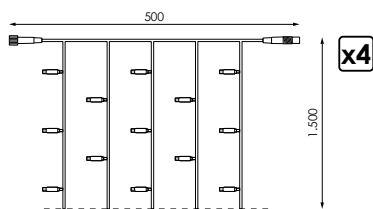











ESQUEMA INSTALACIÓN/  
INSTALLATION SCHEME/  
SCHEMA D'INSTALLATION/  
ESQUEMA DE INSTALAÇÃO



+

Producto/Product  
Produit/Produto

	2x1,5m
	20
	150
	7/8
<b>W</b>	15W
	10sets

		
504089		



+ INFO PAG. 302

Accesorios/Accessories/Accessoires/Acessórios

192606

Cable alimentación Transparente







# SCREENLIGHT 300







INTERIOR





SMART LINK 



CC. Metromar - Sevilla

	230V dc
	CII
	1 CANAL
	IP20
	-20°C~+60 °C
	NO INC.

		
547079		
547086		

	2x3m
	20
	300
	15
<b>W</b>	20W
	7sets

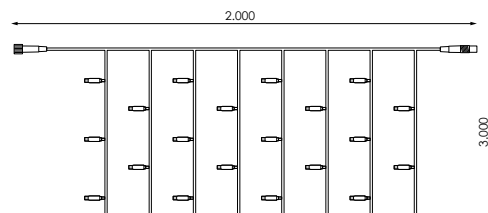

ESQUEMA INSTALACIÓN/  
INSTALLATION SCHEME/  
SCHEMA D'INSTALLATION/  
ESQUEMA DE INSTALAÇÃO



+

Producto/Product  
Produit/Produto

Accesorios/Accessories/Accessoires/Acessórios + INFO PAG. 302









192606

Cable alimentación Transparente

# SCREENLIGHT 600

INTERIOR

	230V dc
	CII
	1 CANAL
	IP20
	-20°C~+60 °C
	NO INC.

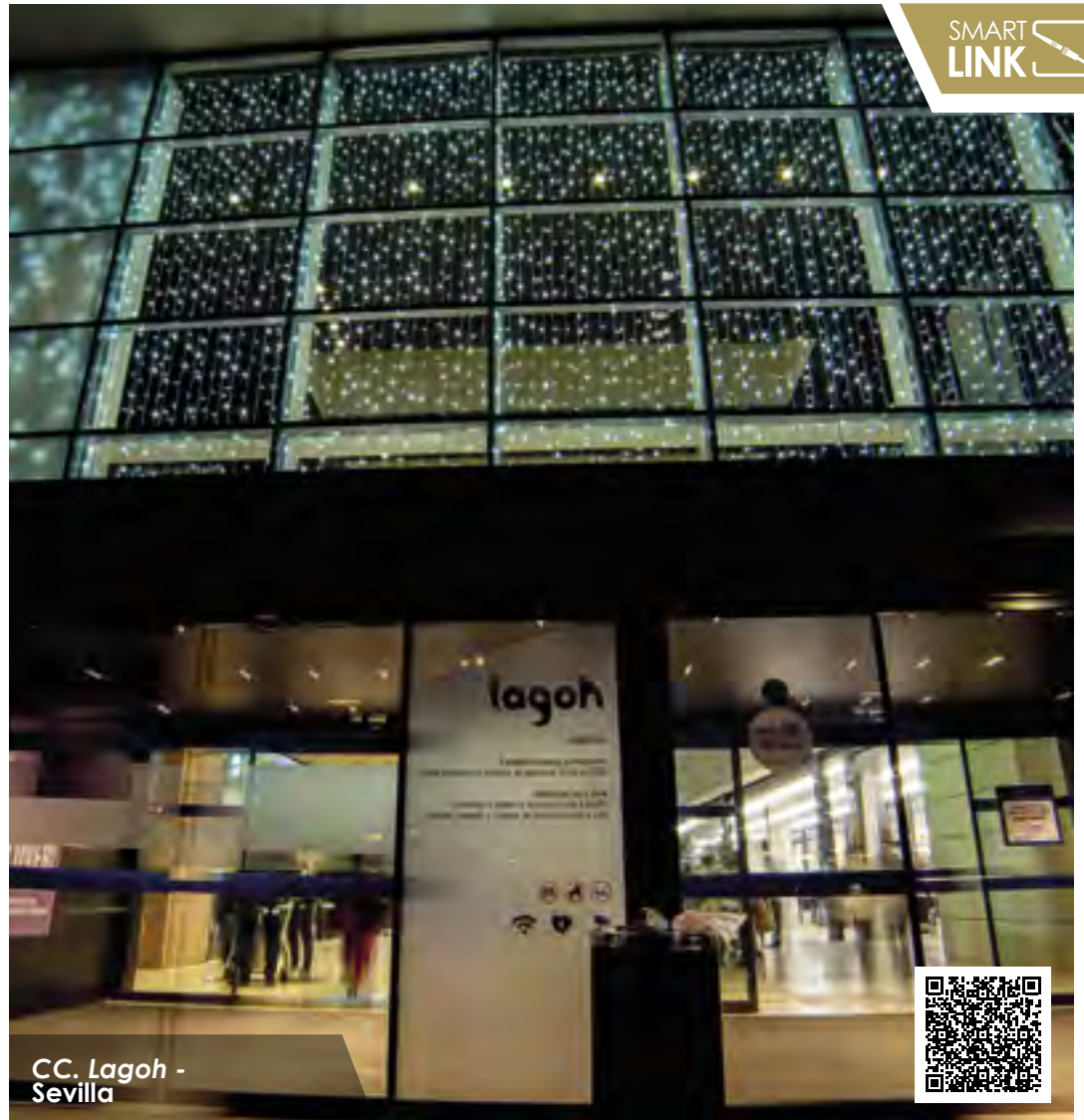

SMART LINK 

CC. Lagoh - Sevilla

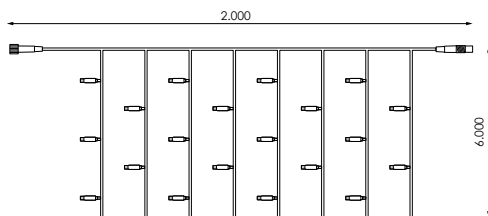













ESQUEMA INSTALACIÓN/  
INSTALLATION SCHEME/  
SCHEMA D'INSTALLATION/  
ESQUEMA DE INSTALAÇÃO



+

Producto/Product  
Produit/Produto

	2x6m
	20
	600
	30
<b>W</b>	35W
	3sets

		
547093		
547109		



+ INFO PAG. 302

Accesorios/Accessories/Accessoires/Acessórios

192606

Cable alimentación Transparente

# SCREENLIGHT 150 Flashing

## INTERIOR

SMART LINK 



 230V dc







 CII





 1 CANAL

 IP20

 -20°C~+60 °C

 NO INC.

		
547116		
547123		

	2x1,5m
	20
	150
	5+2 flashing /6+2 flashing
<b>W</b>	12W
	10sets

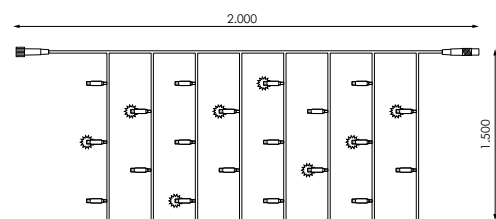

ESQUEMA INSTALACIÓN/  
INSTALLATION SCHEME/  
SCHÉMA D'INSTALLATION/  
ESQUEMA DE INSTALAÇÃO



+

Producto/Product  
Produit/Produto

Accesorios/Accessories/Accessoires/Acessórios + INFO PAG. 302



192606

Cable alimentación Transparente

# SCREENLIGHT 300 Flashing

INTERIOR



SMART LINK 

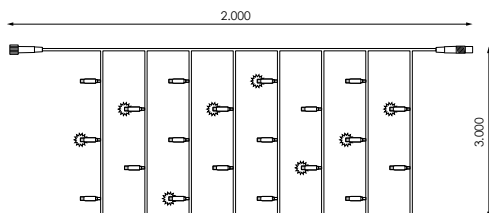













ESQUEMA INSTALACIÓN/  
INSTALLATION SCHEME/  
SCHEMA D'INSTALLATION/  
ESQUEMA DE INSTALAÇÃO



+

Producto/Product  
Produit/Produto

	2x3m
	20
	300
	12+3 flashing
<b>W</b>	20W
	7sets

		
547130		
547147		



+ INFO PAG. 302 **Accesorios/Accessories/Accessoires/Acessórios**

192606

Cable alimentación Transparente

# SCREENLIGHT 600 Flashing

INTERIOR



SMART LINK 

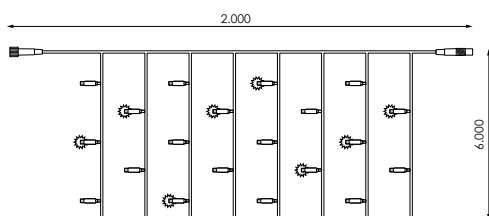













ESQUEMA INSTALACIÓN/  
INSTALLATION SCHEME/  
SCHEMA D'INSTALLATION/  
ESQUEMA DE INSTALAÇÃO



+

Producto/Product  
Produit/Produto

	2x6m
	20
	600
	24+6 flashing
<b>W</b>	35W
	3sets

		
547154		
547161		



+ INFO PAG. 302 **Accesorios/Accessories/Accessoires/Acessórios**

192606

Cable alimentación Transparente

# ICICLE<sup>®</sup> 102

## INTERIOR

SMART  
LINK 



CC. ABC Serrano - Madrid

 230V dc

 CII







 1 CANAL





 IP20

 -20°C~+60 °C

 NO INC.



		
547178		
547185		

	<b>3x1m</b> (1,5m x 2seg)
	<b>2</b>
	<b>102</b>
	<b>51</b>
<b>W</b>	<b>8W</b>
	<b>15sets</b>

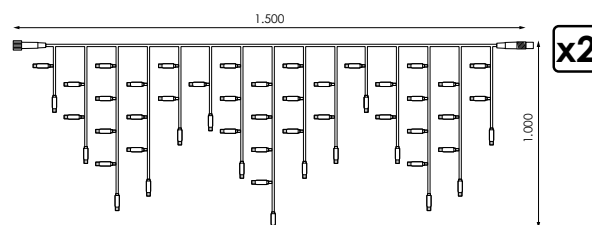

ESQUEMA INSTALACIÓN/  
INSTALLATION SCHEME/  
SCHEMA D'INSTALLATION/  
ESQUEMA DE INSTALAÇÃO



+

Producto/Product  
Produit/Produto

Accesorios/Accessories/Accessoires/Acessórios + INFO PAG. 302









192606

Cable alimentación Transparente

# ICICLE<sup>®</sup> 102 Flashing

## INTERIOR

SMART  
LINK 

	230V dc
	CII
	1 CANAL
	IP20
	-20°C~+60 °C
	NO INC.

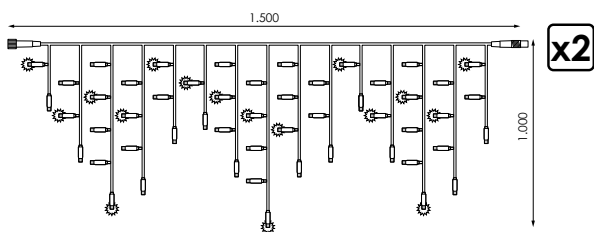
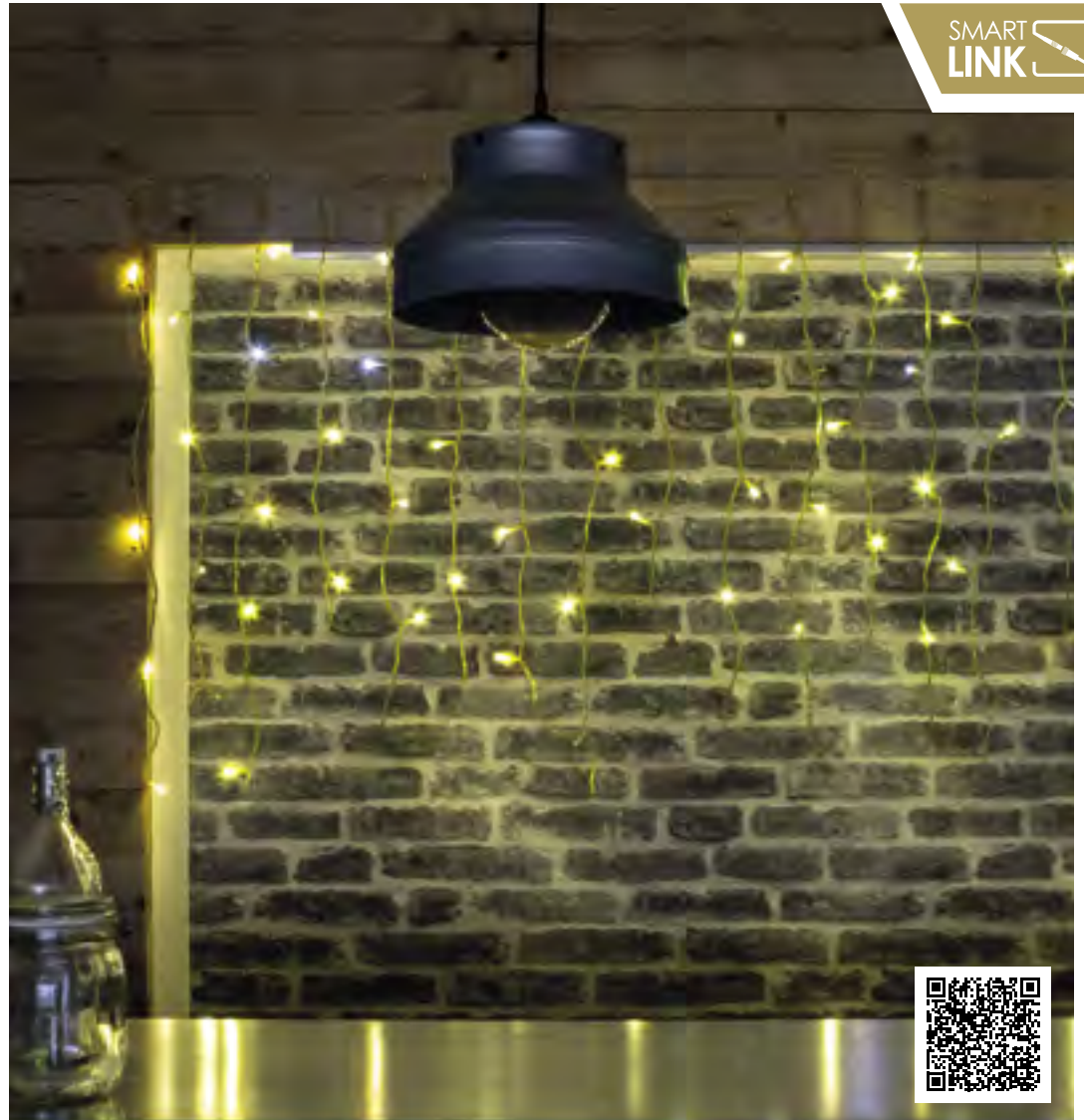













ESQUEMA INSTALACIÓN/  
INSTALLATION SCHEME/  
SCHEMA D'INSTALLATION/  
ESQUEMA DE INSTALAÇÃO



+

Producto/Product  
Produit/Produto

	3x1 m (1,5m x 2seg)
	2
	102
	42+9 flashing
	8W
	15sets

		
547192		
547208		



+ INFO PAG. 302 **Accesorios/Accessories/Accessoires/Acessórios**

192606

Cable alimentación Transparente

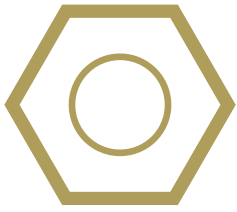

# Accesorios

Accessories  
Accessoires  
Acessórios

		STRING PLUS 100 exterior	STRING PLUS 100 FLASHING exterior	SCREENLIGHT exterior	SCREENLIGHT FLASHING exterior	ICICLE# 102 exterior	ICICLE# 102 FLASHING exterior	STRING PLUS 100 interior	SCREENLIGHT interior	SCREENLIGHT FLASHING interior	ICICLE# 102 interior	ICICLE# 102 FLASHING interior
⏏	192606							•	•	•	•	•
	977722	•	•	•	•	•	•					
	995092	•	•									
Ⓢ	192323	•	•	•	•	•	•					
	192347	•	•	•	•	•	•					
	192354	•	•	•	•	•	•					
	192361	•	•	•	•	•	•					
	192378	•	•	•	•	•	•					
	192385	•	•	•	•	•	•					
	192392	•	•	•	•	•	•					
	192408	•	•	•	•	•	•					
	192415	•	•	•	•	•	•					
	192422	•	•	•	•	•	•					
	192439	•	•	•	•	•	•					
	192446	•	•	•	•	•	•					
	388368	•	•	•	•	•	•					
	388375	•	•	•	•	•	•					
	388382	•	•	•	•	•	•					
	388399	•	•	•	•	•	•					
	388498	•	•	•	•	•	•					
	388504	•	•	•	•	•	•					
	391498	•	•	•	•	•	•					
	391504	•	•	•	•	•	•					

CABLE ALIMENTACIÓN SMART LINK exterior

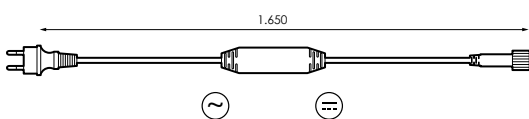

CABLE ALIMENTACIÓN SMART LINK interior

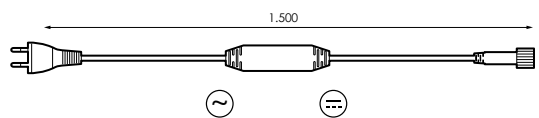

		⊗	⚡	W	□	⊕
995092	Ⓢ	230Vac	Max. 480W	CII	IP44 Plug IP65 Conector	
977722	Ⓢ	230Vac	Max. 480W	CII	IP44 Plug IP65 Conector	



		⊗	⚡	W	□	⊕
192606	Ⓢ	230Vac	Max. 480W	CII	IP20	



### CONECTOR T SMART LINK

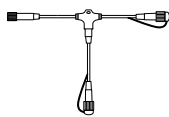

192446



IP65

192439



IP65

### CONECTOR X SMART LINK

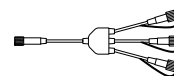

391504



IP65

391498



IP65

### CONECTOR 5 SMART LINK

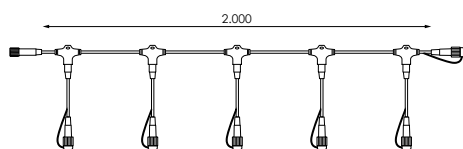

388375

2m

5



IP65

388368

2m

5



IP65

### CONECTOR 10 SMART LINK

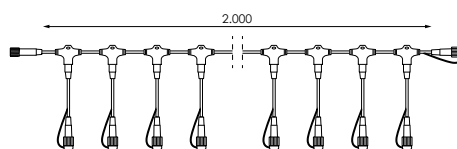

388399

2m

10



IP65

388382

2m

10



IP65

### CONECTOR 10 SMART LINK

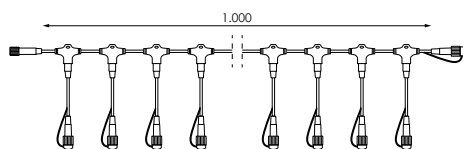

192408

1m

10



IP65

192392

1m

10



IP65

### CONECTOR 20 SMART LINK

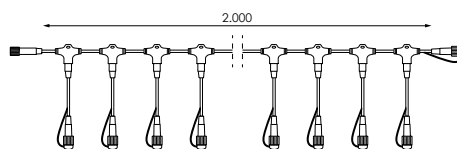

192422

2m

20



IP65

192415

2m

20



IP65

### EXTENSIÓN SMART LINK

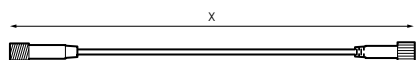

388498

0,5m



IP65

388504

0,5m



IP65

192347

1m



IP65

192323

1m



IP65

192361

3m



IP65

192354

3m



IP65

192385

5m



IP65

192378

5m



IP65

# **Led Exterior**

---

Outdoors Led  
Led à l'extérieur  
Led ao ar livre

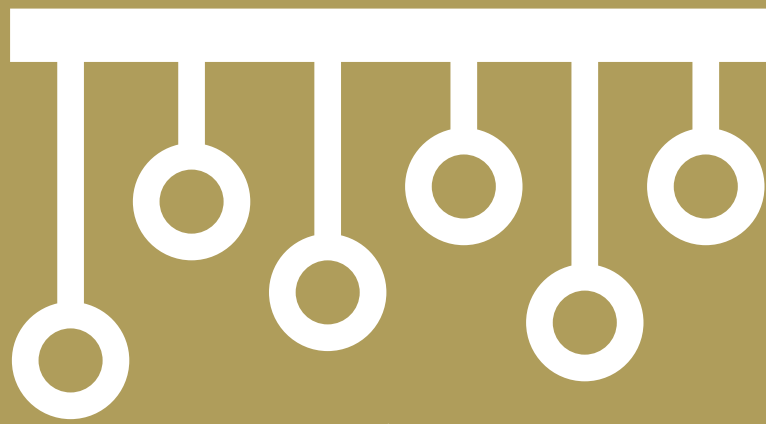

# String AVANT 180

IP67

SMART LINK  
AVANT



Villanueva de Gallego - Zaragoza

230V dc

CII

1 CANAL

IP67

-20°C~+60 °C

NO INC.

486941		
486958		
486965		
486972		
486989		
486996		
487009		
487016		
487023		
487030		

	12m (4m x 3seg)
	4m
	180
	60
	10W
	3W
	100m

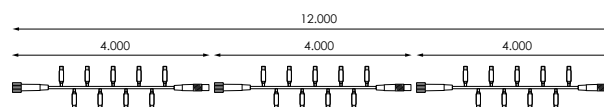

ESQUEMA INSTALACIÓN/  
INSTALLATION SCHEME/  
SCHEMA D'INSTALLATION/  
ESQUEMA DE INSTALAÇÃO



+

Producto/Product  
Produit/Produto

Accesorios/Accessories/Accessoires/Acessórios + INFO PAG. 352



487207

Cable alimentación Negro

487214

Cable alimentación Blanco

# String AVANT 180

## IP67 FLASHING

SMART LINK  
AVANT

⚡ 230V dc

□ CII

👁️ 1 CANAL

🌧️ IP67

🌡️ -20°C~+60 °C

⚡ NO INC.



Galdar -  
Canarias

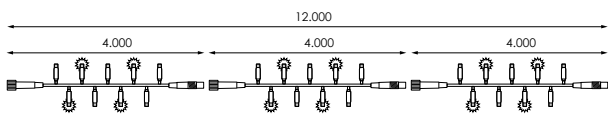

ESQUEMA INSTALACIÓN/  
INSTALLATION SCHEME/  
SCHEMA D'INSTALLATION/  
ESQUEMA DE INSTALAÇÃO



+

Producto/Product  
Produit/Produto



12m  
(4m x 3seg)



4m



180



50+10  
flashing



10W



3W



100m



486873



486880



486859



486866



486897



486903



486910



486927



486934



+ INFO PAG. 352

Accesorios/Accessories/Accessoires/Acessórios

487207

Cable alimentación Negro

487214

Cable alimentación Blanco

# STRING **PLUS** 180

## 24V FUENTE ALIMENTACIÓN



Escatrón - Zaragoza

	24V dc
	CIII
	1 CANAL
	IP65
	-20°C~+60 °C
	NO INC.

			W
149174			8W
146449			8,5W
505567			7W
505574			8,5W
191982			5,5W
441865			6,5W
477925			8,5W
441896			8,5W
441872			8,5W
441889			8,5W

	12m (4m x 3seg)
	4m
	180
	60
	*Accesorios

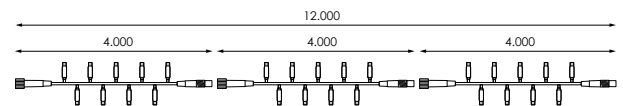

ESQUEMA INSTALACIÓN/  
INSTALLATION SCHEME/  
SCHEMA D'INSTALLATION/  
ESQUEMA DE INSTALAÇÃO



### Aviso/Warning/Avertissement/Aviso



Ñ/ Uso **OBLIGATORIO** de fuente de alimentación.

E/ You **MUST USE** the power supply.

F/ L'utilisation **OBLIGATOIRE** de l'alimentation

P/ Uso **OBRIGATÓRIO** fonte de alimentação.

### Accesorios/Accessories/Accessoires/Acessórios + INFO PAG. 352



Ñ/ Fuente de alimentación **NO INCLUIDA**

E/ Power supply **NOT INCLUDED**

F/ Alimentation **NON INCLUSE**

P/ Fonte de alimentação **NÃO INCLUÍDO**

<b>488440</b>	Fuente alimentación 30W 24V
<b>488464</b>	Fuente alimentación 100W 24V
<b>481694</b>	Fuente alimentación 200W 24V

<b>488457</b>	Fuente alimentación 60W 24V
<b>481687</b>	Fuente alimentación 150W 24V

<b>488440</b>	48m
<b>488457</b>	100m paralelo 48m en serie
<b>488464</b>	168m paralelo 48m en serie
<b>481687</b>	252m paralelo 48m en serie
<b>481694</b>	340m paralelo 48m en serie

# STRING **PLUS** 180

## 24V FLASHING FUENTE ALIMENTACIÓN

	24V dc
	CIII
	1 CANAL
	IP65
	-20°C~+60 °C
	NO INC.



**N**  
Nuevo  
New  
Nouveau  
Novo

Arcos Valdevez - Portugal

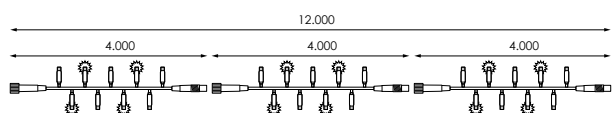

ESQUEMA INSTALACIÓN/  
INSTALLATION SCHEME/  
SCHEMA D'INSTALLATION/  
ESQUEMA DE INSTALAÇÃO



+

Producto/Product  
Produit/Produto

	<b>12m</b> (4m x 3seg)
	<b>4m</b>
	<b>180</b>
	<b>50+10</b> flashing
	<b>8,5W</b>
	<b>*Accesorios</b>

<b>413732</b>		
<b>413749</b>		
<b>505598</b>		
<b>505604</b>		
<b>(N) 561488</b>		
<b>(N) 561495</b>		
<b>(N) 561501</b>		
<b>542296</b>		
<b>505628</b>		
<b>505611</b>		

### **Aviso/Warning/Avertissement/Aviso**

**Ñ/** Uso **OBLIGATORIO** de fuente de alimentación.

**E/** You **MUST USE** the power supply.

**F/** L'utilisation **OBLIGATOIRE** de l'alimentation

**P/** Uso **OBRIGATÓRIO** fonte de alimentação.

### + INFO PAG. 352 **Accesorios/Accessories/Accessoires/Acessórios**

**Ñ/** Fuente de alimentación **NO INCLUIDA**

**E/** Power supply **NOT INCLUDED**

**F/** Alimentation **NON INCLUSE**

**P/** Fonte de alimentação **NÃO INCLUÍDO**

<b>488440</b>	<b>488457</b>		
Fuente alimentación 30W 24V	Fuente alimentación 60W 24V	<b>488440</b>	48m
<b>488464</b>	<b>481687</b>	<b>488457</b>	100m paralelo 48m en serie
Fuente alimentación 100W 24V	Fuente alimentación 150W 24V	<b>488464</b>	168m paralelo 48m en serie
<b>481694</b>		<b>481687</b>	252m paralelo 48m en serie
Fuente alimentación 200W 24V		<b>481694</b>	340m paralelo 48m en serie

# STRING **PLUS** 180

## 24V TRANSFORMADOR



Brenes -  
Sevilla



24V dc

CIII

1 CANAL

IP44

-20°C~+60 °C

NO INC.

NO INC.

191968		
191975		
191999		
542258		
542265		
542289		
542234		
542241		
542302		
542319		
542326		

	12m (4m x 3seg)
	4m
	180
	60
	50+10 flashing
	9W
	3W
	*Accesorios

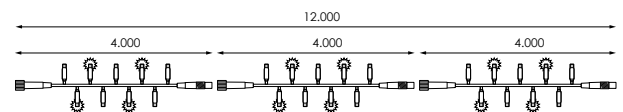
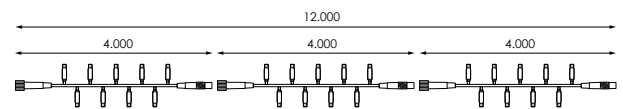

ESQUEMA INSTALACIÓN/  
INSTALLATION SCHEME/  
SCHEMA D'INSTALLATION/  
ESQUEMA DE INSTALAÇÃO



### Aviso/Warning/Avertissement/Aviso



**N/** Uso **OBLIGATORIO** de transformador y rectificador.  
El transformador de 10,8W (149181), de 28,8W (149198) y de 60W (149204) se utilizarán con el rectificador máx. 60W (150323). El transformador de 120W (149211) se utilizará con el rectificador máx. 96W (364478).

**E/** You **MUST USE** the transformer and rectifier.  
The 10.8W, 28.8W and 60W transformers (149181/149198/149204) will be used with the rectifier 60W maximum (150323). The 120W transformer (149211) will be used with the rectifier 96W maximum (364478).

**F/** L'utilisation **OBLIGATOIRE** du transformateur et redresseur.  
Les transformateurs de 10.8W, 28.8W et 60W (149181/149198/149204) seront utilisés avec redresseur 60W au maximum (150323). Le transformateur de 120W (149211) est utilisé avec le redresseur 96W maximale (364478).

**P/** Uso **OBRIGATÓRIO** de transformador e rectificador.  
Os transformadores de 10.8W, 28.8W e 60W (149181/149198/149204) serão usados com o retificador 60W máximo (150323). O transformador de 120W (149211) será usado com o retificador máximo 96W (364478).

### Accesorios/Accessories/Accessoires/Acessórios + INFO PAG. 352



**N/** Transformador y rectificador **NO INCLUIDO**

**E/** Transformer and rectifier **NOT INCLUDED**

**F/** Transformateur et redresseur **NON INCLUS**

**P/** Transformador e rectificador **NÃO INCLUIDO**

149181	Transformador 10,8W
149204	Transformador 60W
150323	Rectificador máx. 60W

149198	Transformador 28,8W
149211	Transformador 120W
364478	Rectificador máx. 96W

149181	12m
149198	36m
149204	80m paralelo 48m en serie
149211	160m paralelo 48m en serie



# STRING **PLUS** 180

## 1 SECCIÓN

SMART LINK 

 230V dc

 CII

 1 CANAL

 IP65

 -20°C~+60 °C

 NO INC.

**Ñ**/ \*120LEDs / 12m / 2 Segmentos de 6m / Con cable de alimentación  
**E**/ \*120LEDs / 12m / 2 Segments of 6m / With power cable **F**/ \*120LEDs / 12m / 2 Segments de 6m / Avec câble d'alimentation  
**P**/ \*120LEDs / 12m / 2 Segmentos de 6m / Com cabo de alimentação



Ciudad de Braga 2020  
 by AM Illumination  
 Producto Prilux

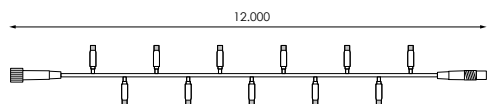

ESQUEMA INSTALACIÓN/  
 INSTALLATION SCHEME/  
 SCHEMA D'INSTALLATION/  
 ESQUEMA DE INSTALAÇÃO



Producto/Product  
 Produit/Produto

 12m

 12m

 180

 10W

 100m

960847   

388108   

960786   

163538   

163521   

388139   

388146   

477994   

478021   

388115   

388122   

476010   

478014   

478007   

087773\*   

+ INFO PAG. 352 **Accesorios/Accessories/Accessoires/Acessórios**

**995092**

Cable alimentación Negro

**977722**

Cable alimentación Blanco

# STRING PLUS 180

## CÁPSULA CLARA

**N** Nuevo  
New  
Nouveau  
Novo

SMART  
LINK



CC Nervión Plaza -  
Sevilla

⚡ 230V dc

☐ CII

👁️ 1 CANAL

🌧️ IP65

🌡️ -20°C~+60 °C

✖️ NO INC.



Barcode	LED	Light Type	Color
995108	LED	👁️	👁️
163651	LED	👁️	👁️
995115	LED	👁️	👁️
995122	LED	👁️	👁️
546577	LED	👁️	👁️
546584	LED	👁️	👁️
163477	LED	👁️	👁️
477987	LED	👁️	👁️
477949	LED	👁️	👁️
163507	LED	👁️	👁️
163491	LED	👁️	👁️
542227	LED	👁️	👁️
🅓 530293	LED	👁️	👁️
163514	LED	👁️	👁️
477932	LED	👁️	👁️
388153	LED	👁️	👁️
388160	LED	👁️	👁️

↔️	12m (4m x 3seg)
⏏️	4m
💡	180
💡	60
W	10W
W	3W
🔌	100m

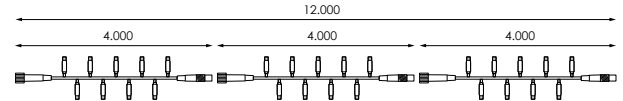

ESQUEMA INSTALACIÓN/  
INSTALLATION SCHEME/  
SCHEMA D'INSTALLATION/  
ESQUEMA DE INSTALACÃO



+

Producto/Product  
Produit/Produto

Accesorios/Accessories/Accessoires/Acessórios + INFO PAG. 352



995092  
Cable alimentación Negro

977722  
Cable alimentación Blanco

# STRING **PLUS** 180

## CÁPSULA MATE

	230V dc
	CII
	1 CANAL
	IP65
	-20°C~+60 °C
	NO INC.



SMART LINK

Palacio Episcopal - Segovia

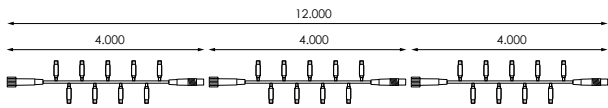

ESQUEMA INSTALACIÓN/  
INSTALLATION SCHEME/  
SCHEMA D'INSTALLATION/  
ESQUEMA DE INSTALAÇÃO



	<b>12m</b> (4m x 3seg)
	<b>4m</b>
	<b>180</b>
	<b>60</b>
	<b>10W</b>
	<b>3W</b>
	<b>100m</b>

Barcode	LED	Light	Smart Link
148894			
210775			
146227			
961165			
952361			
095587			
966450			
952392			
405829			
952378			
191951			
405836			
952385			
405843			
151122			
952408			
977241			

+ INFO PAG. 352 **Accesorios/Accessories/Accessoires/Acessórios**

**995092**

Cable alimentación Negro

**977722**

Cable alimentación Blanco

# STRING **PLUS** 120

ALL FLASHING

SMART  
LINK 



CC. Luz del Tajo -  
Toledo

 230V dc









 CII





 1 CANAL

 IP65

 -20°C~+60 °C

 NO INC.

		
977715	 	
995160	 	

	12m (4m x 3seg)
	4m
	120 flashing
	40 flashing
<b>W</b>	9W
<b>W</b>	3W
	100m

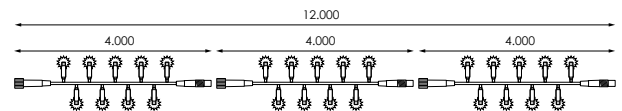

ESQUEMA INSTALACIÓN/  
INSTALLATION SCHEME/  
SCHEMA D'INSTALLATION/  
ESQUEMA DE INSTALAÇÃO



+

Producto/Product  
Produit/Produto

Accesorios/Accessories/Accessoires/Acessórios + INFO PAG. 352



995092

Cable alimentación Negro

977722

Cable alimentación Blanco

# STRING **PLUS** 180

## SPARKLE CÁPSULA CLARA

	230V dc
	CII
	1 CANAL
	IP65
	-20°C~+60 °C
	NO INC.

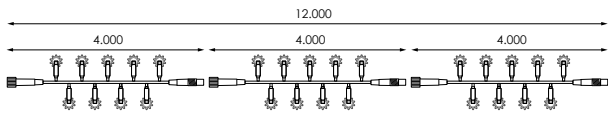

ESQUEMA INSTALACIÓN/  
INSTALLATION SCHEME/  
SCHEMA D'INSTALLATION/  
ESQUEMA DE INSTALAÇÃO



	<b>12m</b> (4m x 3seg)
	<b>4m</b>
	<b>180</b> sparkle
	<b>60</b> sparkle
	<b>10W</b>
	<b>3,5W</b>
	<b>100m</b>

Barcode	Lightbulb	Plug	Eye
512480*			
512442			
512459			
512466			
512473			
512497			
512503			
512510			
512527			
512541			
512893			



+ INFO PAG. 352 **Accesorios/Accessories/Accessoires/Acessórios**

**995092**

Cable alimentación Negro

**977722**

Cable alimentación Blanco



**Información/Information/Information/Informações**

Ñ/ \* Multicolor.

E/ \* Multicolored.

F/ \* Multicolore.

P/ \* Multicolorido.

# STRING PLUS 180

## FLASHING CÁPSULA CLARA

**N** Nuevo  
New  
Nouveau  
Novo

SMART  
LINK



CC. As Cancelas -  
Santiago de Compostela



⚡ 230V dc

□ CII

🗺️ 1 CANAL

🌧️ IP65

🌡️ -20°C~+60 °C

✖️ NO INC.

Barcode	LED	Light	Control
542357	LED	Light	Control
542364	LED	Light	Control
995146	LED	Light	Control
977647	LED	Light	Control
542388	LED	Light	Control
542395	LED	Light	Control
542371	LED	Light	Control
542401	LED	Light	Control
542418	LED	Light	Control
(N) 512886	LED	Light	Control

↔	12m (4m x 3seg)
S	4m
💡	180
💡	50+10 flashing
W	11W
W	3W
🔗	100m

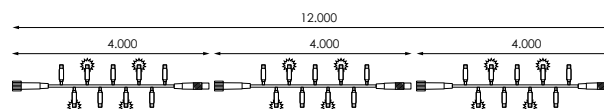

ESQUEMA INSTALACIÓN/  
INSTALLATION SCHEME/  
SCHEMA D'INSTALLATION/  
ESQUEMA DE INSTALAÇÃO



+

Producto/Product  
Produit/Produto

Accesorios/Accessories/Accessoires/Acessórios + INFO PAG. 352



995092

Cable alimentación Negro

977722

Cable alimentación Blanco

# STRING **PLUS** 180

## FLASHING CÁPSULA MATE

	230V dc
	CII
	1 CANAL
	IP65
	-20°C~+60 °C
	NO INC.

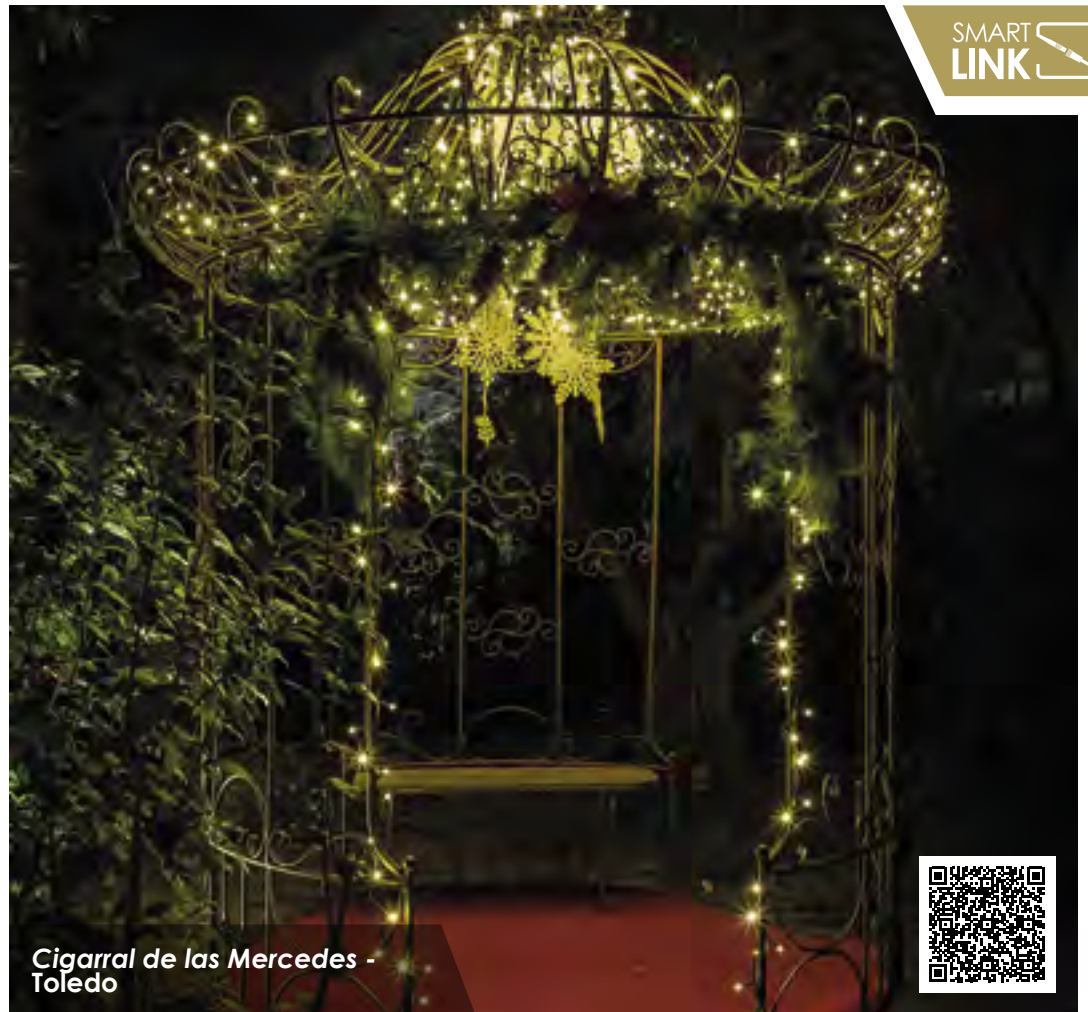

SMART  
LINK

Cigarral de las Mercedes - Toledo

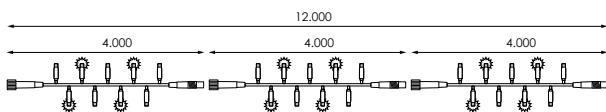

ESQUEMA INSTALACIÓN/  
INSTALLATION SCHEME/  
SCHEMA D'INSTALLATION/  
ESQUEMA DE INSTALAÇÃO



+

Producto/Product  
Produit/Produto

	<b>12m</b> (4m x 3seg)
	<b>4m</b>
	<b>180</b>
	<b>50+10</b> flashing
	<b>10W</b>
	<b>3W</b>
	<b>100m</b>

<b>146234</b>		
<b>977661</b>		
<b>977678</b>		
<b>977685</b>		
<b>388177</b>		
<b>388184</b>		



+ INFO PAG. 352 **Accesorios/Accessories/Accessoires/Acessórios**

**995092**

Cable alimentación Negro

**977722**

Cable alimentación Blanco

# Cluster Light

FALL LITE 1m

SMART LINK 



PRODUCTO



PROYECTO



CC. 7 Palmas -  
Las Palmas de Gran Canarias

 230V

 CII

 IP65

 -20°C~+60 °C

 NO INC.

 INC.



388191



388207



1m



6cm



50



1,5W



NO  
Empalmable

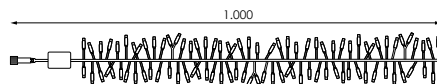

ESQUEMA INSTALACIÓN/  
INSTALLATION SCHEME/  
SCHÉMA D'INSTALLATION/  
ESQUEMA DE INSTALAÇÃO



+

Producto/Product  
Produit/Produto

Accesorios/Accessories/Accessoires/Acessórios + INFO PAG. 352



193061

Cable alimentación Negro

193078

Cable alimentación Blanco



# Cluster Light

## FALL LITE 3m

SMART LINK 

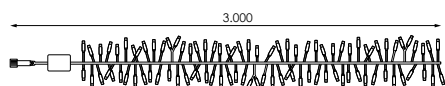

ESQUEMA INSTALACIÓN/  
INSTALLATION SCHEME/  
SCHEMA D'INSTALLATION/  
ESQUEMA DE INSTALAÇÃO



+

Producto/Product  
Produit/Produto



3m



6cm



150



3W



NO  
Empalnable



192057



388214



+ INFO PAG. 352 **Accesorios/Accessories/Accessoires/Acessórios**

193061

Cable alimentación Negro

193078

Cable alimentación Blanco

# Cluster Light

## FALL LITE 5m

SMART LINK 



ESQUEMA INSTALACIÓN/  
INSTALLATION SCHEME/  
SCHEMA D'INSTALLATION/  
ESQUEMA DE INSTALAÇÃO



+

Producto/Product  
Produit/Produto



5m



6cm



250



7W



NO  
Empalnable



192064



388221



+ INFO PAG. 352 **Accesorios/Accessories/Accessoires/Acessórios**

193061

Cable alimentación Negro

193078

Cable alimentación Blanco

# Cluster Light

## FLASHING

SMART LINK 



Gran Hotel Los Abetos -  
Santiago de Compostela

 230V dc

 CII

 IP65

 -20°C~+60 °C

 NO INC.



192026



192033



2m



160+40  
flashing



15W



7sets

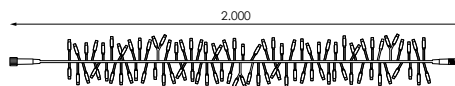

ESQUEMA INSTALACIÓN/  
INSTALLATION SCHEME/  
SCHÉMA D'INSTALLATION/  
ESQUEMA DE INSTALAÇÃO



+

Producto/Product  
Produit/Produto







Accesorios/Accessories/Accessoires/Acessórios + INFO PAG. 352



995092

Cable alimentación Negro

# Techo de Luz SCREENLIGHT FLASHING

	230V
	CII
	1 CANAL
	IP65
	-20°C~+60 °C
	NO INC.

**N**/ \*1 Led flashing cada 6 leds. **E**/ \*1 Led flashing each 6 leds. **F**/ \*1 Led clignotant chaque 6 leds. **P**/ \*1 Led piscando cada 6 leds.





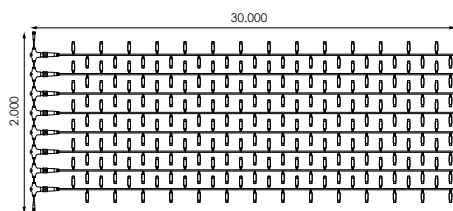

**Ciudad de Braga 2020**  
by AM Illumination  
Producto Prilux









ESQUEMA INSTALACIÓN/  
INSTALLATION SCHEME/  
SCHEMA D'INSTALLATION/  
ESQUEMA DE INSTALAÇÃO



Producto/Product  
Produit/Produto

	2x30m
	8
	792
	83+16 flashing
<b>W</b>	58W
	NO Empalmable

		
386128		
386135		



+ INFO PAG. 352 **Accesorios/Accessories/Accessoires/Acessórios**

995092

Cable alimentación Negro

# Techo de Luz



CC La Villa -  
La Orotava (Tenerife)

⚡ 12V

⚡ CIII

🎧 1 CANAL

🛡️ IP44

🏢 INC.



546621		
546614		

	2x30m
	7
	693
	99
<b>W</b>	115W
	<b>NO Empalmable</b>

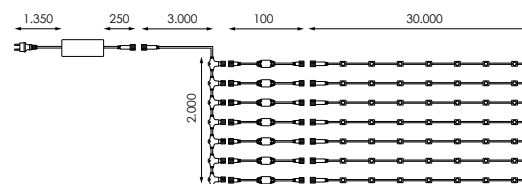

Accesorios/Accessories/Accessoires/Acessórios + INFO PAG. 352





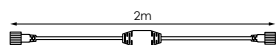

499507

Protector sobretensiones y termorretráctil



# Techo de Luz

## FLASHING









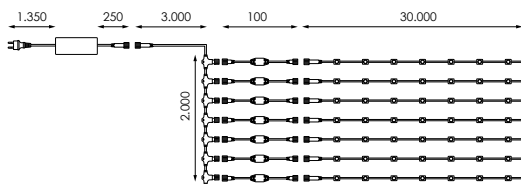



	12V
	CIII
	1 CANAL
	IP44
	INC.

Ñ/ \*1 Led flashing cada 9 leds. E/ \*1 Led flashing each 9 leds. F/ \*1 Led clignotant chaque 9 leds. P/ \*1 Led piscando cada 9 leds.



Torrijos - Toledo



	2x30m			
	7	391375		
	693	391382		
	88+11 flashing			
	115W			
	NO Empalmable			



+ INFO PAG. 352 **Accesorios/Accessories/Accessoires/Acessórios**

**499507**

Protector sobretensiones y termo-retráctil

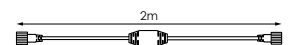

# SCREENLIGHT 300

24V



 24V dc









 CIII





 1 CANAL

 IP65

 -20°C~+60 °C

 NO INC.

		
192132	 	
192149	 	

	2x1,5m
	20
	300
	15
<b>W</b>	14,6W
	Máx. 5 sets en serie

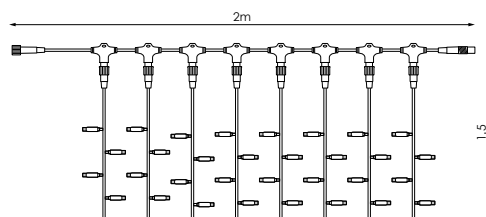

ESQUEMA INSTALACIÓN/  
INSTALLATION SCHEME/  
SCHEMA D'INSTALLATION/  
ESQUEMA DE INSTALAÇÃO



+

Producto/Product  
Produit/Produto

# SCREENLIGHT 600

24V



 24V dc









 CIII





 1 CANAL

 IP65

 -20°C~+60 °C

 NO INC.

		
192156	 	
192163	 	

	2x3m
	20
	600
	30
<b>W</b>	28,5W
	Máx. 4 sets en serie

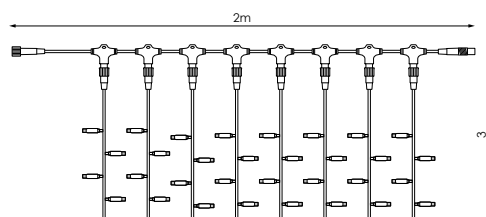

ESQUEMA INSTALACIÓN/  
INSTALLATION SCHEME/  
SCHEMA D'INSTALLATION/  
ESQUEMA DE INSTALAÇÃO



+

Producto/Product  
Produit/Produto



CC. Ferial Plaza - Guadalajara



Aviso/Warning/Avertissement/Aviso

Ñ/ Uso **OBLIGATORIO** de fuente de alimentación.

E/ You **MUST USE** the power supply.

F/ L'utilisation **OBLIGATOIRE** de l'alimentation

P/ Uso **OBRIGATÓRIO** fonte de alimentação.



+ INFO PAG. 352 **Accesorios/Accessories/Accessoires/Acessórios**

Ñ/ Fuente de alimentación **NO INCLUIDA**

**488440**

Fuente alimentación 30W 24V

E/ Power supply **NOT INCLUDED**

**488457**

Fuente alimentación 60W 24V

**488464**

Fuente alimentación 100W 24V

F/ Alimentation **NON INCLUSE**

**481687**

Fuente alimentación 150W 24V

**481694**

Fuente alimentación 200W 24V

P/ Fonte de alimentação **NÃO INCLuíDO**

# SCREENLIGHT 300

SMART LINK 



Calle Mayor, Molins - Orihuela (Alicante)



 230V dc















 CII





 1 CANAL

 IP65

 -20°C~+60 °C

 NO INC.

		
953108	 	
995177	 	
995184	 	
953115	 	

	2x1,5m
	20 (2 tiras = 1 serie)
	300
	15
<b>W</b>	30W
	10sets

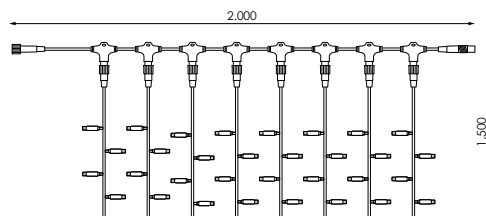

ESQUEMA INSTALACIÓN/  
INSTALLATION SCHEME/  
SCHÉMA D'INSTALLATION/  
ESQUEMA DE INSTALAÇÃO



Accesorios/Accessories/Accessoires/Acessórios + INFO PAG. 352



995092  
Cable alimentación Negro

977722  
Cable alimentación Blanco



# SCREENLIGHT 600

SMART  
LINK 

 230V dc

 CII

 1 CANAL

 IP65

 -20°C~+60 °C

 NO INC.



Clinica San Miguel -  
Pamplona

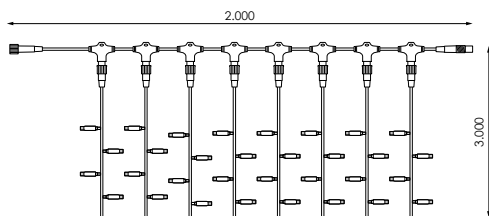

ESQUEMA INSTALACIÓN/  
INSTALLATION SCHEME/  
SCHEMA D'INSTALLATION/  
ESQUEMA DE INSTALAÇÃO



+ Producto/Product  
Produit/Produto



2x3m



20  
(2 tiras = 1 serie)



600



30



35W



7sets



953153



995191

995207

163712

+ INFO PAG. 352

Accesorios/Accessories/Accessoires/Acessórios

995092

Cable alimentación Negro

977722

Cable alimentación Blanco

# SCREENLIGHT 1200

SMART LINK 

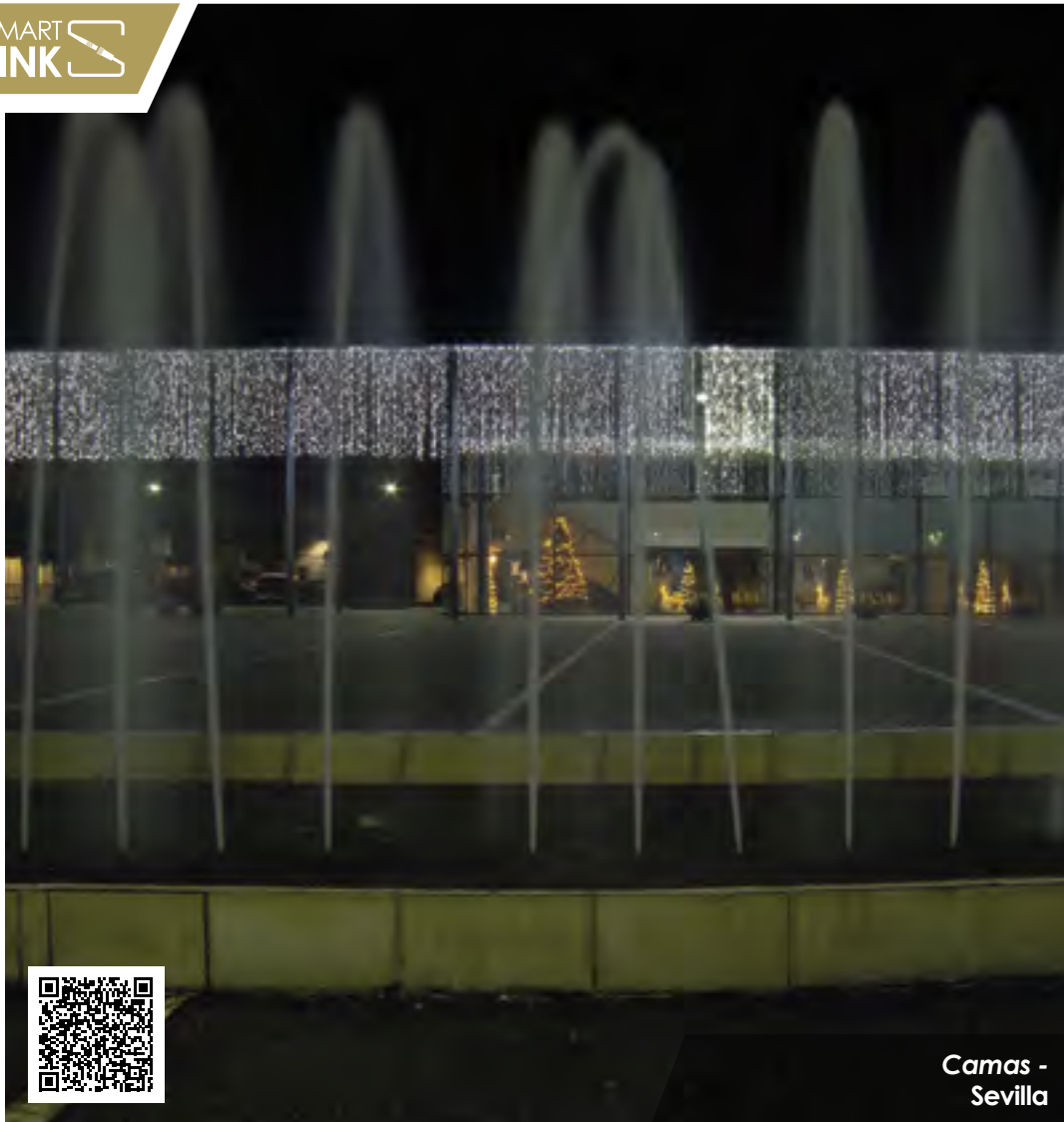

Camas -  
Sevilla

 230V dc















 CII





 1 CANAL

 IP65

 -20°C~+60 °C

 NO INC.

		
953177	 	
163569	 	
163576	 	
092609	 	

	2x6m
	20
	1200
	60
<b>W</b>	74W
	3sets

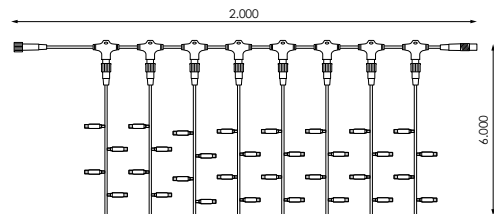

ESQUEMA INSTALACIÓN/  
INSTALLATION SCHEME/  
SCHÉMA D'INSTALLATION/  
ESQUEMA DE INSTALAÇÃO



+

Producto/Product  
Produit/Produto

Accesorios/Accessories/Accessoires/Acessórios + INFO PAG. 352



995092







Cable alimentación Negro

977722

Cable alimentación Blanco

# SCREENLIGHT 1800

SMART LINK 

	230V dc
	CII
	1 CANAL
	IP65
	-20°C~+60 °C
	NO INC.



CC. Espacio Torreloones - Madrid

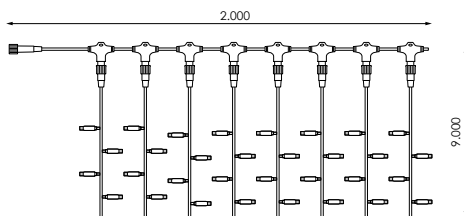













ESQUEMA INSTALACIÓN/  
INSTALLATION SCHEME/  
SCHEMA D'INSTALLATION/  
ESQUEMA DE INSTALAÇÃO



+

Producto/Product  
Produit/Produto

	2x9m
	20
	1800
	90
<b>W</b>	150W
	<b>NO Empalmable</b>

		
953191		
146241		



+ INFO PAG. 352 **Accesorios/Accessories/Accessoires/Acessórios**

977722

Cable alimentación Blanco

# SCREENLIGHT 300

## FLASHING

SMART  
LINK 



Escatrón -  
Zaragoza

 230V dc

 CII

 1 CANAL

 IP65

 -20°C~+60 °C

 NO INC.



146258



146456



2x1,5m



20

(2 tiras = 1 serie)



300



13+2  
flashing



30W



10sets

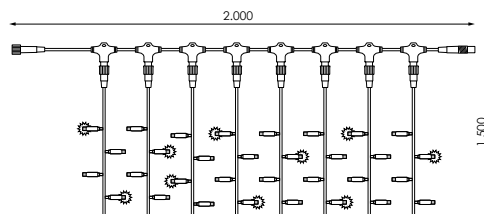

ESQUEMA INSTALACIÓN/  
INSTALLATION SCHEME/  
SCHÉMA D'INSTALLATION/  
ESQUEMA DE INSTALAÇÃO



+

Producto/Product  
Produit/Produto

Accesorios/Accessories/Accessoires/Acessórios + INFO PAG. 352









977722

Cable alimentación Blanco

# SCREENLIGHT 600

## FLASHING

SMART  
LINK 

	230V dc
	CII
	1 CANAL
	IP65
	-20°C~+60 °C
	NO INC.



Restaurante La Santina -  
Galapagar, (Madrid)

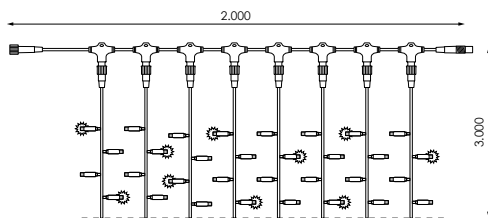













ESQUEMA INSTALACIÓN/  
INSTALLATION SCHEME/  
SCHEMA D'INSTALLATION/  
ESQUEMA DE INSTALAÇÃO



+

Producto/Product  
Produit/Produto

	2x3m
	20 (2 filas = 1 serie)
	600
	26+4 flashing
	35W
	7sets

		
163606		
146555		



+ INFO PAG. 352 **Accesorios/Accessories/Accessoires/Acessórios**

977722

Cable alimentación Blanco

# SCREENLIGHT 1200

## FLASHING

SMART LINK 



CC. Mendibil - Irún

 230V dc









 CII





 1 CANAL

 IP65

 -20°C~+60 °C

 NO INC.

		
163613	 	
146562	 	

	2x6m
	20
	1200
	54+6 flashing
<b>W</b>	73W
	3sets

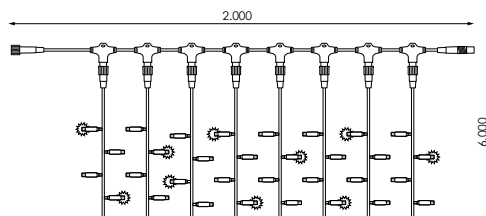

ESQUEMA INSTALACIÓN/  
INSTALLATION SCHEME/  
SCHEMA D'INSTALLATION/  
ESQUEMA DE INSTALAÇÃO



+

Producto/Product  
Produit/Produto

Accesorios/Accessories/Accessoires/Acessórios + INFO PAG. 352









977722

Cable alimentación Blanco

# SCREENLIGHT 1800

## FLASHING

	230V dc
	CII
	1 CANAL
	IP65
	-20°C~+60 °C
	NO INC.



SMART LINK 

CC. Luz del Tajo - Toledo

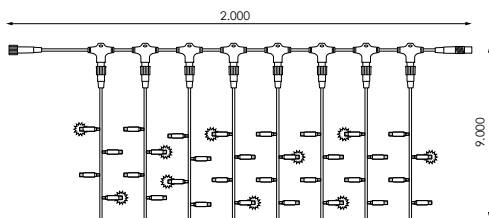















ESQUEMA INSTALACIÓN/  
INSTALLATION SCHEME/  
SCHEMA D'INSTALLATION/  
ESQUEMA DE INSTALAÇÃO



+

Producto/Product  
Produit/Produto

	2x9m
	20
	1800
	80+10 flashing
<b>W</b>	150W
	<b>NO Empalmable</b>

		
441698	 	
441704	 	



+ INFO PAG. 352

Accesorios/Accessories/Accessoires/Acessórios

977722

Cable alimentación Blanco

# SCREENLIGHT 300

## DUAL



 230V ac













 CII





 1 CANAL

 IP44

 -20°C~+60 °C

 NO INC.

		
192071	 	
192088	 	
192095	 	

	2x1,5m
	20
	300
	15
<b>W</b>	33W
	*Accesorios

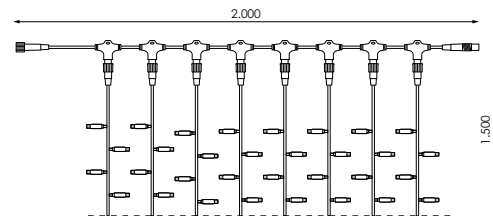

ESQUEMA INSTALACIÓN/  
INSTALLATION SCHEME/  
SCHEMA D'INSTALLATION/  
ESQUEMA DE INSTALAÇÃO



+

Producto/Product  
Produit/Produto

### Aviso/Warning/Avertissement/Aviso



**Ñ**/Los efectos de cambio de color solo funcionan con el controlador que es de **USO OBLIGATORIO**.

**E**/ The color change effects only work with the controller that is **OBLIGATORY**.

**F**/ Les effets de changement de couleur fonctionnent uniquement avec le contrôleur qui est **OBLIGATOIRE**.

**P**/ Os efeitos de mudança de cor funcionam apenas com o controlador que é **USO OBRIGATORIO**.

### Accesorios/Accessories/Accessoires/Acessórios + INFO PAG. 352



**Ñ**/La máxima longitud por alimentación, dependerá del controlador a utilizar. Controlador **NO INCLUIDO**.

**E**/ Maximum length for power, will depend on the driver to use. Controller **NOT INCLUDED**.

**F**/ Longueur maximale pour le pouvoir, dépendra le pilote à utiliser. Contrôleur **NON INCLUS**.

**P**/ Comprimento máximo para o poder, vai depender do driver para uso. Controlador **NÃO INCLUIDO**.

**971072**

Controlador 4 funciones 6A

**391559**

Controlador 8 funciones 2A blanco









**971072** max. 7 set/salida

**391559** 7 sets



# SCREENLIGHT 600

DUAL



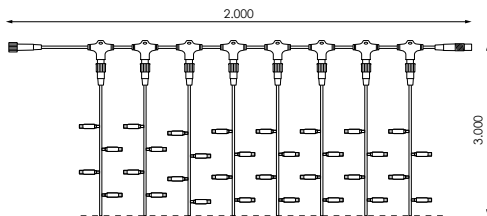

	230V ac
	CII
	1 CANAL
	IP44
	-20°C~+60 °C
	NO INC.









ESQUEMA INSTALACIÓN/  
INSTALLATION SCHEME/  
SCHEMA D'INSTALLATION/  
ESQUEMA DE INSTALAÇÃO



Producto/Product  
Produit/Produto

	2x3m
	20
	600
	30
<b>W</b>	35W
	*Accesorios

		
192101		
192125		



## Aviso/Warning/Avertissement/Aviso

**Ñ**/Los efectos de cambio de color solo funcionan con el controlador que es de **USO OBLIGATORIO**.

**E**/ The color change effects only work with the controller that is **OBLIGATORY**.

**F**/ Les effets de changement de couleur fonctionnent uniquement avec le contrôleur qui est **OBLIGATOIRE**.

**P**/ Os efeitos de mudança de cor funcionam apenas com o controlador que é **USO OBRIGATORIO**.



## + INFO PAG. 352 Accesorios/Accessories/Accessoires/Acessórios

**Ñ**/La máxima longitud por alimentación, dependerá del controlador a utilizar. Controlador **NO INCLUIDO**.

**E**/ Maximum length for power, will depend on the driver to use. Controller **NOT INCLUDED**.

**F**/ Longueur maximale pour le pouvoir, dépendra le pilote à utiliser. Contrôleur **NON INCLUS**.

**P**/ Comprimento máximo para o poder, vai depender do driver para uso. Controlador **NÃO INCLUIDO**.

**971072**

Controlador 4 funciones 6A

**391559**

Controlador 8 funciones 2A blanco



**971072**

max. 7 set/salida

**391559**

7 sets

# SCREENLIGHT 250

FALL LITE

SMART LINK 



 230V dc









 CII





 1 CANAL

 IP65

 -20°C~+60 °C

 NO INC.

		
388238	 	
388245	 	

	2x1m
	5
	250
	50
<b>W</b>	11W
	15sets

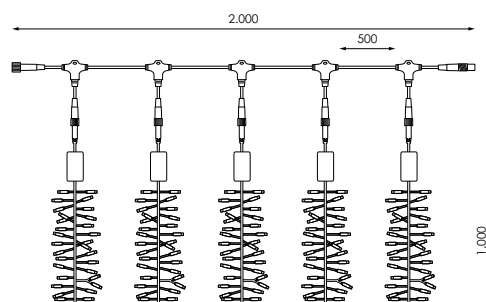

ESQUEMA INSTALACIÓN/  
INSTALLATION SCHEME/  
SCHÉMA D'INSTALLATION/  
ESQUEMA DE INSTALAÇÃO



+

Producto/Product  
Produit/Produto

Accesorios/Accessories/Accessoires/Acessórios + INFO PAG. 352



193078

Cable alimentación Blanco

# SCREEN Rain

## 2x2m

⚡ 24V

⚡ CIII

👁️ 4 CANALES

🌧️ IP44

📺 INC.

Ñ/ Controlador efecto lluvia ajustable en velocidad **INCLUIDO**.  
 E/ Controller adjustable rain's effect in speed **INCLUDED**.  
 F/ Contrôleur effet vitesse réglable de pluie **INCLUS**.  
 P/ Controlador ajustável chuva na velocidade **INCLUIDO**.



Fuensalida - Toledo

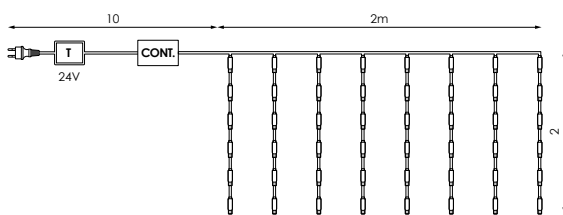

















↕	2x2m
👁️	16
💡	512
📏	32
W	17W
🚫	NO Empalmable

📊	💡	🔗
441711	LED	👁️

# ICICLE<sup>®</sup> 114

SMART  
LINK 

				<b>3x0,5m</b> (1,5m x 2seg)
977692				2
146364				114
163620				57
163637				8W
				20sets

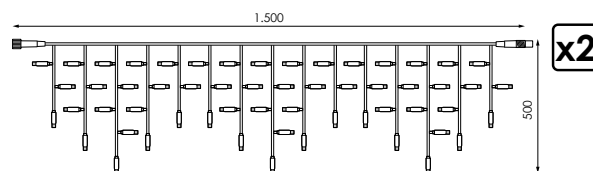

ESQUEMA INSTALACIÓN/  
INSTALLATION SCHEME/  
SCHEMA D'INSTALLATION/  
ESQUEMA DE INSTALAÇÃO



+

Producto/Product  
Produit/Produto

Accesorios/Accessories/Accessoires/Acessórios + INFO PAG. 352



995092

















Cable alimentación Negro

977722

Cable alimentación Blanco

# ICICLE<sup>®</sup> 174

SMART  
LINK 

				<b>3x0,9m</b> (1m x 3seg)
163644				3
163552				174
161305				58
543026				10,5W
				15sets

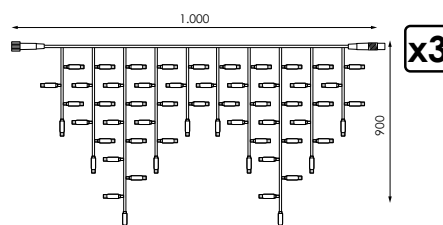

ESQUEMA INSTALACIÓN/  
INSTALLATION SCHEME/  
SCHEMA D'INSTALLATION/  
ESQUEMA DE INSTALAÇÃO



+

Producto/Product  
Produit/Produto

Accesorios/Accessories/Accessoires/Acessórios + INFO PAG. 352



995092







Cable alimentación Negro

977722

Cable alimentación Blanco

# ICICLE<sup>®</sup> 304

SMART  
LINK 

	230V dc
	CII
	1 CANAL
	IP65
	-20°C~+60 °C
	NO INC.



CC. Lagoh -  
Sevilla

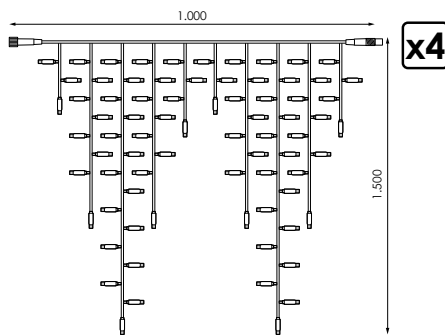





















ESQUEMA INSTALACIÓN/  
INSTALLATION SCHEME/  
SCHEMA D'INSTALLATION/  
ESQUEMA DE INSTALAÇÃO



+

Producto/Product  
Produit/Produto

	<b>4x1,5m</b> (1m x 4seg)
	<b>4</b>
	<b>304</b>
	<b>76</b>
	<b>25W</b>
	<b>10sets</b>

		
163675	 	
163682	 	
163699	 	
163705	 	



+ INFO PAG. 352 **Accesorios/Accessories/Accessoires/Acessórios**

**995092**

Cable alimentación Negro















**977722**

Cable alimentación Blanco

# ICICLE<sup>®</sup> 114

## FLASHING

SMART  
LINK 

				<b>3x0,5m</b> (1,5m x 2seg)
<b>146388</b>				<b>2</b>
<b>146371</b>				<b>114</b>
<b>543019</b>				<b>49+8</b> <b>flashing</b>
				<b>8,2W</b>
				<b>20sets</b>

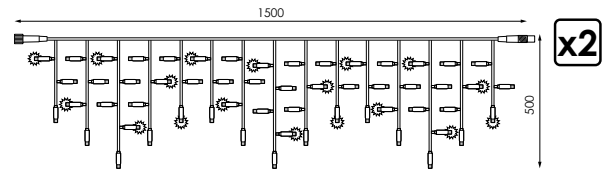

ESQUEMA INSTALACIÓN/  
INSTALLATION SCHEME/  
SCHEMA D'INSTALLATION/  
ESQUEMA DE INSTALAÇÃO



+

Producto/Product  
Produit/Produto

Accesorios/Accessories/Accessoires/Acessórios + INFO PAG. 352

















977722

Cable alimentación Blanco

# ICICLE<sup>®</sup> 174

## FLASHING

SMART  
LINK 

				<b>3x0,9m</b> (1m x 3seg)
<b>146395</b>				<b>3</b>
<b>146401</b>				<b>174</b>
<b>543033</b>				<b>50+8</b> <b>flashing</b>
				<b>11W</b>
				<b>15sets</b>

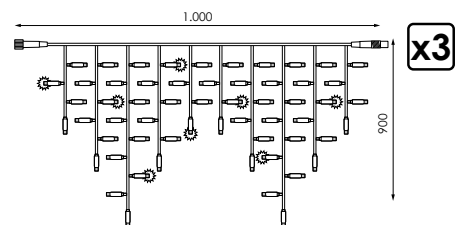

ESQUEMA INSTALACIÓN/  
INSTALLATION SCHEME/  
SCHEMA D'INSTALLATION/  
ESQUEMA DE INSTALAÇÃO



+

Producto/Product  
Produit/Produto

Accesorios/Accessories/Accessoires/Acessórios + INFO PAG. 352









977722

Cable alimentación Blanco

# ICICLE 304

## FLASHING

SMART  
LINK

	230V dc
	CII
	1 CANAL
	IP65
	-20°C~+60 °C
	NO INC.





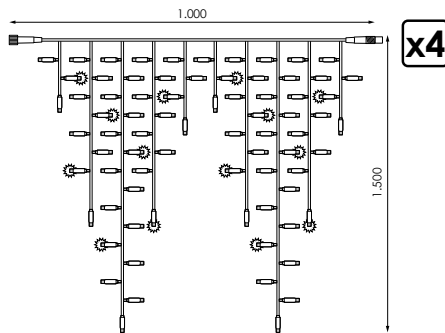



La Palma del Condado - Huelva









ESQUEMA INSTALACIÓN/  
INSTALLATION SCHEME/  
SCHEMA D'INSTALLATION/  
ESQUEMA DE INSTALAÇÃO



+ Producto/Product  
Produit/Produto

	4x1,5m (1m x 4seg)
	4
	304
	66+10 flashing
	25W
	10sets

		
546591		
546607		



+ INFO PAG. 352 **Accesorios/Accessories/Accessoires/Acessórios**

977722

Cable alimentación Blanco

# Cascada

4m

				4m
075824				5
192187				480
075817				96
			<b>W</b>	26,9W
				NO Empalmable

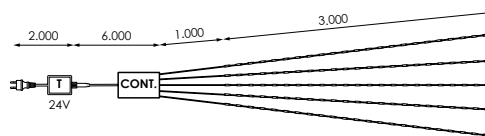

## Información/Information/Information/Informações



Ñ/ Controlador 8 funciones **INCLUIDO**.

E/ Controller 8 functions **INCLUDED**.

F/ Contrôleur 8 fonctions **INCLUS**.

P/ Controlador 8 funções **INCLUÍDO**.

# Cascada

7m

				7m
075848				5
192194				960
075831				192
			<b>W</b>	43W
				NO Empalmable

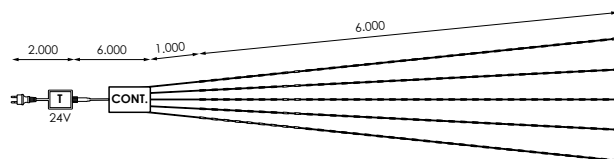

## Información/Information/Information/Informações



Ñ/ Controlador 8 funciones **INCLUIDO**.

E/ Controller 8 functions **INCLUDED**.

F/ Contrôleur 8 fonctions **INCLUS**.

P/ Controlador 8 funções **INCLUÍDO**.



⚡ 24V

⬡ CIII

👁 4 CANALES

☂ IP44

ⓐ INC.





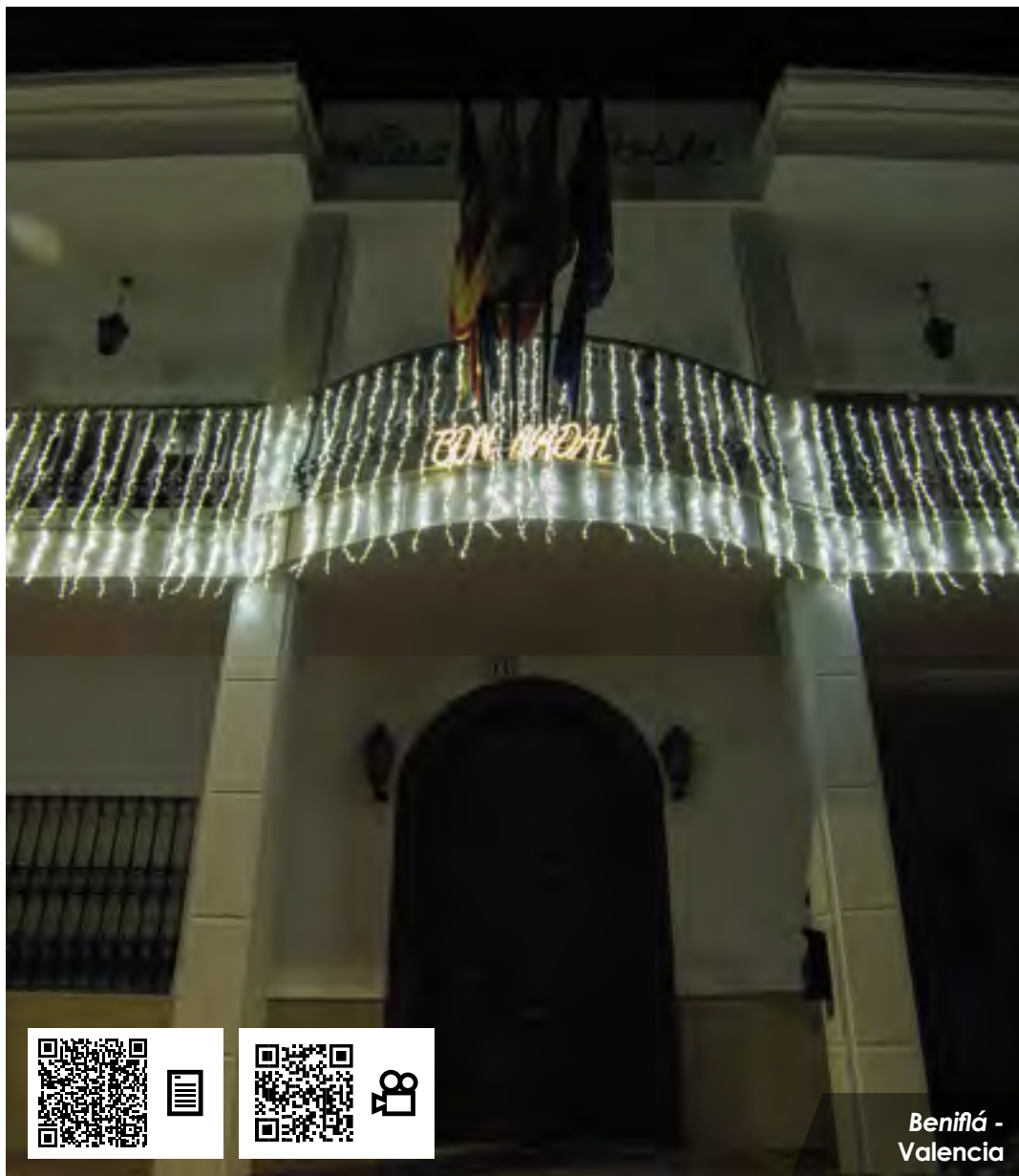

[GRÁFICOS: Unidades en mm/ GRAPHICS: Units in mm/ GRAPHIQUES: Unités en mm/ GRÁFICOS: Unidades em mm]

# SCREENLIGHT Cascada













2x1,5m



	24V
	CIII
	4 CANALES
	IP44
	INC.



Beniflá -  
Valencia

				2x1,5m
087094				16
087100				768
				48
			<b>W</b>	35W
				NO Empalmable

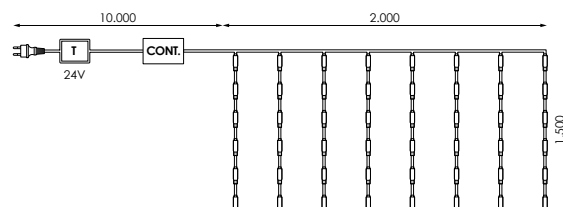

## Información/Information/Information/Informações







Ñ/ Controlador 8 funciones **INCLUI-**  
**DO.**

E/ Controller 8 functions **INCLUDED.**

F/ Contrôleur 8 fonctions **INCLUS.**

P/ Controlador 8 funções **INCLUÍDO.**





# ICICLE® Cascada



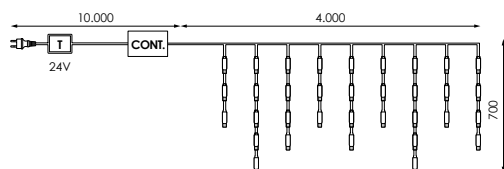





	24V
	CIII
	4 CANALES
	IP44
	INC.









Hotel Spa Relais & Chateaux a Quinta Da Agua - Santiago de Compostela

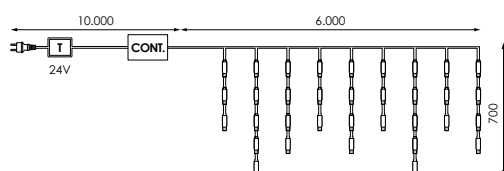









	4x0,7m
	32
	576
	12/24/16/20
<b>W</b>	34,5W
	NO Empalmable

		
087155		
192217		
087162		



	6x0,7m
	48
	864
	12/24/16/20
<b>W</b>	39W
	NO Empalmable

		
087179		
192224		
087186		



## Información/Information/Information/Informações

Ñ/ Controlador 8 funciones **INCLUIDO**.

E/ Controller 8 functions **INCLUDED**.

F/ Contrôleur 8 fonctions **INCLUS**.

P/ Controlador 8 funções **INCLUIDO**.

# Red 24V

## 2x1m TRANSFORMADOR



Cuidad Real

24V dc

CIII

1 CANAL

IP44

-20°C~+60°C

NO INC.

NO INC.

953627

2x1m

100

**W** 6,5W

Máx. 10 sets en serie

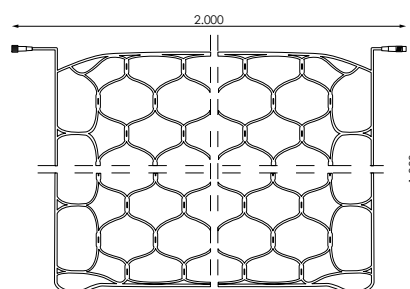

ESQUEMA INSTALACIÓN/  
INSTALLATION SCHEME/  
SCHEMA D'INSTALLATION/  
ESQUEMA DE INSTALAÇÃO



### Aviso/Warning/Avertissement/Aviso



Ñ/ Uso **OBLIGATORIO** de transformador y rectificador.

E/ You **MUST USE** the transformer and rectifier.

F/ L'utilisation **OBLIGATOIRE** du transformateur et redresseur.

P/ Uso **OBRIGATÓRIO** de transformador e retificador.

### Accesorios/Accessories/Accessoires/Acessórios + INFO PAG. 352



Ñ/ Transformador y rectificador **NO INCLUIDO**

E/ Transformer and rectifier **NOT INCLUDED**

F/ Transformateur et redresseur **NON INCLUS**

P/ Transformador e retificador **NÃO INCLUIDO**







<b>149181</b>	Transformador 10,8W
<b>149204</b>	Transformador 60W
<b>150323</b>	Rectificador máx. 60W

<b>149198</b>	Transformador 28,8W
<b>149211</b>	Transformador 120W
<b>364478</b>	Rectificador máx. 96W

<b>149181</b>	1 set
<b>149198</b>	4 sets
<b>149204</b>	9 sets
<b>149211</b>	18 sets

# Red 24V

## 2x1m FUENTE ALIMENTACIÓN

	24V dc
	CIII
	1 CANAL
	IP65
	-20°C~+60 °C
	NO INC.

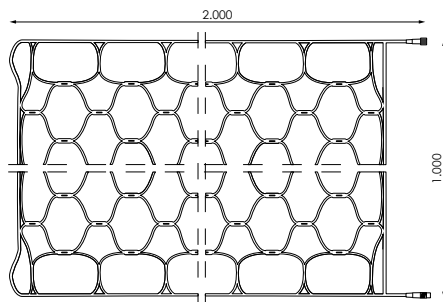









ESQUEMA INSTALACIÓN/  
INSTALLATION SCHEME/  
SCHEMA D'INSTALLATION/  
ESQUEMA DE INSTALAÇÃO



+

Producto/Product  
Produit/Produto

	2x1m
	98
<b>W</b>	6,5W
	Máx. 10 sets en serie

		
163194		



### Aviso/Warning/Avertissement/Aviso

**Ñ/** Uso **OBLIGATORIO** de fuente de alimentación.

**E/** You **MUST USE** the power supply.

**F/** L'utilisation **OBLIGATOIRE** de l'alimentation

**P/** Uso **OBRIGATÓRIO** fonte de alimentação.



+ INFO PAG. 352 **Accesorios/Accessories/Accessoires/Acessórios**

**Ñ/** Fuente de alimentación **NO INCLUIDA**

**E/** Power supply **NOT INCLUDED**

**F/** Alimentation **NON INCLUSE**

**P/** Fonte de alimentação **NÃO INCLUIDO**

**488440**

Fuente alimentación 30W 24V

**481687**

Fuente alimentación 150W 24V

**488457**

Fuente alimentación 60W 24V

**481694**

Fuente alimentación 200W 24V











**488464**



Fuente alimentación 100W 24V

# Red

## 2x1m

SMART  
LINK 

		
192231		
192248		
192255		
192262		

	2x1m
	200
<b>W</b>	18W
	15sets

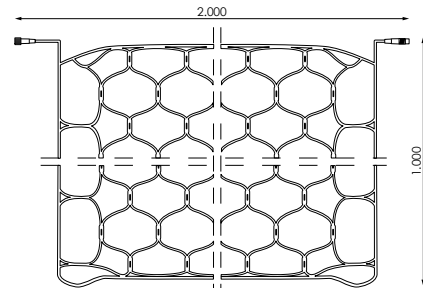

ESQUEMA INSTALACIÓN/  
INSTALLATION SCHEME/  
SCHÉMA D'INSTALLATION/  
ESQUEMA DE INSTALAÇÃO



+

Producto/Product  
Produit/Produto

### Accesorios/Accessories/Accessoires/Acessórios + INFO PAG. 352













<b>995092</b>
Cable alimentación Negro



<b>977722</b>
Cable alimentación Blanco

# Red

## 4x2m

SMART  
LINK 

		
192279		
192286		
192293		
192309		

	4x2m
	400
<b>W</b>	27W
	7sets

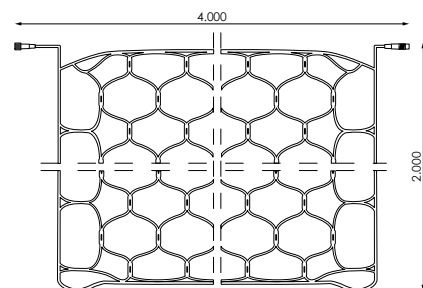

ESQUEMA INSTALACIÓN/  
INSTALLATION SCHEME/  
SCHÉMA D'INSTALLATION/  
ESQUEMA DE INSTALAÇÃO



+

Producto/Product  
Produit/Produto

### Accesorios/Accessories/Accessoires/Acessórios + INFO PAG. 352



<b>995092</b>
Cable alimentación Negro

<b>977722</b>
Cable alimentación Blanco

⚡ 230V dc

□ CII

👁️ 1 CANAL

🌫️ IP65

🌡️ -20°C~+60 °C

⚡ NO INC.



Viveiro -  
Lugo



# Red Flashing

SMART  
LINK 



Cortijo MBI -  
Sevilla

 230V dc

 CII

 1 CANAL

 IP65

 -20°C~+60 °C

 NO INC.









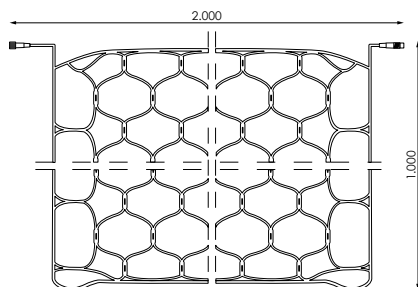



# Red Flashing

## 2x1m

SMART  
LINK 



	2x1m
	170+30 flashing
<b>W</b>	18W
	15sets

		
386081		
386098		

ESQUEMA INSTALACIÓN/  
INSTALLATION SCHEME/  
SCHEMA D'INSTALLATION/  
ESQUEMA DE INSTALAÇÃO



+

Producto/Product  
Produit/Produto



+ INFO PAG. 352 **Accesorios/Accessories/Accessoires/Acessórios**

995092



Cable alimentación Negro





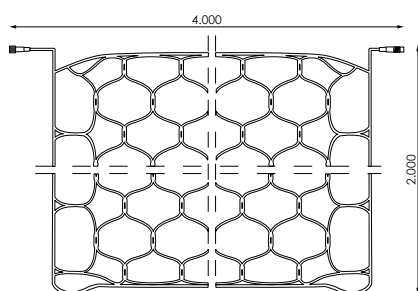

# Red Flashing

## 4x2m

SMART  
LINK 



	4x2m
	340+60 flashing
<b>W</b>	27W
	7sets

		
386104		
386111		

ESQUEMA INSTALACIÓN/  
INSTALLATION SCHEME/  
SCHEMA D'INSTALLATION/  
ESQUEMA DE INSTALAÇÃO



+

Producto/Product  
Produit/Produto



+ INFO PAG. 352 **Accesorios/Accessories/Accessoires/Acessórios**



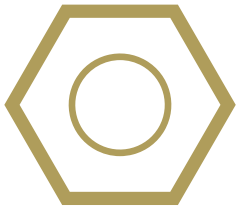

995092



Cable alimentación Negro



# Accesorios

Accessories  
Accessoires  
Acessórios

		String AVANT 180 IP67 / String AVANT 180 IP67 FLASHING	STRING PLUS 180 24V / STRING PLUS 180 24V FLASHING	STRING PLUS 180 / STRING PLUS 180 FLASHING	STRING PLUS 120 ALL FLASHING	STRING PLUS 180 SPARKLES	STRING PLUS 180 DUAL	SCREENLIGHT 300 24V	SCREENLIGHT 600 24V	SCREENLIGHT / SCREENLIGHT FLASHING	SCREENLIGHT ALL FLASHING	SCREENLIGHT DUAL	SCREENLIGHT 250 FALL LITE	Cluster Light FALL LITE	Cluster Light FLASHING	Techo luz SCREENLIGHT FLASHING	ICICLE / ICICLE FLASHING	Red 24V	Red / Red FLASHING	
	149181		•															•		
	149198		•															•		
	149204		•						•									•		
	149211		•						•									•		
	150323		•						•									•		
	192507									•	•				•	•	•		•	
	192514									•	•				•	•	•		•	
	193061												•	•						
	193078												•	•						
	364478		•						•									•		
	481687		•					•										•		
	481694		•					•										•		
	487207	•																		
	487214	•																		
	487474	•																		
	487581	•																		
	488440		•						•										•	
	488457		•						•										•	
	488464		•						•										•	
	977722				•	•	•				•	•				•	•	•		•
	995092				•	•	•				•	•				•	•	•		•
		391559						•					•							
		971072						•					•							
		192323			•	•	•				•	•		•	•	•	•	•		•
192347				•	•	•				•	•		•	•	•	•	•		•	
192354				•	•	•				•	•		•	•	•	•	•		•	
192361				•	•	•				•	•		•	•	•	•	•		•	
192378				•	•	•				•	•		•	•	•	•	•		•	
192385				•	•	•				•	•		•	•	•	•	•		•	
192392				•	•	•				•	•		•	•	•	•	•		•	
192408				•	•	•				•	•		•	•	•	•	•		•	
192415				•	•	•				•	•		•	•	•	•	•		•	
192422				•	•	•				•	•		•	•	•	•	•		•	
192439				•	•	•				•	•		•	•	•	•	•		•	
192446				•	•	•				•	•		•	•	•	•	•		•	
192453				•	•	•				•	•		•	•	•	•	•		•	
192477				•	•	•				•	•		•	•	•	•	•		•	
192484				•	•	•				•	•		•	•	•	•	•		•	
192491				•	•	•				•	•		•	•	•	•	•		•	
388368				•	•	•				•	•		•	•	•	•	•		•	

		String AVANT 180 IP67 / String AVANT 180 IP67 FLASHING	STRING PLUS 180 24V / STRING PLUS 180 24V FLASHING	STRING PLUS 180 / STRING PLUS 180 FLASHING	STRING PLUS 120 ALL FLASHING	STRING PLUS 180 SPARKLES	STRING PLUS 180 DUAL	SCREENLIGHT 300 24V	SCREENLIGHT 600 24V	SCREENLIGHT / SCREENLIGHT FLASHING	SCREENLIGHT ALL FLASHING	SCREENLIGHT DUAL	SCREENLIGHT 250 FALL LITE	Cluster Light FALL LITE	Cluster Light FLASHING	Techo luz SCREENLIGHT FLASHING	ICICLE# / ICICLE# FLASHING	Red 24V	Red / Red FLASHING
388375				•	•	•				•	•		•	•	•	•	•		•
388382				•	•	•				•	•		•	•	•	•	•		•
388399				•	•	•				•	•		•	•	•	•	•		•
388498				•	•	•				•	•		•	•	•	•	•		•
388504				•	•	•				•	•		•	•	•	•	•		•
391498				•	•	•				•	•		•	•	•	•	•		•
391504				•	•	•				•	•		•	•	•	•	•		•
391535		•					•	•	•			•						•	
481700		•					•	•	•			•						•	
481717		•					•	•	•			•						•	
481724		•					•	•	•			•						•	
487221	•											•							
487238	•																		
487245	•																		
487252	•																		
487269	•																		
487276	•																		
487283	•																		
487344	•																		
487375	•																		
487382	•																		
487399	•																		
487405	•																		
487412	•																		
487429	•																		
487436	•																		
487443	•																		
487450	•																		
487467	•																		
553698	•	•	•	•	•	•	•	•	•	•	•	•	•	•	•	•	•	•	•
971140		•					•	•	•			•						•	•
971188		•					•	•	•			•						•	•
971195		•					•	•	•			•						•	•
971201		•					•	•	•			•						•	•
971218		•					•	•	•			•						•	•
400794				•	•	•				•	•		•	•	•	•	•	•	•

### CABLE ALIMENTACIÓN AVANT

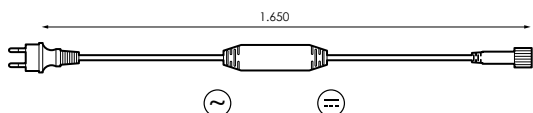

<b>R</b>				<b>W</b>		
	<b>487207</b>		230Vac	Max. 480W	CII	IP44 Plug IP67 Conector
	<b>487214</b>		230Vac	Max. 480W	CII	IP44 Plug IP67 Conector

### RECTIFICADOR AVANT

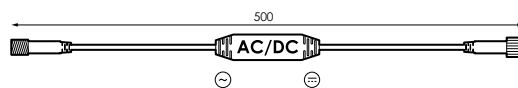

<b>R</b>			<b>W</b>		
	<b>487481</b>		Max. 460W	CII	IP67
	<b>487474</b>		Max. 460W	CII	IP67

### ADAPTADOR AVANT

SMART-FLEXILIGHT

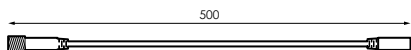

<b>A</b>			
	<b>487443</b>		IP67
	<b>487436</b>		IP67

Termoretractil y conector macho **NO INCLUIDOS**  
Heat-shrinkable and male connector **NOT INCLUDED**  
Thermorétractable et connecteur mâle **NON INCLUS**  
Tubo de contração térmica e conector macho **NÃO INCLUIDO**

### ADAPTADOR AVANT

FLEXILIGHT-SMART

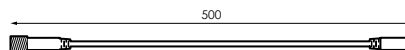

<b>A</b>			
	<b>487467</b>		IP67
	<b>487450</b>		IP67

Termoretractil y conector macho **NO INCLUIDOS**  
Heat-shrinkable and male connector **NOT INCLUDED**  
Thermorétractable et connecteur mâle **NON INCLUS**  
Tubo de contração térmica e conector macho **NÃO INCLUIDO**

### EXTENSIÓN AVANT

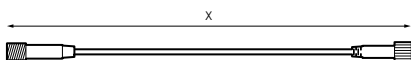

<b>487238</b>	1m		IP67
<b>487221</b>	1m		IP67
<b>487252</b>	3m		IP67
<b>487245</b>	3m		IP67
<b>487276</b>	5m		IP67
<b>487269</b>	5m		IP67

### CONECTOR 5 AVANT

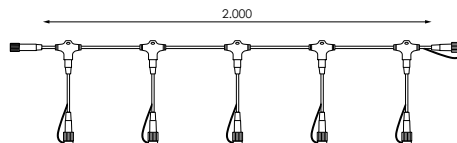

<b>487382</b>	2m	5		IP67
<b>487375</b>	2m	5		IP67

### CONECTOR 10 AVANT

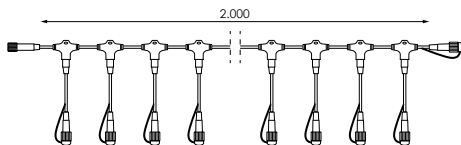

<b>487405</b>	2m	10		IP67
<b>487399</b>	2m	10		IP67

### CONECTOR 10 AVANT

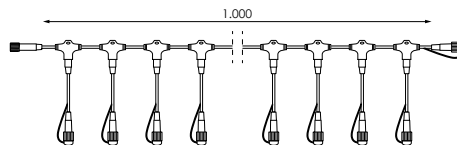

<b>487344</b>	1m	10		IP67
<b>487283</b>	1m	10		IP67

**CONECTOR T AVANT**

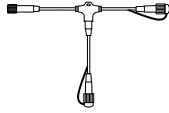

487429



IP67

487412



IP67

**TRANSFORMADOR 24V**

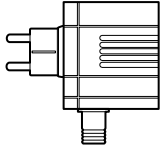

**W**

149181

Máx. 10,8W

Sin rectificador  
Without rectifier  
Sans redresseur  
Sem retificador

**TRANSFORMADOR 24V**

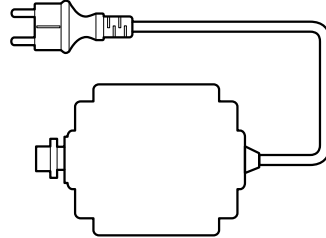

**W**

149198

Máx. 28,8W

Sin rectificador  
Without rectifier  
Sans redresseur  
Sem retificador

**TRANSFORMADOR 24V**

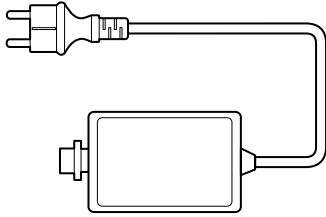

**W**

149204

Max. 60W

Sin rectificador  
Without rectifier  
Sans redresseur  
Sem retificador

**TRANSFORMADOR 24V**

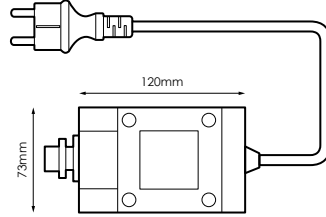

**W**

149211

Max. 120W

Sin rectificador  
Without rectifier  
Sans redresseur  
Sem retificador

**RECTIFICADOR 24V**

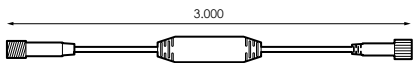

**W**

150323

3m

Max. 60W

364478

3m

Max. 90W

**FUENTE ALIMENTACIÓN 24V**

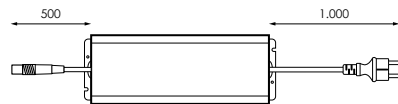

**W**



488440

24V

30W

IP66/ IP44 Plug

488457

24V

60W

IP66/ IP44 Plug

488464

24V

100W

IP66/ IP44 Plug

481687

24V

150W

IP66/ IP44 Plug

481694

24V

200W

IP66/ IP44 Plug

### CABLE ALIMENTACIÓN SMART LINK

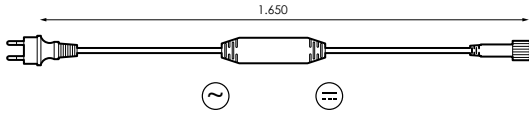

<b>R</b>				<b>W</b>		
	<b>995092</b>		230Vac	Max. 480W	CII	IP44 Plug IP65 Conector
	<b>977722</b>		230Vac	Max. 480W	CII	IP44 Plug IP65 Conector

### CABLE ALIMENTACIÓN SMART LINK

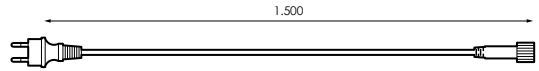

<b>R</b>				<b>W</b>		
	<b>193061</b>		230Vac	Max. 480W	CII	IP44 Plug IP65 Conector
	<b>193078</b>		230Vac	Max. 480W	CII	IP44 Plug IP65 Conector

### RECTIFICADOR SMART LINK

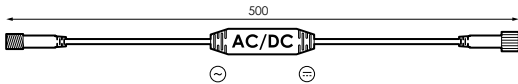

<b>R</b>			<b>W</b>		
	<b>192514</b>		Max. 460W	CII	IP65
	<b>192507</b>		Max. 460W	CII	IP65

### TAPA FINAL SMART LINK



<b>400794</b>	<b>Bl</b> Blanco

### EXTENSIÓN SMART LINK

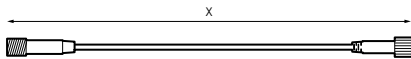

	<b>L</b>		
<b>388498</b>	0,5m		IP65
<b>388504</b>	0,5m		IP65
<b>192347</b>	1m		IP65
<b>192323</b>	1m		IP65
<b>192361</b>	3m		IP65
<b>192354</b>	3m		IP65
<b>192385</b>	5m		IP65
<b>192378</b>	5m		IP65

### TERMORRETRACTIL

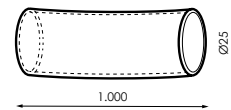

	Termoretractil Ø25mm, corte 1m. Heat-shrinkable Ø25mm, cut 1m. Ø25mm thermorétractable, couper 1m. Tubo contração térmica Ø25mm, corte 1m.
<b>553698</b>	
<b>972451</b>	Pistola aire caliente profesional 2000W Hot air gun professional 2000W Pistolet à air chaud 2000W professionnel Soprador de ar quente 2000W profissional

### ADAPTADOR SMART LINK

#### SMART-FLEXILIGHT

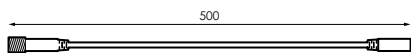

<b>A</b>			
	<b>192477</b>		IP65
	<b>192453</b>		IP65

Termoretractil y conector macho **NO INCLUIDOS**  
Heat-shrinkable and male connector **NOT INCLUDED**  
Thermorétractable et connecteur mâle **NON INCLUS**  
Tubo de contração térmica e conector macho **NÃO INCLUIDO**

### ADAPTADOR SMART LINK

#### FLEXILIGHT-SMART

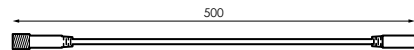

<b>A</b>			
	<b>192491</b>		IP65
	<b>192484</b>		IP65

Termoretractil y conector macho **NO INCLUIDOS**  
Heat-shrinkable and male connector **NOT INCLUDED**  
Thermorétractable et connecteur mâle **NON INCLUS**  
Tubo de contração térmica e conector macho **NÃO INCLUIDO**

### CONECTOR T SMART LINK

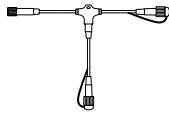

192446



IP65

192439



IP65

### CONECTOR X SMART LINK

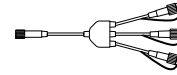

391504



IP65

391498



IP65

### CONECTOR 5 SMART LINK

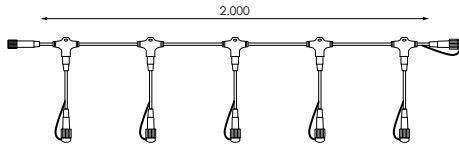

388375

2m

5



IP65

388368

2m

5



IP65

### CONECTOR 10 SMART LINK

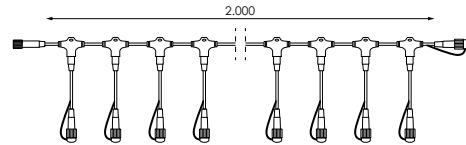

388399

2m

10



IP65

388382

2m

10



IP65

### CONECTOR 10 SMART LINK

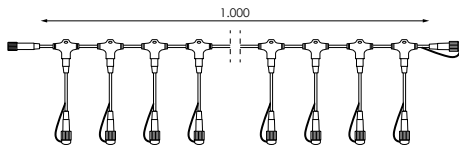

192408

1m

10



IP65

192392

1m

10



IP65

### CONECTOR 20 SMART LINK

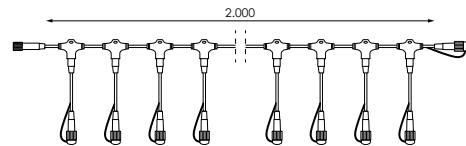

192422

2m

20



IP65

192415

2m

20



IP65

**CONTROLADOR DUAL**

2A

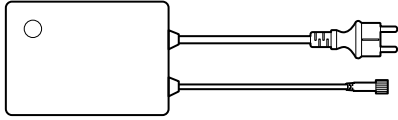

**CONTROLADOR DUAL**

6A

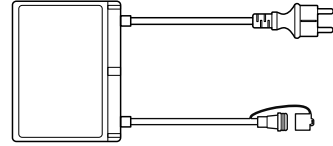

**391559**



230V

**W**

Max. 240W

8 funciones efecto memoria  
8 functions memory effect  
8 fonctions effet mémoire  
8 funções efeito de memória



**971072**



230V

**W**

Max. 1.200W



\*Max. 240m

\*Máx. 240m (máx. 90m por salida) / 4 funciones  
\*Max. 240m (max. 90m per output) / 4 functions  
\*Max. 240m (max. 90m par sortie) / 4 fonctions  
\*Max. 240m (max. 90m por saída) / 4 funções

**EXTENSIÓN DUAL/24V**

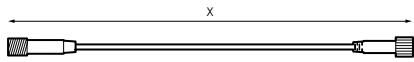

**391535**



0,5m

**481724**

1m

**971188**

3m

**971140**

5m

**CONECTOR DUAL/24V**

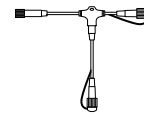

**971218**

Conector T  
Connector T  
Connecteur en T  
Conector em T

**CONECTOR 10 DUAL/24V**

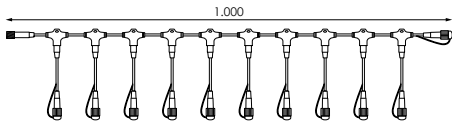

**971195**



1m



10

**CONECTOR 5 DUAL/24V**

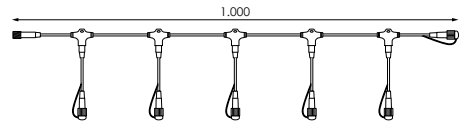

**971201**



1m



5

**CONECTOR 10 DUAL/24V**

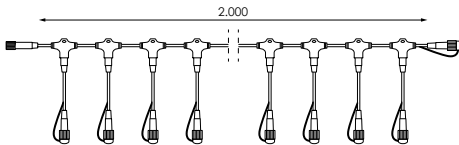

**481700**



2m



10



IP44

**CONECTOR 20 DUAL/24V**

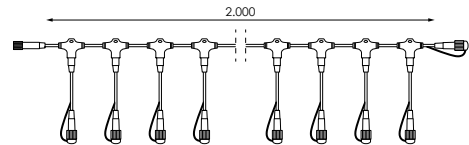

**481717**



2m



20



IP44





# *Led Interior*

---

*Indoors Led*

*Led à l'intérieur*



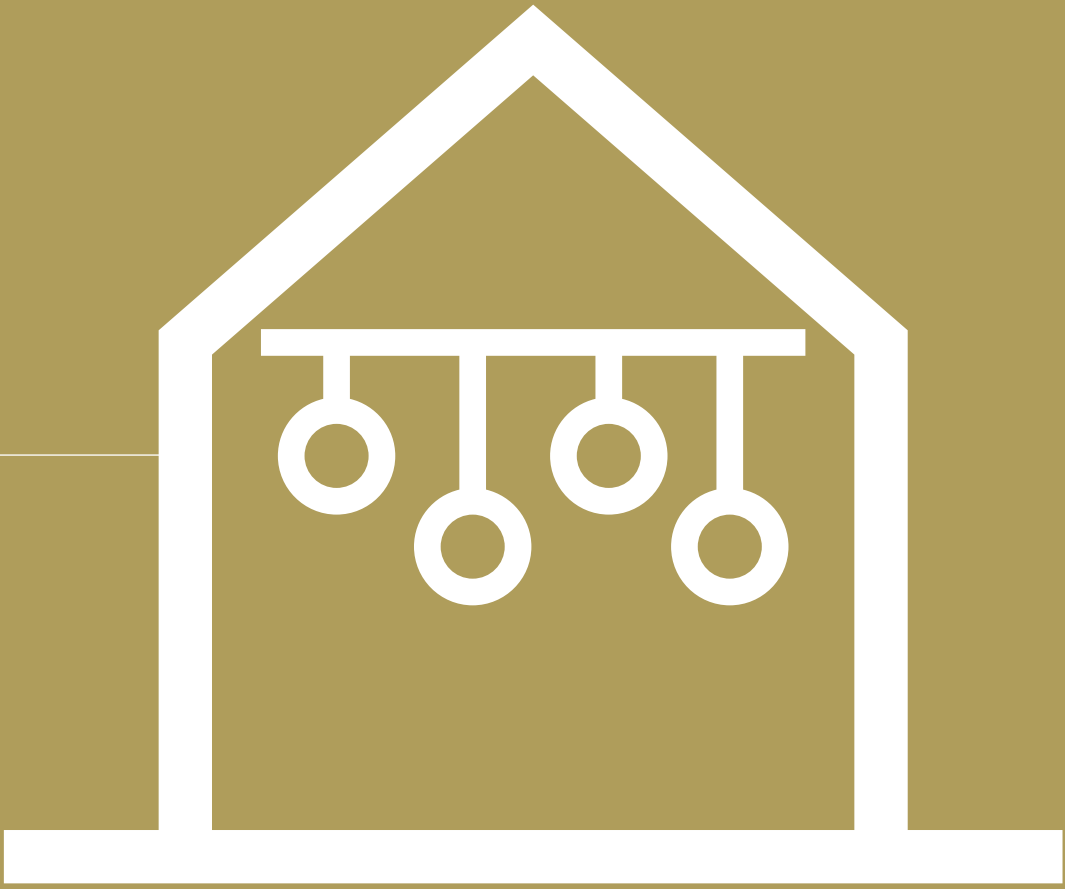



*Led Interior*













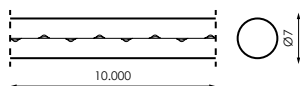









# flexiLIGHT LED

Ø7mm

	6V
	CIII
	1 CANAL/ 2 VÍAS
	IP44
	360°
	-20°C~+60 °C
	INC.

Ñ/ \*Con movimiento. E/ \*With movement. F/ \*Avec mouvement. P/ \*Com movimento.



	7mm			
	20	192521		
<b>W</b>	6W	192538		
	<b>NO Empalmable</b>	192545		
	Rollo 10m	192552		
		192569*		



Aviso/Warning/Avertissement/Aviso

Ñ/ Transformador **INCLUIDO**.

E/ Transformer **INCLUDED**.







F/ Transformateur **INCLUS**.













P/ Transformador **INCLUIDO**.







# STRING **PLUS** 180

SMART LINK 



	230V dc
	CII
	1 CANAL
	IP20
	-20°C~+60 °C
	NO INC.

		
192576		
192583		
405874		
405850		
405867		

	12m (4m x 3seg)
	4m
	180
	60
<b>W</b>	10W
	3,5W
	100m

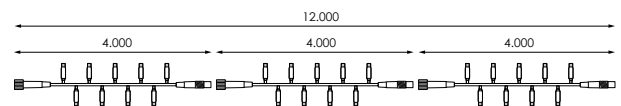

ESQUEMA INSTALACIÓN/  
INSTALLATION SCHEME/  
SCHEMA D'INSTALLATION/  
ESQUEMA DE INSTALAÇÃO



+

Producto/Product  
Produit/Produto

Accesorios/Accessories/Accessoires/Acessórios + INFO PAG. 372



192606  
Cable alimentación Transparente

# STRING **PLUS** 180

## FLASHING

SMART  
LINK 

 230V dc

 CII

 1 CANAL

 IP20

 -20°C~+60 °C

 NO INC.

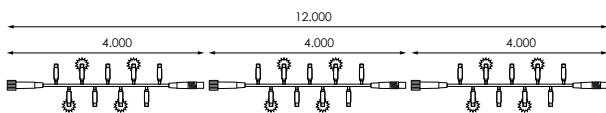

ESQUEMA INSTALACIÓN/  
INSTALLATION SCHEME/  
SCHEMA D'INSTALLATION/  
ESQUEMA DE INSTALAÇÃO



+

Producto/Product  
Produit/Produto



**12m**  
(4m x 3seg)



**4m**



**180**



**50+10**  
flashing



**10W**



**3,5W**



**100m**



**413756**



**413763**



+ INFO PAG. 372

**Accesorios/Accessories/Accessoires/Acessórios**

**192606**

Cable alimentación Transparente

# Cluster Light

FALL LITE 3m

SMART LINK 



 230V

 CII

 IP20

 -20°C~+60 °C

 NO INC.

 INC.



388269



LED



388276

LED



3m



6cm



150

W

3,5W



NO  
Empalmable

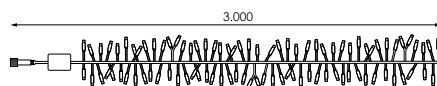

ESQUEMA INSTALACIÓN/  
INSTALLATION SCHEME/  
SCHÉMA D'INSTALLATION/  
ESQUEMA DE INSTALAÇÃO



+

Producto/Product  
Produit/Produto

Accesorios/Accessories/Accessoires/Acessórios + INFO PAG. 372



193061

Cable alimentación Negro

193078

Cable alimentación Blanco



# Cluster Light

## FALL LITE 5m

SMART  
LINK 



ESQUEMA INSTALACIÓN/  
INSTALLATION SCHEME/  
SCHEMA D'INSTALLATION/  
ESQUEMA DE INSTALAÇÃO



+

Producto/Product  
Produit/Produto



5m



6cm



250



6W



NO  
Empalmable



388283



388290



+ INFO PAG. 372 **Accesorios/Accessories/Accessoires/Acessórios**

193061

Cable alimentación Negro

193078

Cable alimentación Blanco

# Cluster Light

## FALL LITE 10m

SMART  
LINK 

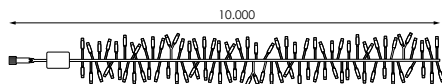

ESQUEMA INSTALACIÓN/  
INSTALLATION SCHEME/  
SCHEMA D'INSTALLATION/  
ESQUEMA DE INSTALAÇÃO



+

Producto/Product  
Produit/Produto



10m



6cm



500



12W



NO  
Empalmable



388306



388313



+ INFO PAG. 372 **Accesorios/Accessories/Accessoires/Acessórios**

193061

Cable alimentación Negro

193078

Cable alimentación Blanco

# SCREENLIGHT 300

## FLASHING

SMART LINK 



Perequera - Alicante



 230V dc

 CII

 1 CANAL

 IP20

 -20°C~+60 °C

 NO INC.



388320



388337



2x1,5m



20  
(2 tiras = 1 serie)



300



13+2  
flashing



29W



10sets

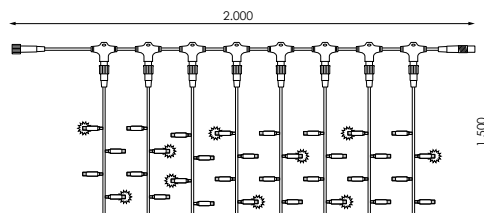

ESQUEMA INSTALACIÓN/  
INSTALLATION SCHEME/  
SCHÉMA D'INSTALLATION/  
ESQUEMA DE INSTALAÇÃO



+

Producto/Product  
Produit/Produto

Accesorios/Accessories/Accessoires/Acessórios + INFO PAG. 372









192606

Cable alimentación Transparente

# SCREENLIGHT 600

## FLASHING

	230V dc
	CII
	1 CANAL
	IP20
	-20°C~+60 °C
	NO INC.



SMART LINK 

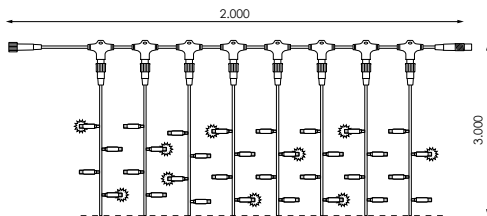













ESQUEMA INSTALACIÓN/  
INSTALLATION SCHEME/  
SCHEMA D'INSTALLATION/  
ESQUEMA DE INSTALAÇÃO



+

Producto/Product  
Produit/Produto

	2x3m
	20 (2 tiras = 1 serie)
	600
	26+4 flashing
<b>W</b>	45W
	7sets

		
441674		
441681		



+ INFO PAG. 372 **Accesorios/Accessories/Accessoires/Acessórios**

192606

Cable alimentación Transparente

# ICICLE<sup>®</sup> 114

SMART LINK 



Brenes -  
Sevilla

 230V dc

 CII











 1 CANAL





 IP20

 -20°C~+60 °C

 NO INC.



		
192613		
192637		
546553		
546560		

	<b>3x0,5m</b> (1,5m x 2seg)
	<b>2</b>
	<b>114</b>
	<b>57</b>
<b>W</b>	<b>8,2W</b>
	<b>20sets</b>

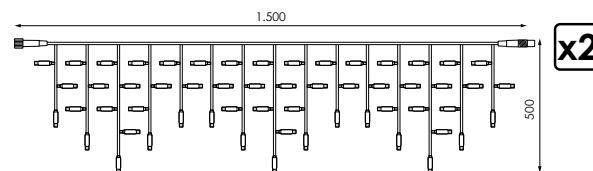

ESQUEMA INSTALACIÓN/  
INSTALLATION SCHEME/  
SCHEMA D'INSTALLATION/  
ESQUEMA DE INSTALAÇÃO



+

Producto/Product  
Produit/Produto

Accesorios/Accessories/Accessoires/Acessórios + INFO PAG. 372









192606

Cable alimentación Transparente

# ICICLE<sup>®</sup> 174

SMART LINK 

	230V dc
	CII
	1 CANAL
	IP20
	-20°C~+60 °C
	NO INC.



CC. Arturo Soria - Madrid

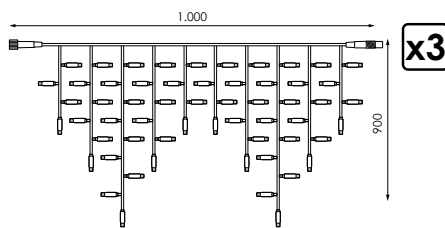













ESQUEMA INSTALACIÓN/  
INSTALLATION SCHEME/  
SCHEMA D'INSTALLATION/  
ESQUEMA DE INSTALAÇÃO



+

Producto/Product  
Produit/Produto

	3x0,9m (1m x 3seg)
	3
	174
	58
	10,5W
	15sets

		
192644		
192651		



+ INFO PAG. 372 **Accesorios/Accessories/Accessoires/Acessórios**

192606

Cable alimentación Transparente



# Accesorios

Accessories  
Accessoires  
Acessórios

		STRING <b>PLUS</b> 180	STRING <b>PLUS</b> 180 FLASHING	Cluster Light FALL LITE	SCREENLIGHT FLASHING	ICICLE®
⏏	192606	•	•		•	•
	193061			•		
	193078			•		
Ⓢ	192323			•		
	192347			•		
	192354			•		
	192361			•		
	192378			•		
	192385			•		
	192392			•		
	192408			•		
	192415			•		
	192422			•		
	192439			•		
	192446			•		
	388368			•		
	388375			•		
	388382			•		
	388399			•		
	388498			•		
	388504			•		
	391498			•		
	391504			•		

## CABLE ALIMENTACIÓN SMART LINK

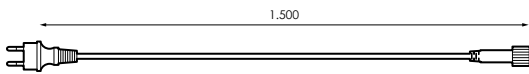

193061



230Vac

Max. 480W

CII

IP44 Plug

IP65 Conector

193078



230Vac

Max. 480W

CII

IP44 Plug

IP65 Conector

## CABLE ALIMENTACIÓN SMART LINK

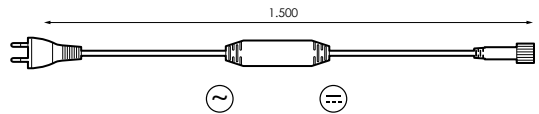

192606



230Vac

Max. 480W

CII

IP20

## CONECTOR T SMART LINK

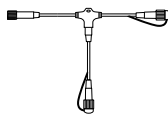

192446



IP65

192439



IP65

## CONECTOR X SMART LINK

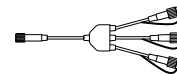

391504



IP65

391498



IP65

### CONECTOR 5 SMART LINK

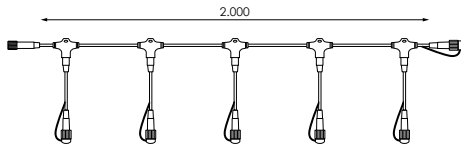

Barcode	Length	Pin Count	Shielding	IP Rating
388375	2m	5	Shielded	IP65
388368	2m	5	Unshielded	IP65

### CONECTOR 10 SMART LINK

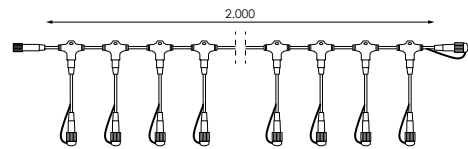

Barcode	Length	Pin Count	Shielding	IP Rating
388399	2m	10	Shielded	IP65
388382	2m	10	Unshielded	IP65

### CONECTOR 10 SMART LINK

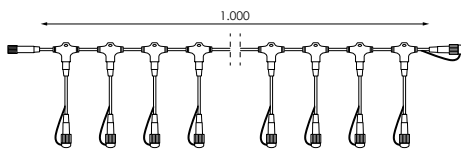

Barcode	Length	Pin Count	Shielding	IP Rating
192408	1m	10	Shielded	IP65
192392	1m	10	Unshielded	IP65

### CONECTOR 20 SMART LINK

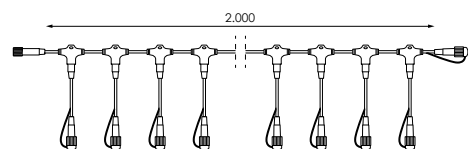

Barcode	Length	Pin Count	Shielding	IP Rating
192422	2m	20	Shielded	IP65
192415	2m	20	Unshielded	IP65

### EXTENSIÓN SMART LINK

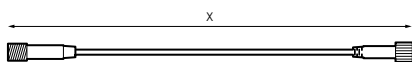

Barcode	Length	Shielding	IP Rating
388498	0,5m	Shielded	IP65
388504	0,5m	Unshielded	IP65
192347	1m	Shielded	IP65
192323	1m	Unshielded	IP65
192361	3m	Shielded	IP65
192354	3m	Unshielded	IP65
192385	5m	Shielded	IP65
192378	5m	Unshielded	IP65

**deco**

---





# Cluster

## MICROLED



	6V
	CIII
	IP20
	-20°C~+60 °C
	INC.

444354		



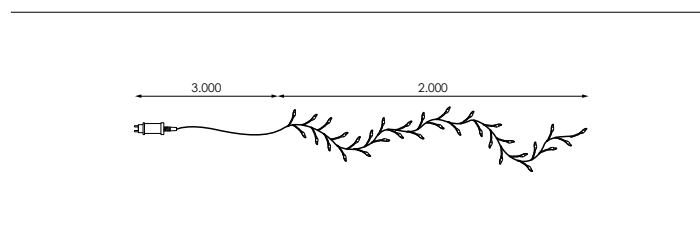



	2m
	280
<b>W</b>	5W
	NO Empalmable

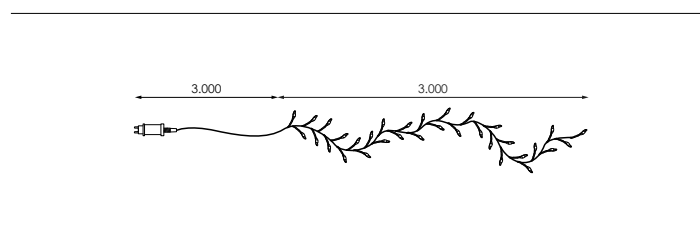





444361		



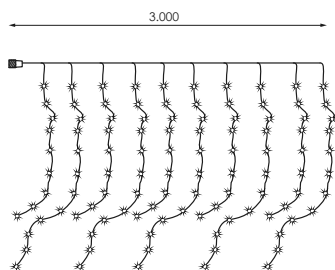

	3m
	420
<b>W</b>	6W
	NO Empalmable



	24V
	CIII
	IP20
	-20°C~+60 °C
	NO INC.
	NO INC.



	3x1m
	360
<b>W</b>	6W
	4sets

		
444439		

ESQUEMA INSTALACIÓN/  
INSTALLATION SCHEME/  
SCHEMA D'INSTALLATION/  
ESQUEMA DE INSTALAÇÃO



+ INFO PAG. 434 **Accesorios/Accessories/Accessoires/Acessórios**

<b>444446</b>
Transformador 25W

<b>447720</b>
Extensión

# Branch Tree



	6V
	CIII
	IP20
	-20°C~+60 °C
	INC.



192767		
192781		
192729		

	3m
	10
	300
<b>W</b>	6W
	<b>NO Empalmable</b>

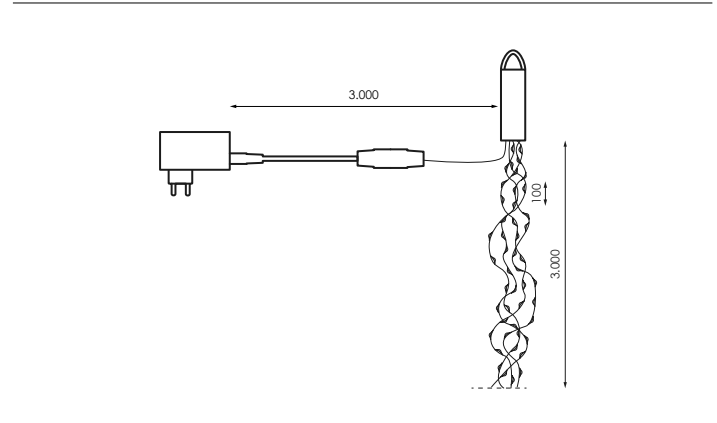



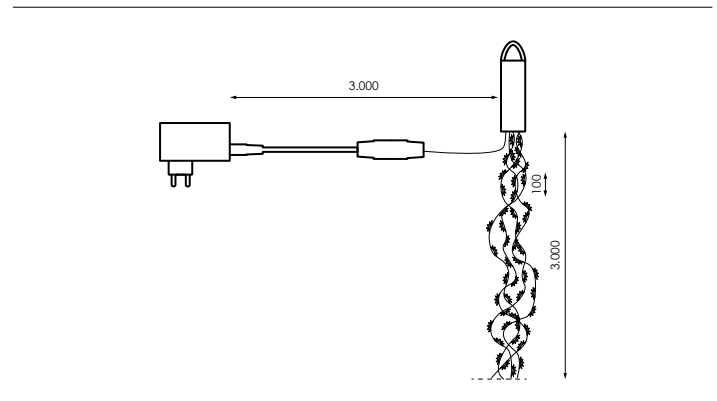

192798		



	3m
	10
	300 flashing
<b>W</b>	6W
	<b>NO Empalmable</b>



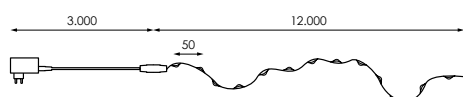
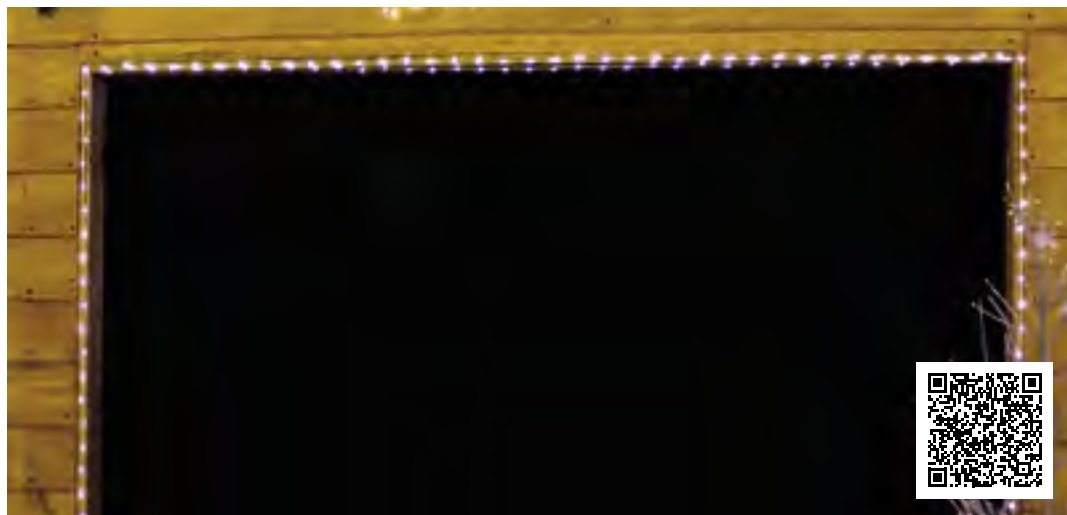

# Branch String





	6V
	CIII
	IP20
	-20°C~+60 °C
	INC.







	12m
	216
<b>W</b>	6W
	NO Empalmable

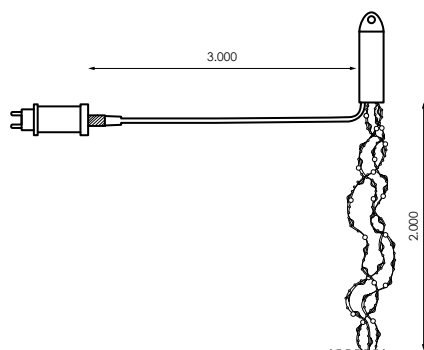
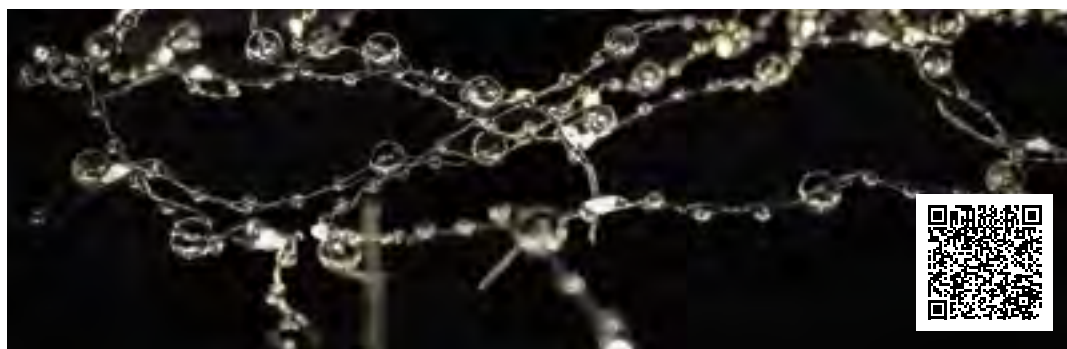

		
192705		

# Branch Crystal

	4.5V
	CIII
	IP20
	-20°C~+60 °C
	INC.



	2m
	200
<b>W</b>	6W
	NO Empalmable

		
444477		

# Solar String















 CIII

 IP44

**N/ 2 Funciones: Fija y flashing.**  
**E/ 2 Functions: Fixed and flashing.**  
**F/ 2 Fonctions: Fixes et clignotants.**  
**P/ 2 Funções: Fixos e intermitentes.**





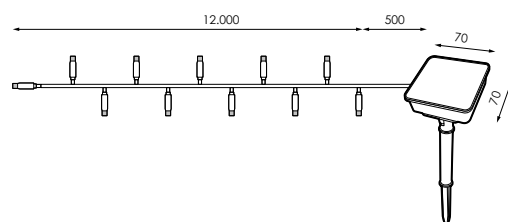

		
391177		
391160		

	12m
	0,24W 2V/120mA
	1,2V/600mA
	8h/carga
	NO Empalmable







# LED Fireworks



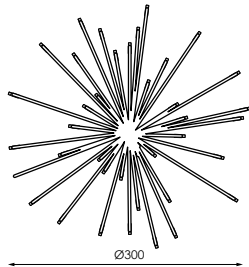

	24V
	CIII
	IP44
	-20°C~+60 °C
	INC. 3m







Canarias



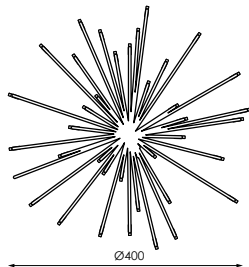









	Ø30cm
	80
<b>W</b>	6,7W
	<b>NO Empalmable</b>
Transformador <b>INCLUIDO</b> Transformer <b>INCLUDED</b> Transformateur <b>INCLUS</b> Transformador <b>INCLUIDO</b>	



		
240789		





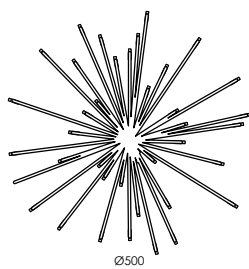







	Ø40cm
	120
<b>W</b>	11W
	<b>NO Empalmable</b>
Transformador <b>INCLUIDO</b> Transformer <b>INCLUDED</b> Transformateur <b>INCLUS</b> Transformador <b>INCLUIDO</b>	



		
240796		
441759		
441780		
441810		





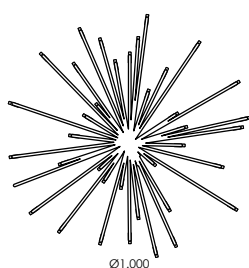







	Ø50cm
	240
<b>W</b>	21,5W
	<b>NO Empalmable</b>
Transformador <b>INCLUIDO</b> Transformer <b>INCLUDED</b> Transformateur <b>INCLUS</b> Transformador <b>INCLUIDO</b>	

		
441735		
441766		
441797		
441827		



	Ø100cm
	480
<b>W</b>	31,4W
	<b>NO Empalmable</b>
Transformador <b>INCLUIDO</b> Transformer <b>INCLUDED</b> Transformateur <b>INCLUS</b> Transformador <b>INCLUIDO</b>	

		
441742		
441773		
441803		
441834		

# Nesso



	100-240V
	CII
	IP44 (Area Ventilador)
	IP65 (Proyector)
	INC.

	W		$\phi$	$\Delta$
548335	60W		3.000lm	22°
548342	100W		7.000lm	22°

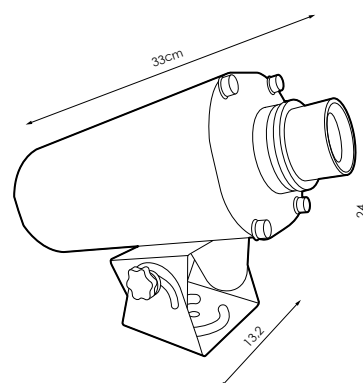
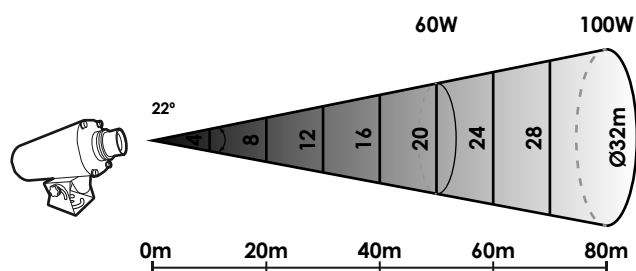

## Aviso/Warning/Avertissement/Aviso



**N**/ Pérdida del efecto luminoso por contaminación lumínica.

**E**/ Loss of the luminous effect due to light pollution.

**F**/Perte de l'effet lumineux dû à la pollution lumineuse.

**P**/Perda do efeito luminoso devido à poluição luminosa.

## Información/Information/Information/Informações



**N**/ Posibilidad de diseño a medida en la proyección bajo consulta.

**E**/ Possibility of custom design in the projection on request.

**F**/ Possibilité de conception personnalisée dans la projection sur demande.

**P**/ Possibilidade de design personalizado na projeção a pedido.



# Nesso

## STEADY

 220-240V



 CII

 IP44 (Area Ventilador)

 IP65 (Proyector)

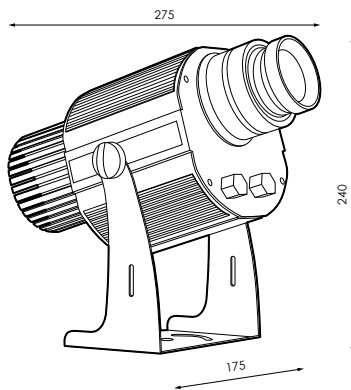
 INC.



	<b>W</b>		$\phi$	$\Delta$
513272	60W		3.000lm	18°

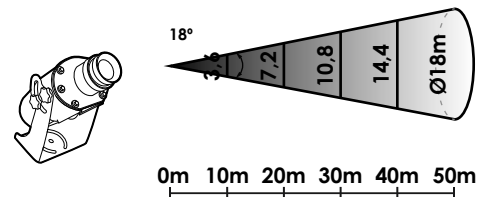

### Aviso/Warning/Avertissement/Aviso

**N**/ Pérdida del efecto luminoso por contaminación lumínica.

**E**/ Loss of the luminous effect due to light pollution.

**F**/Perte de l'effet lumineux dû à la pollution lumineuse.

**P**/Perda do efeito luminoso devido à poluição luminosa.



### Información/Information/Information/Informações

**N**/ Posibilidad de diseño a medida en la proyección bajo consulta.

**E**/ Possibility of custom design in the projection on request.

**F**/ Possibilité de conception personnalisée dans la projection sur demande.

**P**/ Possibilidade de design personalizado na projeção a pedido.

# Giro Snowflake



Fundació Catalonia -  
San Cugat del Vallés

 12V

 CIII

 IP67

 INC. 5m

**N/ Recomendable** para distancias a pared que no excedan los **8m**.  
**E/ Suitable** for wall distances not exceeding **8m**. **F/ Convient** pour des distances de paroi ne dépassant pas **8m**. **P/ Adequado** para distâncias de parede não superior a **8m**.



**W** 8W

392129



392136

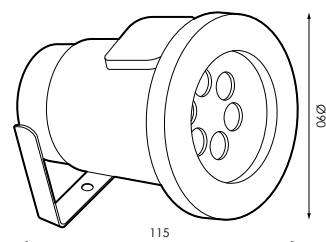

# Retail

Magnetismo Visual



En Prilux somos especialistas en la decoración e iluminación de espacios RETAIL como escaparates, tiendas, sets, corners... que convierte tu negocio en el foco de todas las miradas.

At Prilux we are specialists in the decoration and lighting of RETAIL spaces such as shop windows, shops, sets, corners ... that turns your business into the focus of all eyes.

A Prilux nous sommes spécialisés dans la décoration et l'éclairage des espaces RETAIL tels que: les vitrines des magasins, des magasins, des ensembles, des coins ... qui transforme votre entreprise dans le foyer de tous les yeux.

No Prilux somos especialistas na decoração e iluminação de espaços RETAIL: como vitrines, lojas, jogos, cantos ... que transforma o seu negócio para o foco de todas as atenções.

# Willow Light

1m

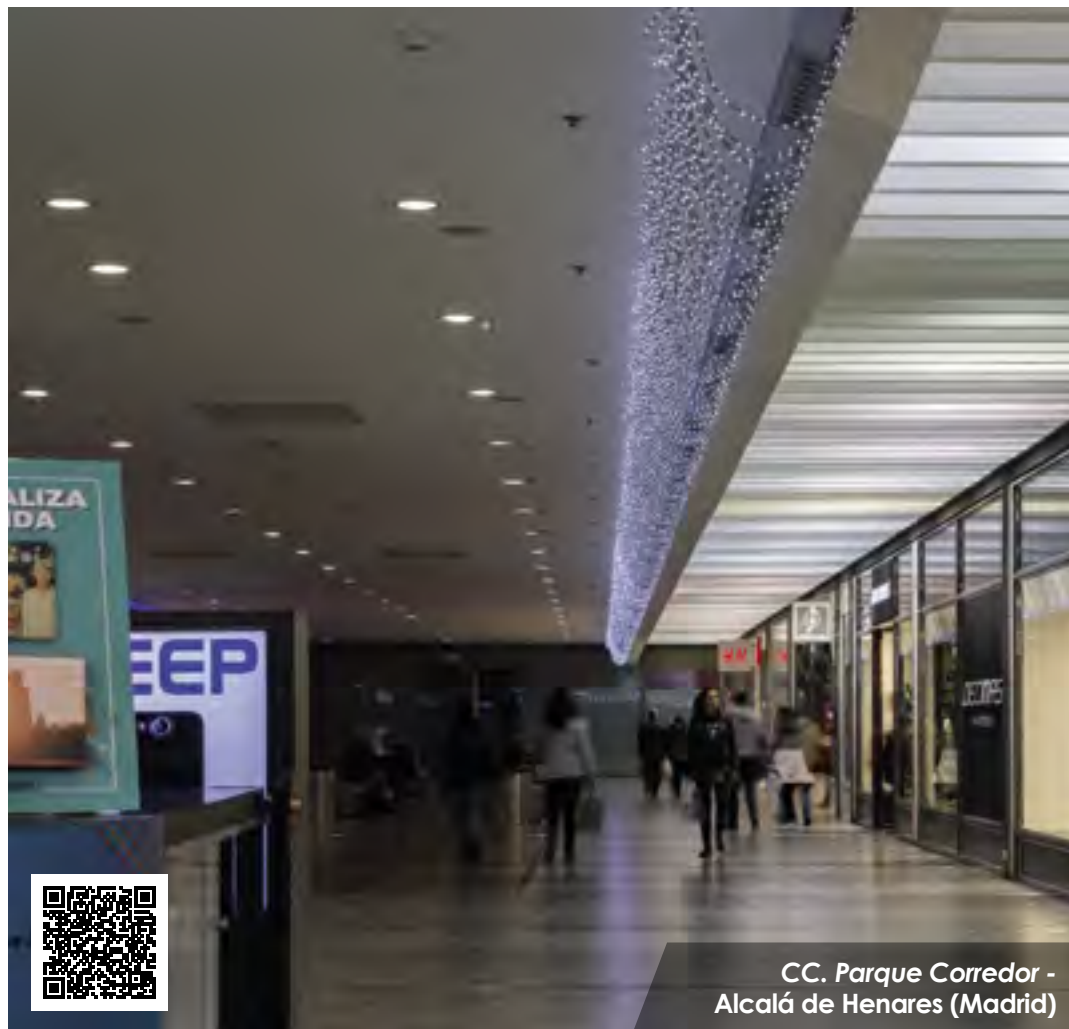

CC. Parque Corredor -  
Alcalá de Henares (Madrid)



24V

CIII

IP44

INC. 6,2m



391399		
391405		

	1m
	40
	640
<b>W</b>	59,3W
	<b>NO Empalmable</b>

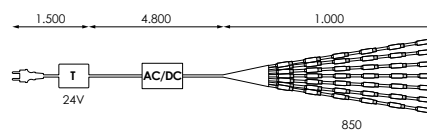

Accesorios/Accessories/Accessoires/Acessórios + INFO PAG. 434



401388

Soporte de pared

# Willow Light

1,8m

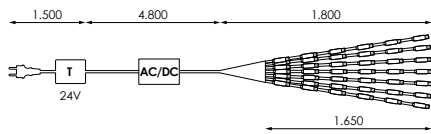
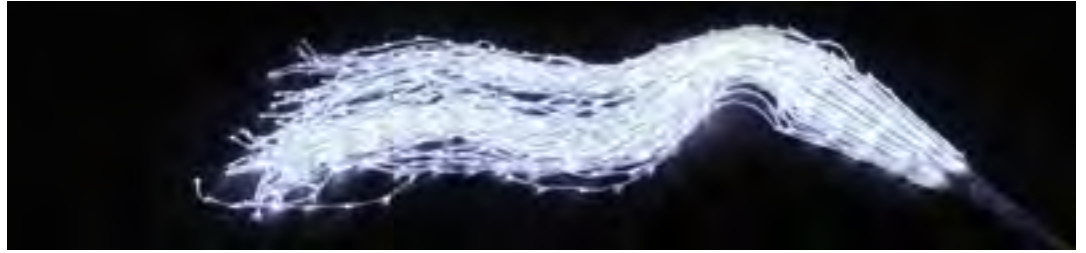

	1,8m
	40
	1.280
<b>W</b>	77,7W
	<b>NO Empalmable</b>

391412		
391429		



+ INFO PAG. 434 **Accesorios/Accessories/Accessoires/Acessórios**

401388

Soporte de pared

# Willow Light

3m

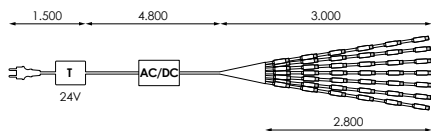

	3m
	40
	2.240
<b>W</b>	90,1W
	<b>NO Empalmable</b>

391443		



+ INFO PAG. 434 **Accesorios/Accessories/Accessoires/Acessórios**

401388

Soporte de pared

# LED Fountain



	24V
	CIII
	IP44
	INC.

Ñ/ Transformador efecto cascada **INCLUIDO** (4 velocidades y fijo).  
 E/ Transformer waterfall effect **INCLUIDE** (4-speed and fixed).  
 F/ Transformateur cascade d'effet **INCLUS** (4 vitesses et une fixe).  
 P/ Transformador cachoeira de efeito **INCLUIDO** (4-speed e fixo).



192811		
192828		

	1,5m
	Ø70cm
	1.584
<b>W</b>	42,96W
	<b>NO Empalmable</b>

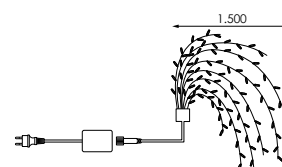

Accesorios/Accessories/Accessoires/Acessórios + INFO PAG. 434



401371

Soporte de pared

# Deco Branch

⚡ 24V

⚡ CIII

☂ IP44

TR INC.

**N**/ Posibilidad de separar la rama en 2 partes. **E**/ Possibility of separating the branch into 2 parts.  
**F**/ Possibilité de séparer la branche en 2 parties. **P**/ Possibilidade de separar a filial em 2 partes.



[GRÁFICOS: Unidades en mm/ GRAPHICS: Units in mm/ GRAPHIQUES: Unités en mm/ GRÁFICOS: Unidades em mm]

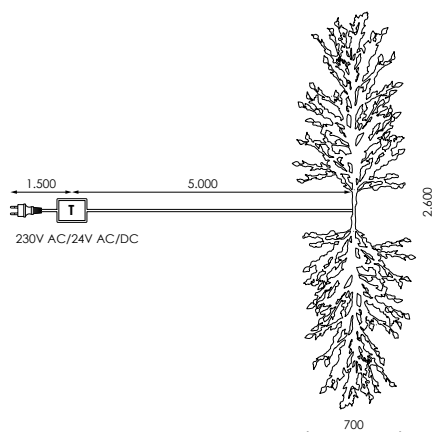

2,6x0,7m



600



48W



**NO**  
Empalmeable



953634

**N** 512909



LED

LED



# Branch LED



⚡ 24V dc

◊ CIII

° IP44

TR INC.



Almonte -  
Huelva

961998		
962001		
192866		
192873		

	3,6m
	288
<b>W</b>	16W
	<b>NO Empalmable</b>

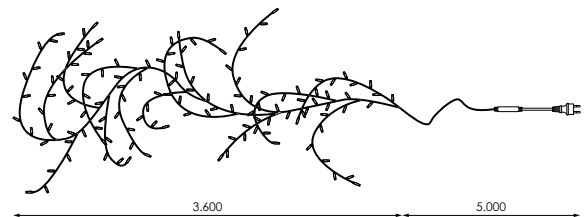



⚡ 24V

⬠ CIII

☂ IP44

TR INC. 3m

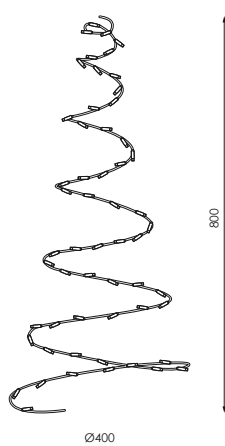
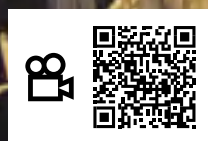

Ø40x80cm



120



5,8W



**NO**  
Empalmable



210522



LED



# Snow Tree



CC. Alhambra - Ecuador

⚡ 24V ac

☐ CII

🌡️ IP20

TR INC. 3m





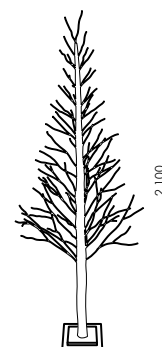

	💡	∞
414739	LED	■



↕	2,1m
💡	306
W	12W
🚫	NO Empalmable





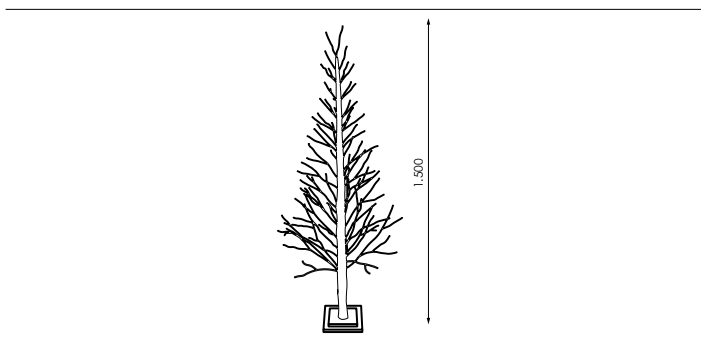

# Golden Tree



	24V ac
	CII
	IP20
	INC. 3m





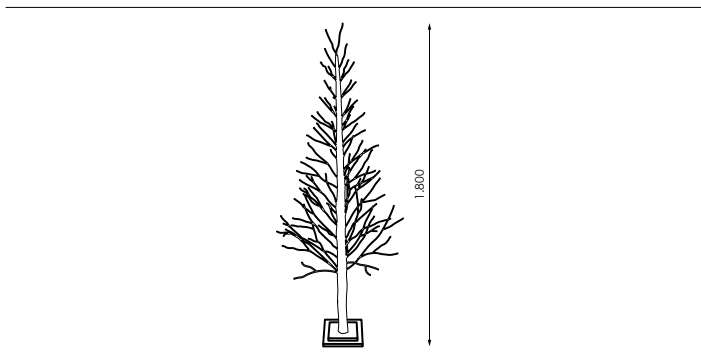

	1,5m
	186
<b>W</b>	7,2W
	<b>NO Empalmable</b>



		
414746		





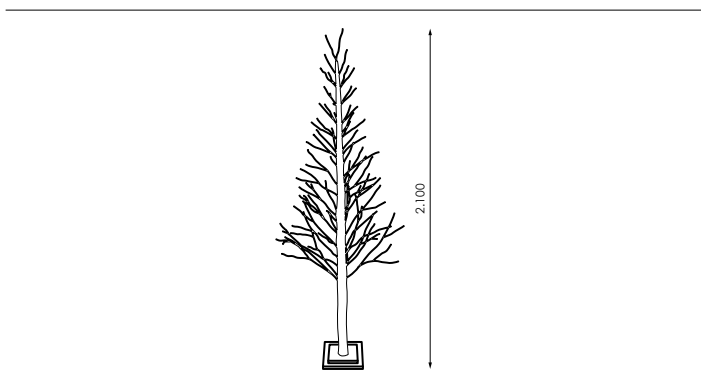

	1,8m
	270
<b>W</b>	9,6W
	<b>NO Empalmable</b>

		
414753		



	2,1m
	306
<b>W</b>	12W
	<b>NO Empalmable</b>

		
414760		

# Willow Tree



⚡ 24V ac

☐ CII

° IP20

TR INC. 3m

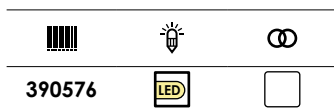

390576

LED



↕	1,2m
💡	66
W	2,64W
⊗	NO Empalmbale



# Winter Tree



⚡ 24V

◊ CIII

° IP44

TR INC. 5m

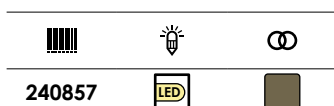

240857

LED



↕	1,8m
💡	96
W	3,6W
⊗	NO Empalmbale

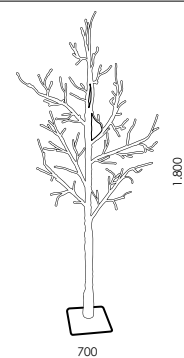

# Birch Tree

⚡ 24V ac

☐ CII

⊙ IP20

TR INC. 3m

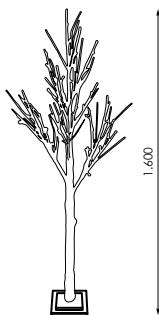

1,6m



54

**W**

2,16W



**NO  
Empalmable**



390866

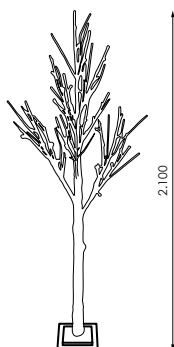

2,1m



90

**W**

3,6W



**NO  
Empalmable**





390873



# Green Christmas Tree





	
977425	150cm
977432	180cm
977449	210cm



# Snowy Christmas Tree



	
977456	150cm
977463	180cm
977470	210cm





# Ball 3D

## MICROLED



 24V





 CIII



 IP44

 INC. 3m









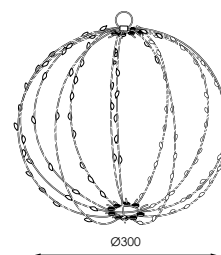

Fundació Catalonia -  
San Cugat del Vallés

		
444392		

	Ø30cm
	120
<b>W</b>	1,35W
	NO Empalmable



		
444408		

	Ø40cm
	180
<b>W</b>	6W
	NO Empalmable

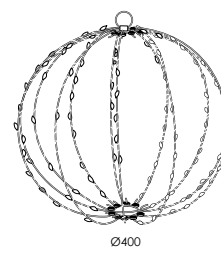



# Star Gold Line 3D

⚡ 4,6V

⚡ CIII

☂ IP20

TR INC. 5m



Canarias

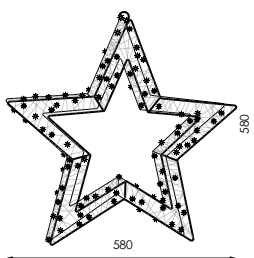

↕ 58x58x8cm

💡 160

W 1,35W

⚡ NO Empalmable

🏠 Interior Indoors

||||| 💡 ☉

444484 LED

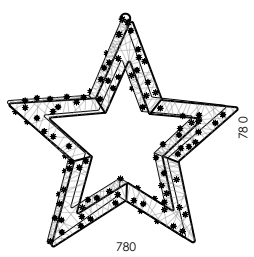

↕ 78x78x12cm

💡 240

W 1,35W

⚡ NO Empalmable

🏠 Interior Indoors

||||| 💡 ☉

444491 LED

# Star Flat



⚡ 4,5V

⚡ CIII

🌡️ IP20

📏 TR INC. 3m

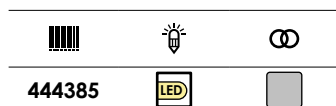

444385



↕ 50x50cm

💡 60

W 1,35W

🚫 NO Empalmable

🏠 Interior Indoors

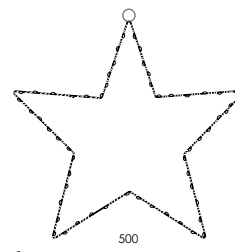

# Star Copper



⚡ 24V

⚡ CIII

🌡️ IP20

📏 TR INC. 5m

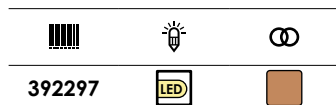

392297



↕ 25x25cm

💡 15

W 3W

🚫 NO Empalmable

🏠 Interior Indoors

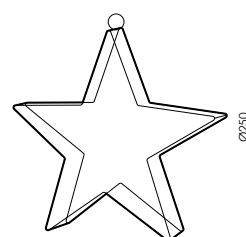

# Star Glass Balls

⚡ 3,2V

⬠ CIII

⦿ IP20

TR INC. 3m



∅ Ø13cm

⦿ 1

💡 15

W 0,96W

⊗ NO Empalmable

🏠 Interior Indoors



444521



LED

# Cluster Glass Balls

⚡ 3,2V

⬠ CIII

⦿ IP20

TR INC. 3m

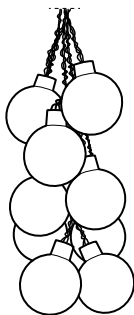

∅ Ø8cm

⦿ 10

W 0,96W

⊗ NO Empalmable

🏠 Interior Indoors



444538



LED

# Cotton Balls



	3,2V
	CIII
	IP20
	INC. 3m

444507		

	Ø6cm
	10
<b>W</b>	0,64W
	NO Empalmable
	Interior Indoors

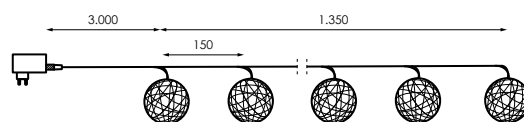



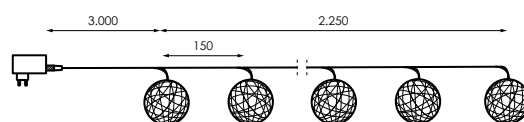

444514		





	Ø6cm
	16
<b>W</b>	0,64W
	NO Empalmable
	Interior Indoors



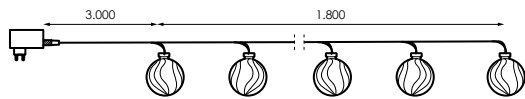

# Glass Balls Chain





	3,2V
	CIII
	IP20
	INC. 3m









	Ø6cm
	10
	0,96W
	NO Empalmable
	Interior Indoors

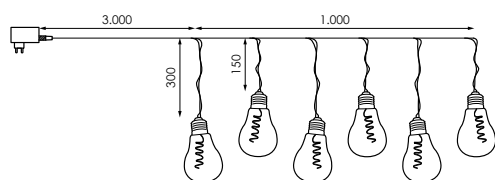

	
444552	

# EsSense Plastic Balls

	3,2V
	CIII
	IP20
	INC. 3m



	Ø9cm
	6
	0,96W
	NO Empalmable
	Interior Indoors

	
444545	

# Spike Star

Producto  
Product  
Produit  
Produto

3D

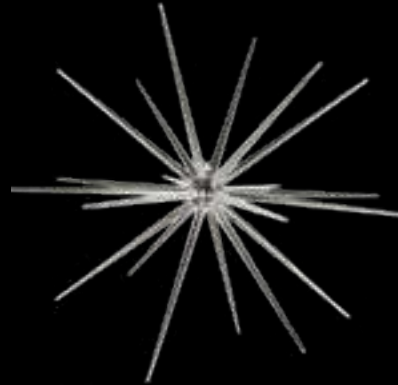

392181		60cm
392198		60cm



Interior  
Indoors

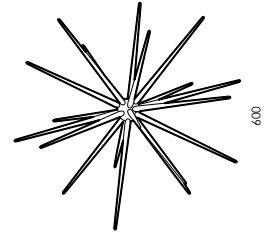

# Glitter Star

Producto  
Product  
Produit  
Produto

3D



389143		30cm
389198		60cm



Interior  
Indoors

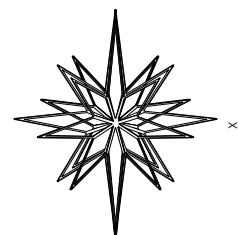

# Glitter Loop

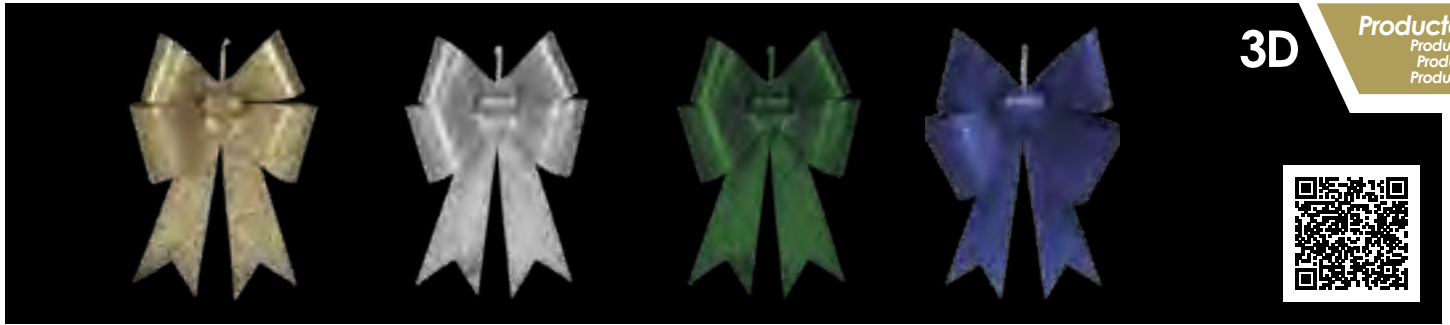

3D

Producto  
Product  
Produit  
Produto

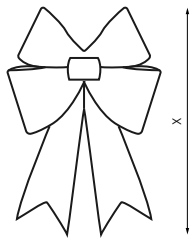

Interior  
Indoors



389259		46cm
389273		46cm
414777		46cm
414791		46cm
389228		76cm
389242		76cm
414784		76cm
414807		76cm

# Candy Cane



3D

Producto  
Product  
Produit  
Produto

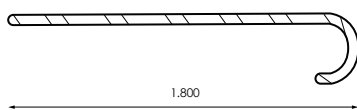

180x7,5x46cm



Interior  
Indoors



389129

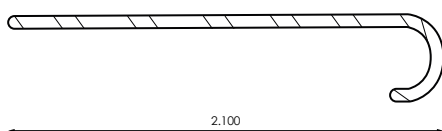

210x7,5x46cm



Interior  
Indoors



389112



# Ocean Comet

Producto  
Product  
Produit  
Produto

3D



	24V
	CIII
	IP20
	INC. 3m

240734		

	55x67cm
	24
<b>W</b>	1,44W
	NO Empalmable
	Interior Indoors
	Para suspender To suspend

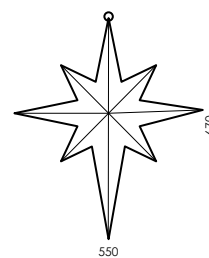

# Ocean Star

Producto  
Product  
Produit  
Produto

3D



	24V
	CIII
	IP20
	INC. 3m

240741		

	40x40cm
	24
<b>W</b>	1,44W
	NO Empalmable
	Interior Indoors
	Para suspender To suspend

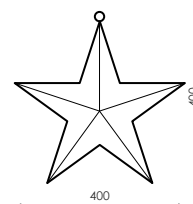



# Ocean Cone

⚡ 24V

⚡ CIII

⊙ IP20

TR INC. 3m

3D

Producto  
Product  
Produit  
Produto

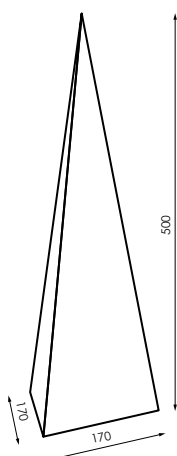

50x17x17cm



16



0,96W



NO  
Empalmable



Interior  
Indoors



240758



LED



# Elegant Cone

Producto  
Product  
Produit  
Produto

3D

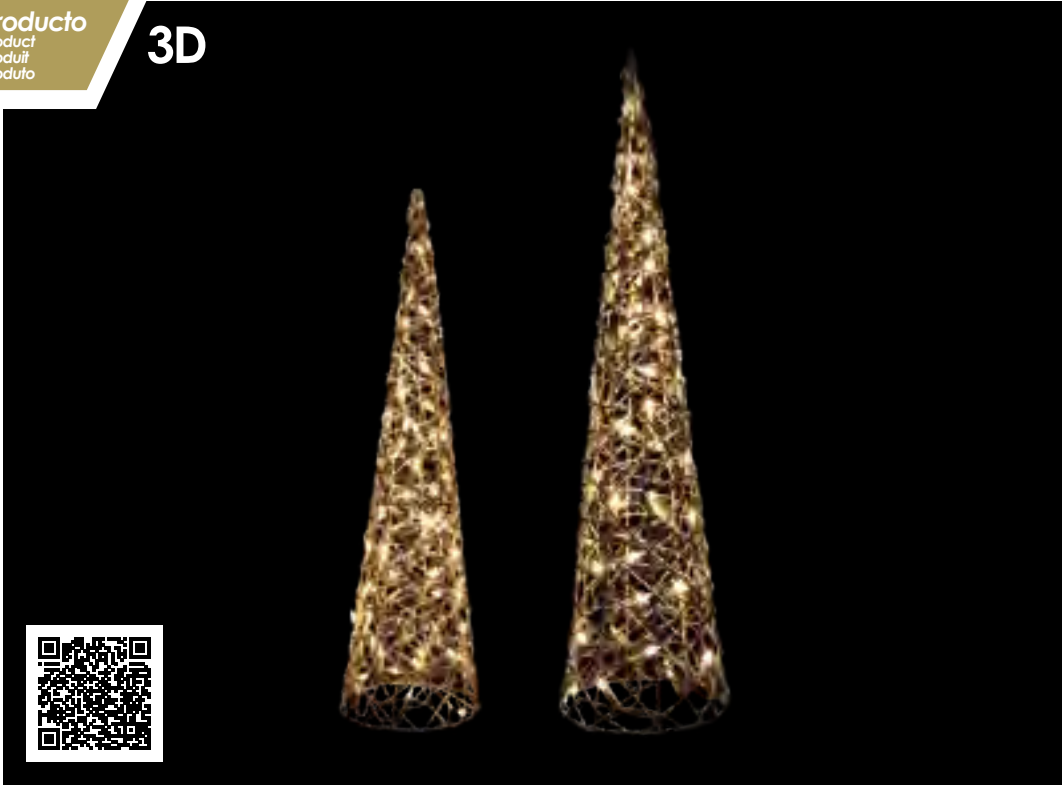

⚡ 31V

◊ CIII

⊙ IP44

TR INC.

547819		

	80x20x20cm
	40
<b>W</b>	3,6W
	NO Empalmable
	Interior Indoors

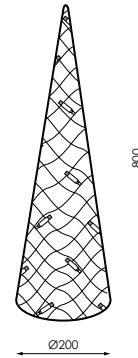



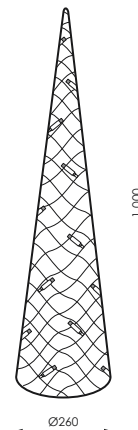

547826		

	100x26x26cm
	70
<b>W</b>	3,6W
	NO Empalmable
	Interior Indoors



# Elegant Gift







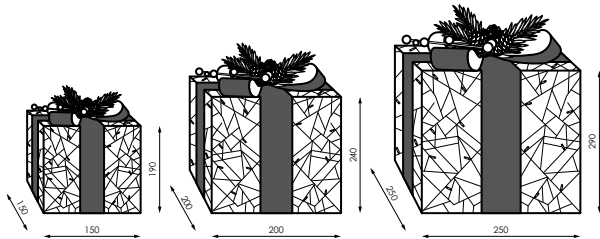

	31V
	CIII
	IP44
	INC.



3D





Producto  
Product  
Produit  
Produto



	10/20/35			
<b>W</b>	3,6W	547802		
	NO Empalmable			
	Interior Indoors			

# Elegant Deer

53cm







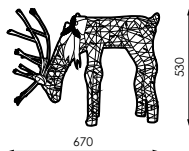

	31V
	CIII
	IP44
	INC.



3D

Producto  
Product  
Produit  
Produto



	53x67x23cm			
	80	547833		
<b>W</b>	3,6W			
	NO Empalmable			
	Interior Indoors			

# Elegant Deer

77cm

Producto  
Product  
Produit  
Produto

3D



	31V
	CIII
	IP44
	INC.

547840		

	77x50x16cm
	80
<b>W</b>	3,6W
	NO Empalmable
	Interior Indoors



# Elegant Deer

154cm

Producto  
Product  
Produit  
Produto

3D



	31V
	CIII
	IP44
	INC.



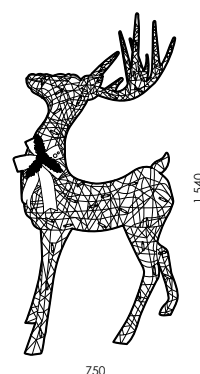

547857		

	154x75x58cm
	150
<b>W</b>	3,6W
	NO Empalmable
	Interior Indoors



# Elegant Deer

132cm

	31V
	CIII
	IP44
	INC.







Nuevo  
New  
Nouveau  
Novo



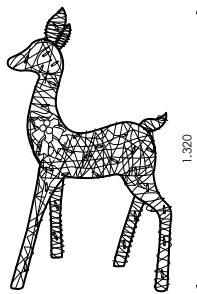

N

3D





Producto  
Product  
Produit  
Produto



	132cm
	240
<b>W</b>	3,6W
	NO Empalmable
	Interior Indoors

		
563291	LED	

# Glaciar Deer Set



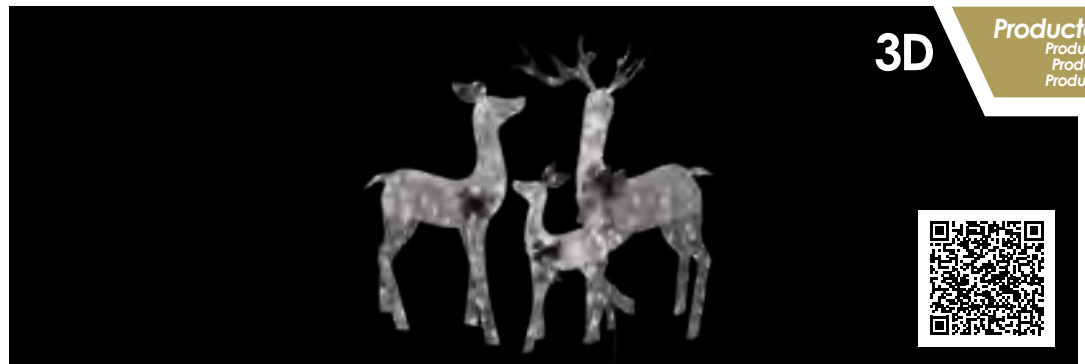

	31V
	CIII
	IP44
	INC.



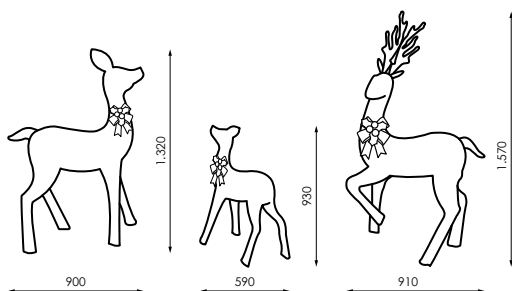



3D

Producto  
Product  
Produit  
Produto















	Ver gráfico
	150/120/80
<b>W</b>	12W
	NO Empalmable
	Interior Indoors





		
507097	LED	

# Christmas Balls







		
		
	Ø20cm	193108
	Ø10cm	543620
	Ø15cm	543804
	Ø20cm	543989
	Ø10cm	543613
	Ø15cm	543798
	Ø20cm	543972
	Ø7cm	972512
	Ø10cm	972574
	Ø12cm	972635
	Ø15cm	972697
	Ø20cm	972758
	Ø7cm	979221
	Ø10cm	979238
	Ø15cm	979245
	Ø20cm	979252
	Ø30cm	979269
	Ø7cm	410878
	Ø10cm	411011
	Ø15cm	411097
	Ø20cm	411127
	Ø10cm	998093
	Ø15cm	998109
	Ø20cm	998116
	Ø10cm	543750
	Ø15cm	543934
	Ø20cm	544115
	Ø10cm	543743
	Ø15cm	543927
	Ø20cm	544108





# Christmas Balls

		
	Ø7cm	543422
	Ø10cm	543606
	Ø15cm	543781
	Ø20cm	543965





Granate Glitter  
Garnet Glitter  
Grenat Glitter  
Granada Glitter

		
	Ø7cm	543408
	Ø10cm	543583
	Ø15cm	543767
	Ø20cm	543941





Oro Glitter  
Gold Glitter  
Or Glitter  
Ouro Glitter

		
	Ø7cm	972499
	Ø10cm	972550
	Ø15cm	972673
	Ø20cm	972734
	Ø30cm	972826





Granate Brillo  
Garnet Shiny  
Grenat Brillor  
Granada Brilho

		
	Ø7cm	972468
	Ø10cm	972529
	Ø15cm	972642





Oro Brillo  
Gold Shiny  
Or Brillor  
Ouro Brilho

		
	Ø7cm	972505
	Ø10cm	972567
	Ø15cm	972680
	Ø20cm	972741
	Ø30cm	972833





Granate Mate  
Garnet Matt  
Grenat Mat  
Granada Matt

		
	Ø7cm	972475
	Ø10cm	972536
	Ø15cm	972659
	Ø20cm	972710
	Ø30cm	972819

Oro Mate  
Gold Matt  
Or Mat  
Ouro Matt

		
	Ø10cm	543736
	Ø15cm	543910
	Ø20cm	544092





Negro Glitter  
Black Glitter  
Noir Glitter  
Preto Glitter

		
	Ø7cm	543545
	Ø10cm	543729
	Ø15cm	543903
	Ø20cm	544085





Negro Mate  
Black Matt  
Noir Mat  
Preto Matt

# Christmas Balls







		
		
	Ø7cm	543415
	Ø10cm	543590
	Ø15cm	543774
	Ø20cm	543958





Plata Glitter  
Silver Glitter  
Argent Glitter  
Prata Glitter

		
		
	Ø10cm	543712
	Ø15cm	543897
	Ø20cm	544078





Olive Glitter  
Olive Glitter  
Olive Glitter  
Olive Glitter

		
		
	Ø7cm	972482
	Ø10cm	972543
	Ø15cm	972666
	Ø20cm	972727





Plata Brillo  
Silver Shiny  
Argent Briller  
Prata Brilho

		
		
	Ø10cm	543699
	Ø15cm	543873
	Ø20cm	544054

Olive Brillo  
Olive Shiny  
Olive Briller  
Olive Brilho

		
		
	Ø7cm	410915
	Ø10cm	411042
	Ø15cm	411103
	Ø20cm	411110

Plata Mate  
Silver Matt  
Argent Mat  
Prata Matt

		
		
	Ø10cm	543705
	Ø15cm	543880
	Ø20cm	544061





Olive Mate  
Olive Matt  
Olive Mat  
Olive Matt











# Christmas Balls











Brasería La Selva -  
Barcelona





		
	Rosa Glitter	543651
	Pink Glitter	543835
	Rose Glitter	544016

		
	Cobre Glitter	543682
	Copper Glitter	543866
	Cuivre Glitter	544047

		
	Rosa Brillo	543637
	Pink Shiny	543811
	Rose Briller	543996

		
	Cobre Brillo	543668
	Copper Shiny	543842
	Cuivre Briller	544023

		
	Rosa Mate	543644
	Pink Matt	543828
	Rose Mat	544009

		
	Ø7cm	543491
	Cobre Mate	543675
	Copper Matt	543859
	Cuivre Mat	544030

# Cluster Balls



Barcode	Symbol
210799	Red star, Gold star
411134	White star, Blue square
411141	Red star, Grey square
411158	Grey square, Gold star

 29x19,3cm

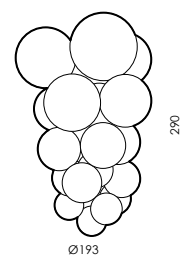

Barcode	Symbol
411165	Red star, Gold star
411172	White star, Blue square
411189	Red star, Grey square
411196	Grey square, Gold star

 36x21cm

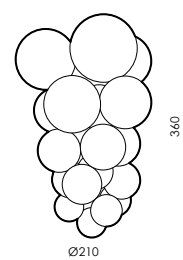

# Branch



977487



30mx60cm



977494



30mx60cm



998000



30mx60cm



997980



30mx60cm



997997



30mx60cm



157001



30mx60cm



## Información/Information/Information/Informações

**N**/ Ideal para árboles, conos gigantes y decoración de pasillos y fachadas.

**E**/ Ideal for trees, giant cones and decoration of halls and façades.

**F**/ Idéal pour les arbres, les cônes géants et décoration de salles et façades.

**P**/ Ideal para árvores, conos gigantes e decoração de paredes e fachadas.

# Tapiz Metalizado



Barcode	Color	Description
093712		Azul/Blue/Bleu/Azul
093705		Verde/Green/ Vert/ Verde
093651		Rojo/Red/Rouge/Vermelha
093675		Oro claro/Clear gold/Or clair/Limpar ouro
093743		Plata/Silver/Argent/Prata
093736		Negro/Black/Noir/Preto
962018		Blanco/White/Blanc/Branca

2500x90cm

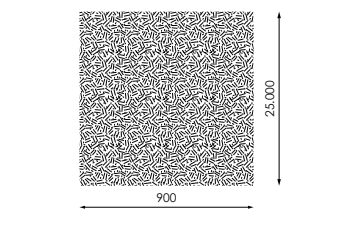

# Tapiz Tradicional

Barcode	Color	Description
061414		Verde/Green/ Vert/ Verde
061421		Blanco/White/Blanc/Branca
061438		Amarillo/Yellow/Jaune/Amarela
061445		Rojo/Red/Rouge/Vermelha
061452		Azul/Blue/Bleu/Azul
086110		Marrón/Brown/Brun/Marrom
086127		Naranja/Orange/Orange/Laranja
952842		Rosa/Pink/Rose/Rosa

2500x90cm

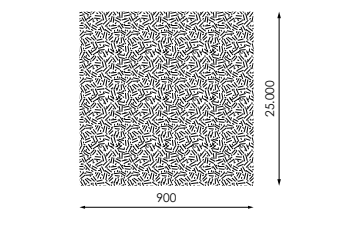

## Aviso/Warning/Avertissement/Aviso



Ñ/ NO APTO para lugares con alta concentración de niebla salina tales como zonas costeras, puertos marítimos o puertos.  
NO cubierto por la garantía bajo dichas circunstancias.

E/ NOT SUITABLE for areas with a high concentration of salt spray such as foreshores and harbours.  
NOT warranty under such circumstances.

F/ NE CONVIENT PAS pour les régions avec une forte concentration de brouillard salin tels que les estrans et les ports.  
PAS couvert par la garantie dans de telles circonstances.

P/ NÃO APROPRIADO para áreas com alta concentração de névoa salina, como costas e portos.  
NÃO cobertos pela garantia sob tais circunstâncias..



[GRÁFICOS: Unidades en mm/ GRAPHICS: Units in mm/ GRÁFICOS: Unidades em mm/ GRÁFICOS: Unidades em mm]



∅ 8cm

↕ 10m



<b>486583</b>		Dorado metálico/Gold metallic/ Or métallique/Ouro metálico
<b>486590</b>		Plata metálico/Silver metallic/ Argent métallique/Prata metálico
<b>486545</b>		Rojo metálico/Red metallic/ Rouge métallique/Vermelho metálico
<b>486576</b>		Azul metálico/Blue metallic/ Bleu métallique/Azul metálico
<b>486606</b>		Verde mate/Green matt/ Vert mat/Verde mate



∅ 12cm

↕ 10m



<b>486644</b>		Dorado metálico/Gold metallic/ Or métallique/Ouro metálico
<b>486651</b>		Plata metálico/Silver metallic/ Argent métallique/Prata metálico
<b>486613</b>		Rojo metálico/Red metallic/ Rouge métallique/Vermelho metálico
<b>486637</b>		Azul metálico/Blue metallic/ Bleu métallique/Azul metálico
<b>486668</b>		Verde mate/Green matt/ Vert mat/Verde mate

# Green Branch



507042



3mx45cm

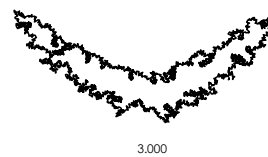

# Tapiz Net



484206



Dorado metálico/Gold metallic/  
Or métallique/Ouro metálico

484213



Plata metálico/Silver metallic/  
Argent métallique/Prata metálico

484220



Rojo metálico/Red metallic/  
Rouge métallique/Vermelho metálico

484237



Verde metálico/Green metallic/  
Vert métallique/Verde metálico

484244



Azul metálico/Blue metallic/  
Bleu métallique/Azul metálico

484251



Verde mate/Green matt/  
Vert mat/Verde mate



2500x90cm

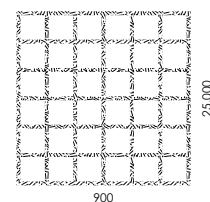

# PVC Net

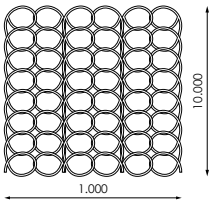
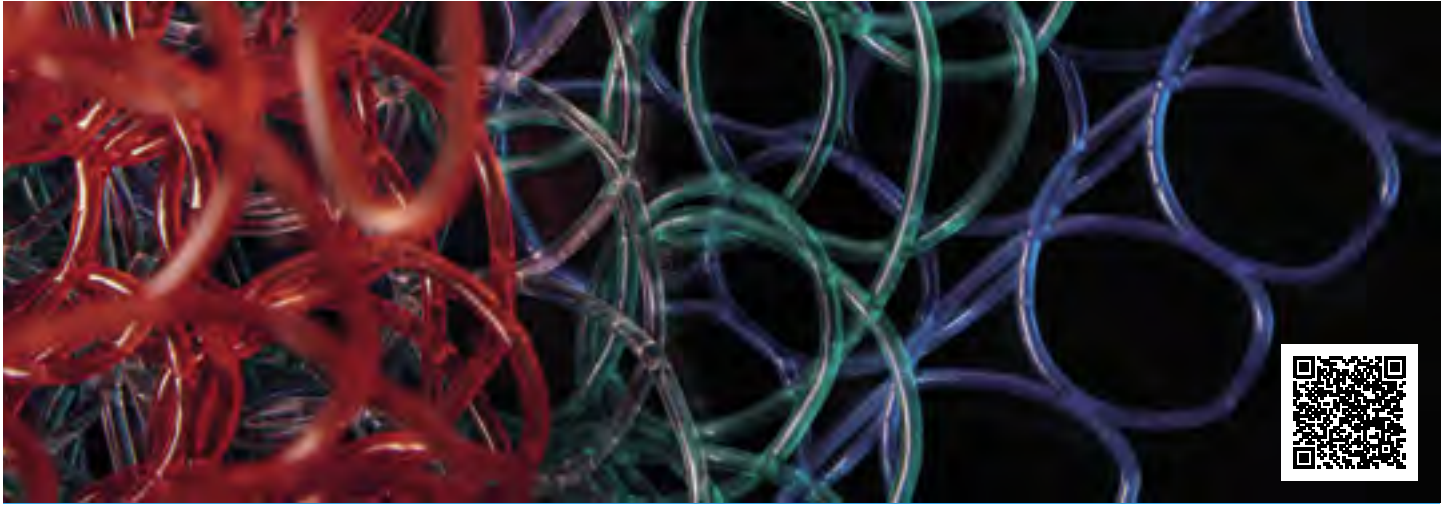

10x1m



<b>442848</b>	Transparente/Transparent/Transparente/Transparente
<b>442855</b>	Rojo/Red/Rouge/Vermelho
<b>442862</b>	Azul/Blue/Bleu/Azul
<b>442879</b>	Verde/Green/Vert/Verde

# PVC Net Glitter

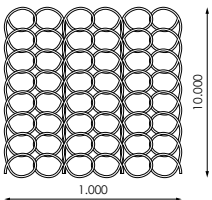

10x1m



<b>442886</b>	Dorado/Golden/D'or/Dourado
<b>442893</b>	Plata/Silver/Argent/Prata

# Fall Lite LED

SMART

SMART  
LINK 



 230V ac

 IP44

 NO INC.



487498



60cm



1,5W



144



100pc

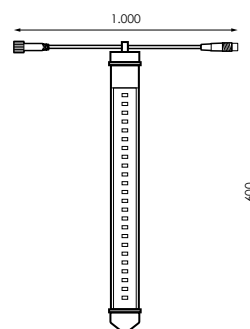

ESQUEMA INSTALACIÓN/  
INSTALLATION SCHEME/  
SCHÉMA D'INSTALLATION/  
ESQUEMA DE INSTALAÇÃO



+

Producto/Product  
Produto/Produto

Accesorios/Accessories/Accessoires/Acessórios + INFO PAG. 434



193078

Cable alimentación Blanco

Información/Information/Information/Informações



Ñ/ Este producto puede utilizar el cable de alimentación con o sin rectificador.

E/ This product can use the power cord with or without a rectifier.

F/ Ce produit peut utiliser le cordon d'alimentation avec ou sans redresseur.

P/ Este produto pode usar o cabo de alimentação com ou sem um retificador.



# Fall Lite LED SMART

SMART LINK 

 230V ac

 IP44

 NO INC.



Arcos Valdevez - Portugal

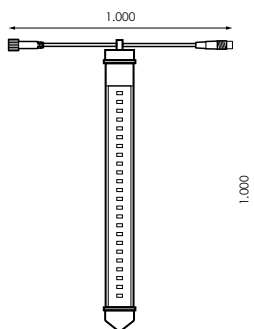
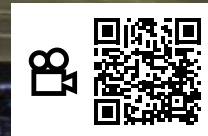

 **100cm**

 **3W**

 **192**

 **100pc**



**487504**



ESQUEMA INSTALACIÓN/  
INSTALLATION SCHEME/  
SCHEMA D'INSTALLATION/  
ESQUEMA DE INSTALAÇÃO



+

Producto/Product  
Produit/Produto



+ INFO PAG. 434 **Accesorios/Accessories/Accessoires/Acessórios**

**193078**

Cable alimentación Blanco



**Información/Information/Information/Informações**

**N/** Este producto puede utilizar el cable de alimentación con o sin rectificador.

**E/** This product can use the power cord with or without a rectifier.

**F/** Ce produit peut utiliser le cordon d'alimentation avec ou sans redresseur.

**P/** Este produto pode usar o cabo de alimentação com ou sem um retificador.



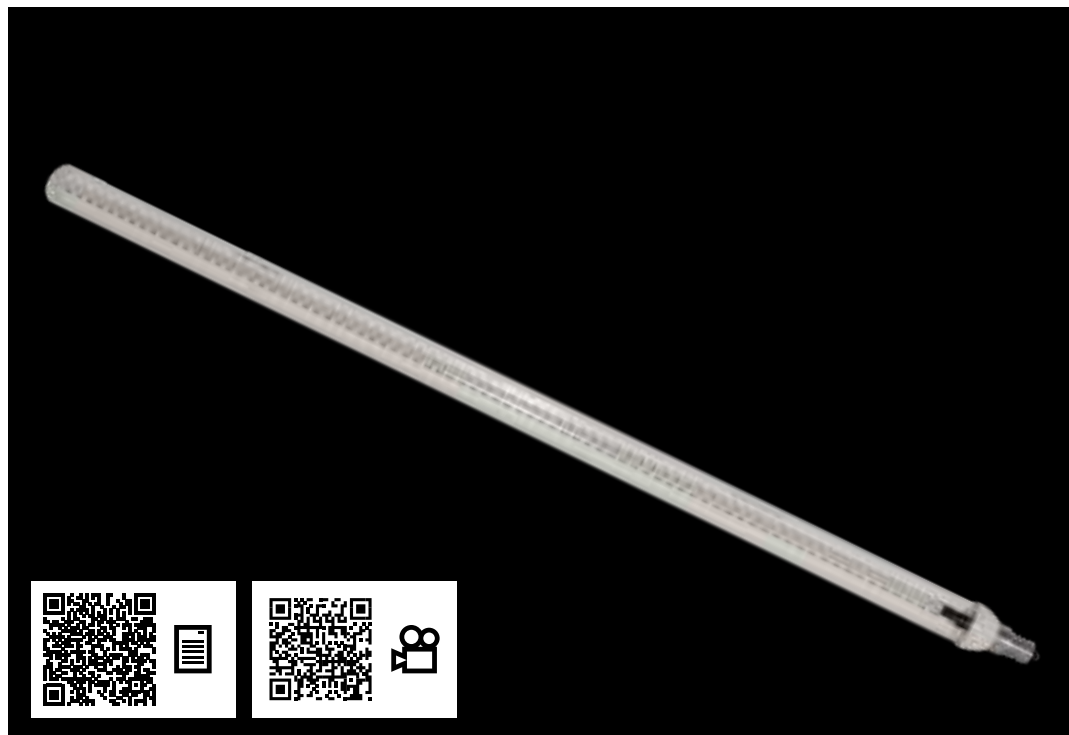

# Fall Lite LED





 230V





 IP44

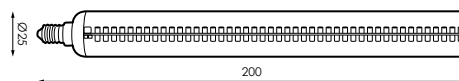

**N**/ Para portalámparas estanco.  
**E**/ For waterproof lampholder.  
**F**/ Pour la douille imperméable à l'eau.  
**P**/ Para portalâmpada impermeável.

	
391450	
543040	





	20cm
<b>W</b>	1W
	E14



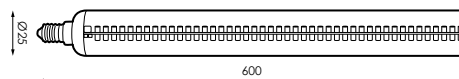

	
512916*	
543057	

	60cm
<b>W</b>	2W
	E14



	
391474	
543064	

	100cm
<b>W</b>	4W
	E14

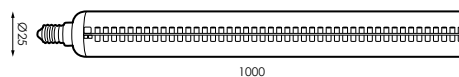

## Información/Information/Information/Informações



**N**/ \* Este producto lleva LEDs SMD.

**E**/ \* This product carries SMD LEDs.

**F**/ \* Ce produit est équipé de LED SMD.

**P**/ \* Este produto possui LEDs SMD.

# esSENSE BALL LED

 230V ac

 IP44

**N**/ Para portalámparas estanco.  
**E**/For waterproof lampholder.  
**F**/ Pour la douille imperméable à l'eau. **P**/ Para portalámpada impermeável.

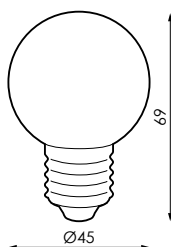

**W** 1,5W

 E27



391252



391276



391269



391290



391283



# esSENSE BALL LED

 230V ac

 IP44

**N**/ Para portalámparas estanco.  
**E**/For waterproof lampholder.  
**F**/ Pour la douille imperméable à l'eau. **P**/ Para portalámpada impermeável.



Nuevo  
 New  
 Nouveau  
 Novo **N**

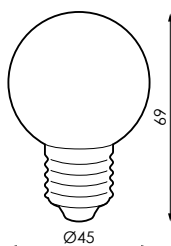

**W** 1,6W

 E27



561235



561228











# Pebetero LED



 230V ac

 IP44

**N**/ Para portalámparas estanco.  
**E**/For waterproof lampholder.  
**F**/ Pour la douille imperméable à l'eau.  
**P**/ Para portalâmpada impermeável.

	
391191*	
391184*	
391221	
391214	
391238	
391207	

<b>W</b>	<b>2W* 1W</b>
	<b>E14</b>
Cristal transparente. Transparent glass. Verre transparent. Vidro transparente.	

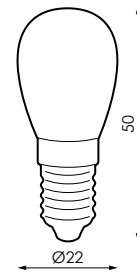

# Pebetero LED











**N** Nuevo  
 New  
 Nouveau  
 Novo



 230V ac

 IP44

**N**/ Para portalámparas estanco.  
**E**/For waterproof lampholder.  
**F**/ Pour la douille imperméable à l'eau.  
**P**/ Para portalâmpada impermeável.

	
561174	
561181	
561198	
561204	
561211	
563710	

<b>W</b>	<b>2W</b>
	<b>E14</b>
Cristal transparente. Transparent glass. Verre transparent. Vidro transparente.	

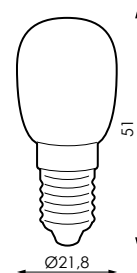



**Cuidad de Braga 2020**  
by AM Illumination  
Producto Prilux

# esSENSE Ball *LED*

basic



 230V

 IP44

**N**/ Para portalámparas estanco.  
**E**/ For waterproof lampholder.  
**F**/ Pour la douille imperméable à l'eau. **P**/ Para portalâmpada impermeável.



961240\*



**W** 1,5W

 **E27**

\*Cambio de color sincronizado entre lámparas.  
 \*Change of color sync between lamps.  
 \*Changement de synchronisation de couleur entre les lampes.  
 \*Mudança de sincronização de cor entre lâmpadas.

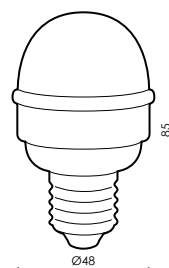

# Flash Light *LED*



 230V

 IP44

**N**/ Para portalámparas estanco.  
**E**/ For waterproof lampholder.  
**F**/ Pour la douille imperméable à l'eau. **P**/ Para portalâmpada impermeável.



389884



E14

389907



E27

389891



B22

**W** 3W

 **36**

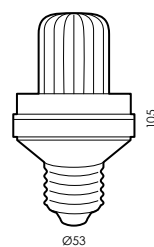

# Standard

## INCANDESCENCIA

 230V ac

 IP44

**N**/ Para portalámparas estanco.  
**E**/For waterproof lampholder.  
**F**/ Pour la douille imperméable à l'eau. **P**/ Para portalámpada impermeável.

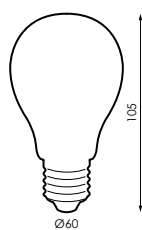

**W** 15W



E27

012652\*



# Pebetero

## INCANDESCENCIA

 230V

 IP44

**N**/ Para portalámparas estanco.  
**E**/For waterproof lampholder.  
**F**/ Pour la douille imperméable à l'eau. **P**/ Para portalámpada impermeável.

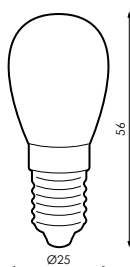

**W** 10W



E14  
Latón

065153



# String Flash

SMART  
LINK 



 230V dc

 CII

 IP44

 -20°C~+60 °C

 NO INC.



146579



146586



3m



3



1,9W



10sets

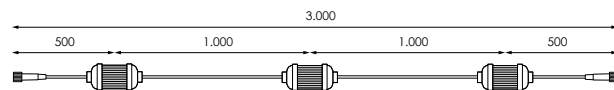

ESQUEMA INSTALACIÓN/  
INSTALLATION SCHEME/  
SCHEMA D'INSTALLATION/  
ESQUEMA DE INSTALAÇÃO



+

Producto/Product  
Produit/Produto

Accesorios/Accessories/Accessoires/Acessórios + INFO PAG. 434



995092

Cable alimentación Negro

977722

Cable alimentación Blanco





# PARTYLIGHT

*En PRILUX damos luz a tus eventos, diseñamos iluminación adecuada para tus celebraciones creando el ambiente idóneo para una fiesta inolvidable.*

*At PRILUX we give light to your events, we design adequate lighting for your celebrations creating the ideal environment for an unforgettable party.*

*Chez PRILUX, nous éclairons vos événements, nous concevons un éclairage adéquat pour vos célébrations, créant l'environnement idéal pour une fête inoubliable.*

*Na PRILUX, damos luz aos seus eventos, nós projetamos iluminação adequada para suas celebrações, criando o ambiente ideal para uma festa inesquecível.*

# GUIRNALDA E14

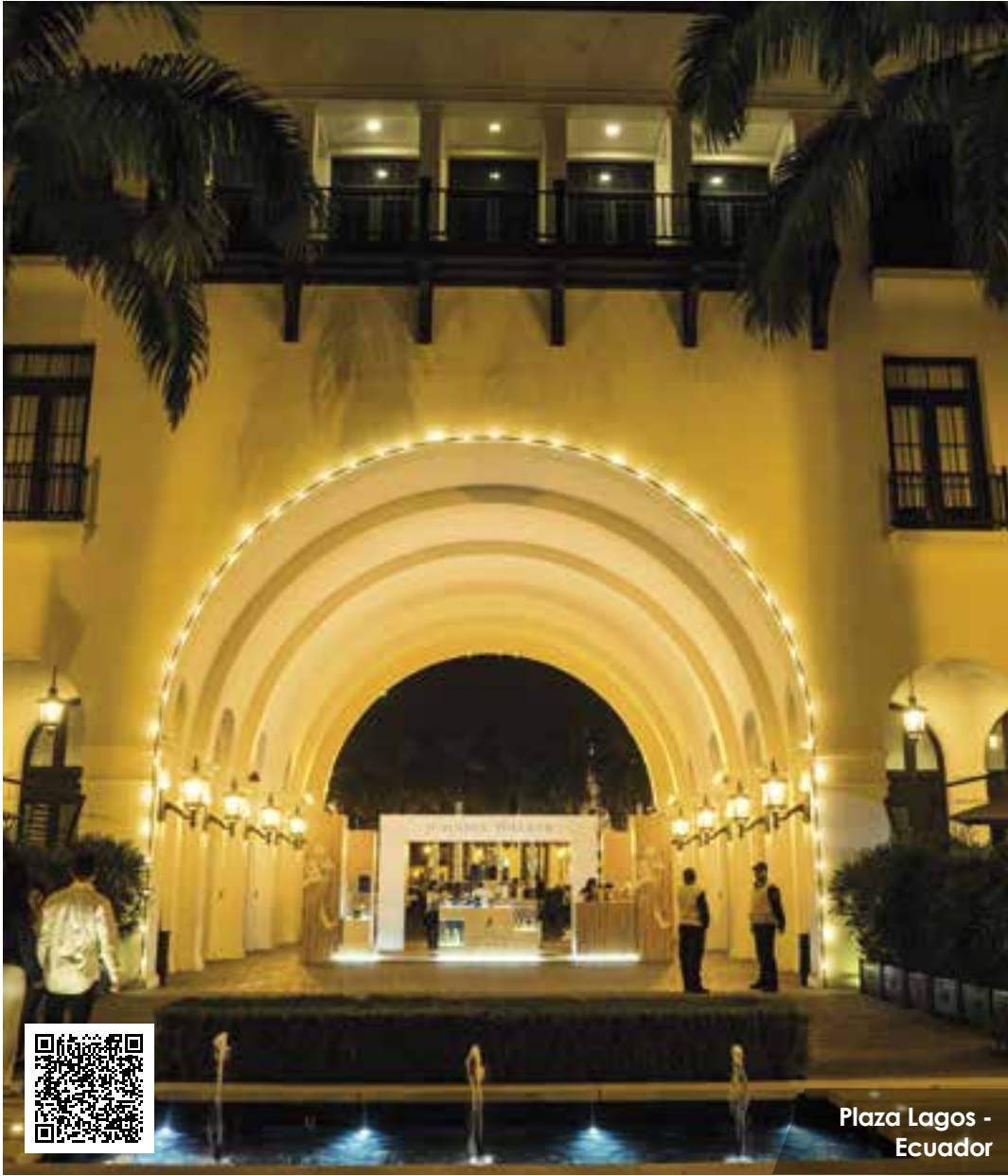

Plaza Lagos - Ecuador

⚡ 230V

☐ CII

⊕ IP44

🔌 INC.



	∞
392105	☑

↔	15m
W/☑	20W
☑	60

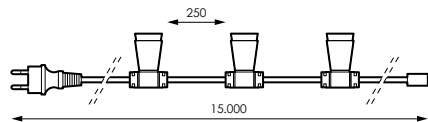

	∞
392112	☑

↔	50m
W/☑	5W
☑	200

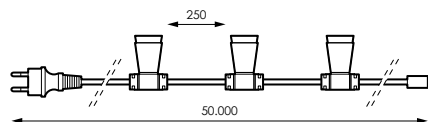

# GUIRNALDA E27

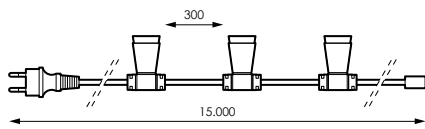

15m



20W



45



392075

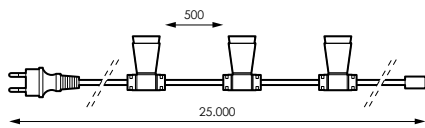

25m



20W



50



446433

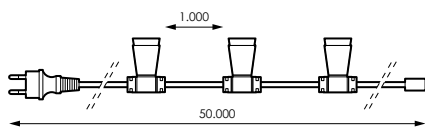

50m



20W



50



446440

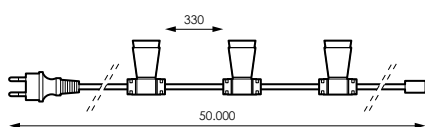

50m



5W



150



392082

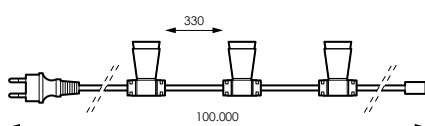

100m



2W



300



392099



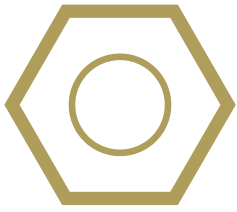

# Accesorios

Accessories  
Accessoires  
Acessórios

		CLUSTER SHOP MICROLED	ICICLE# MICROLED	LED FIREWORKS	WILLOW LIGHT	LED FOUNTAIN	FALL LITE LED SMART	SNOWLITE LED	STRING FLASH	SMART 20 LIGHT	FALL LITE LED	esSENSE LED	PEBETERO LED	FLASH LIGHT LED
	149181			•										
	149198			•										
	149204			•										
	149211			•										
	193061						•			•				
	193078						•	•		•				
	444446	•	•											
	977722						•		•					
	995092						•		•					
		146623											•	
192316												•		•
391511											•		•	•
391528											•		•	•
447720			•										•	•
	401371					•								
	401388				•									

## TRANSFORMADOR MICROLED

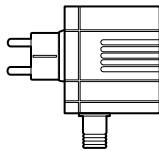

## EXTENSIÓN MICROLED

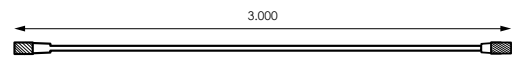

		<b>W</b>	
444446	24V	Máx. 25W	IP20

447720	3m	CII	IP20

## SOPORTE PARED WILLOW LIGHT

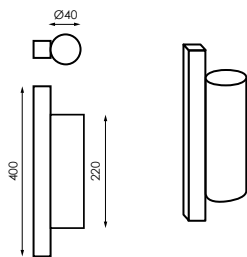

## SOPORTE PARED LED FOUNTAIN

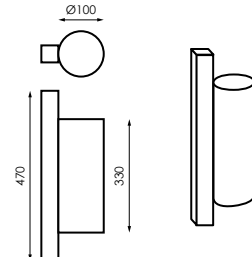

401388		INT.	EXT.

401371		INT.	EXT.

**TRANSFORMADOR 24V**

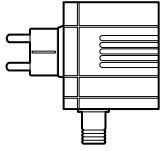

**149181**      **Máx. 10,8W**

Sin rectificador  
Without rectifier  
Sans redresseur  
Sem retificador

**TRANSFORMADOR 24V**

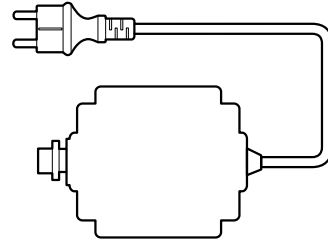

**149198**      **Máx. 28,8W**

Sin rectificador  
Without rectifier  
Sans redresseur  
Sem retificador

**TRANSFORMADOR 24V**

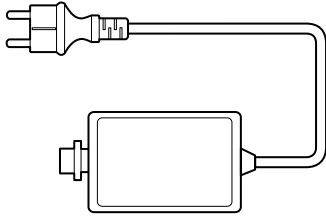

**149204**      **Max. 60W**

Sin rectificador  
Without rectifier  
Sans redresseur  
Sem retificador

**TRANSFORMADOR 24V**

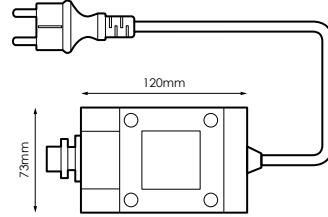

**149211**      **Max. 120W**

Sin rectificador  
Without rectifier  
Sans redresseur  
Sem retificador

**CABLE ALIMENTACIÓN**

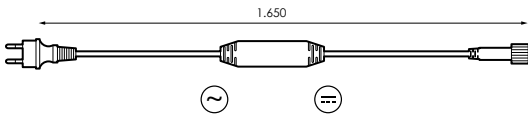

Icon	Code	Voltage	Power	Class	IP
	<b>995092</b>	230Vac	Max. 480W	CII	IP44
	<b>977722</b>	230Vac	Max. 480W	CII	IP44

**CABLE ALIMENTACIÓN**

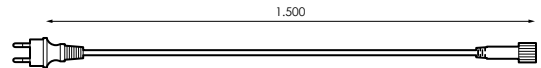

Icon	Code	Voltage	Power	Class	IP
	<b>193061</b>	230Vac	Max. 480W	CII	IP44
	<b>193078</b>	230Vac	Max. 480W	CII	IP44

**SMART E27/E14 SMART LINK**

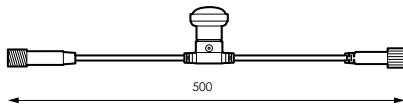

Code	Base Type	Icon
<b>391528</b>	<b>E14</b>	
<b>391511</b>	<b>E14</b>	
<b>192316</b>	<b>E27</b>	
<b>146623</b>	<b>E27</b>	

# Anexos

---

*Annexes*  
*Annexes*  
*Anexos*



# Reparación tramo Flexilight

Repair of the Flexilight segment

Réparation du segment Flexilight

Reparação do segmento Flexilight

1

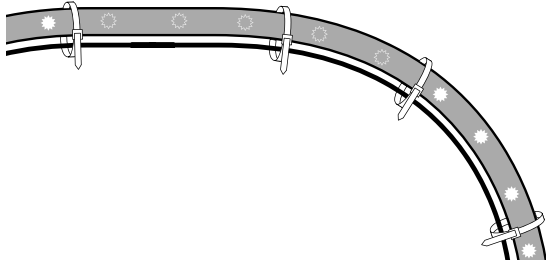

2

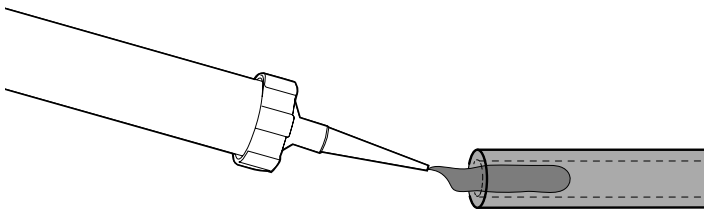

3

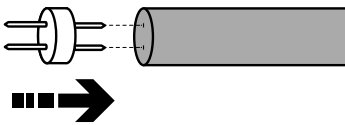

Ñ/ ASEGÚRESE DE QUE LA POLARIDAD Y EL SENTIDO DE LA CORRIENTE SON LOS CORRECTOS.

F/ ASSUREZ-VOUS QUE LA POLARITÉ ET LA DIRECTION DE LA PUISSANCE SONT CORRECT.

E/ MAKE SURE THAT THE POLARITY AND THE POWER DIRECTION ARE CORRECT.

P/ CERTIFIQUE QUE A POLARIDADE E A DIREÇÃO DA CORRENTE SÃO CORRETAS.

4

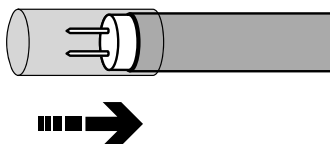

5

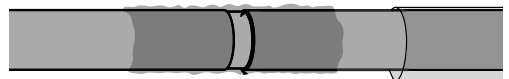
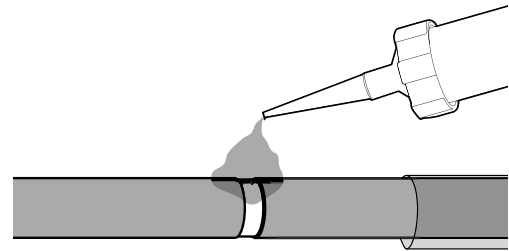
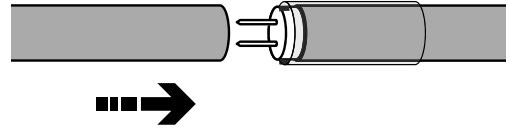

6

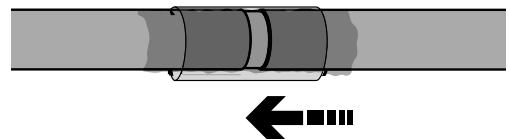

7

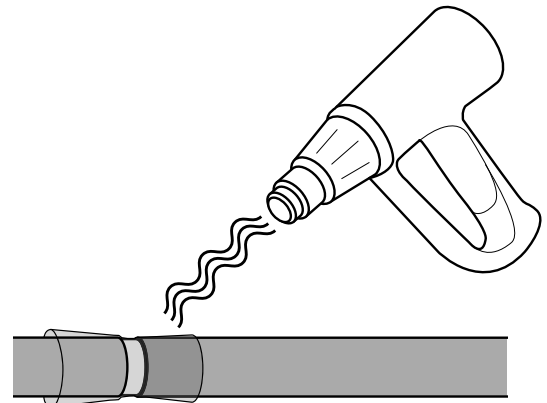

8







9

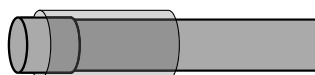
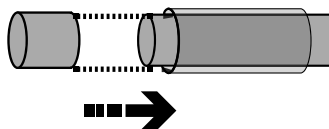

10

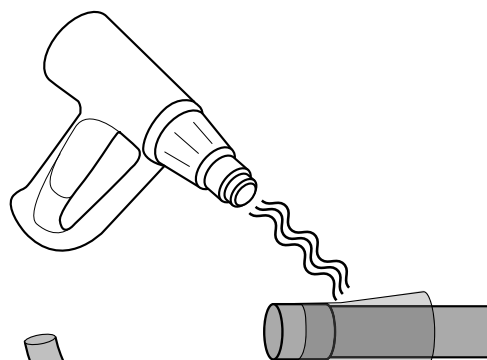

12

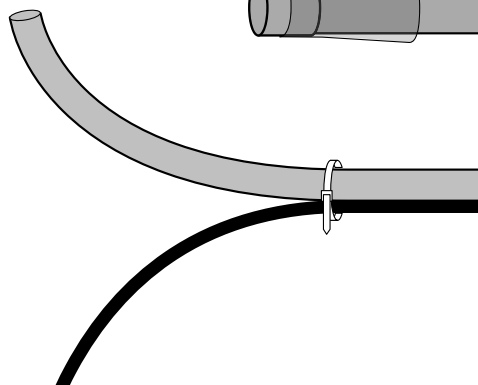

11



**FIG.1** Localice el tramo de hilo a reparar y elimínelo.  
**FIG.2** Corte un tramo de hilo nuevo y selle los orificios internos de ambos extremos con 2 o 3cm de silicona.  
**FIG.3** Inserte un conector introduciendo las patillas metálicas a través de los orificios de los cables metálicos del interior del hilo.  
**FIG.4** Introduzca el termorretráctil por uno de los extremos del hilo para su posterior sellado.  
**FIG.5** Proceda a unir los dos extremos del hilo mediante el conector rellenando el orificio con 2cm de silicona. **Una vez unidos los dos extremos aplique y extienda silicona sobre la unión y parte del hilo.**  
**FIG.6** Coloque el termorretráctil sobre la junta de los dos tramos de hilo.  
**FIG.7/8** Selle la junta calentando el termorretráctil.  
**FIG.9/10/11** Repita este proceso en los extremos de los tramos a sustituir colocando un tapón para rematar los tramos finales del hilo. No olvide rellenar los orificios con silicona.  
**FIG.12** Fije los tramos de hilo a la estructura del motivo.

**FIG.1** Locate the section to repair.  
**FIG.2** Cut a piece of new wire and seal the ends with silicone.  
**FIG.3** Insert a new connector metal entering through wire pin inside the holes of the internal wires.  
**FIG.4** Enter a shrink in the wire's side for its subsequent sealing.  
**FIG.5** Proceed to join the two ends of the wire through the connector. **Then extend and apply silicone on the union and part of the wire.**  
**FIG.6** Introduce the shrink on the joint of the two wire's sections.  
**FIG.7/8** Seal the seam by heating the shrinkable.  
**FIG.9/10/11** Repeat this process at the ends of every sections to be replaced.  
**FIG.12** Set the new sections to the metallic structure.

**FIG.1** Localisez la section de fil de réparation.  
**FIG.2** Coupez un morceau de fil de fer. Sceller les extrémités avec du silicone.  
**FIG.3** Insérer un nouveau connecteur métal entrant dans les trous des fils métalliques dans l'axe du fil.  
**FIG.4** Entrez un psy par une extrémité du fil pour la fermeture ultérieure.  
**FIG.5** Passez à joindre les deux extrémités du fil à travers le connecteur. **Une fois que les deux extrémités ensemble et étendre appliquer silicone sur l'union et une partie du fil.**  
**FIG.6** Introduire le psy sur le plateau des deux sections de fil.  
**FIG.7/8** Sceller le joint en chauffant le psy.  
**FIG.9/10/11** Répétez ce processus sur les extrémités des sections à remplacer.  
**FIG.12** Set mèches la structure du moyen.

**FIG.1** Localize a seção de roscas.  
**FIG.2** Corte um pedaço de arame e selar as extremidades com silicone.  
**FIG.3** Inserir um novo conector de metal que entra através dos orificios dos fios de metal do pino de arame, r uma extremidade do fio para vedação posterior.  
**FIG.5** Unir as duas extremidades do fio através do conector. **Uma vez que as duas pontas e estender aplicar silicone na união e parte da discussão.**  
**FIG.6** Introduzir o termorretráctil no quadro das duas secções de fio.  
**FIG.7/8** Selar a costura por aquecimento do termorretráctil.  
**FIG.9/10/11** Repita este processo as extremidades das secções.  
**FIG.11/12** Set vagueia a estrutura do fundamento.

### Ñ/ Recomendación

Se recomienda la revisión de todas las conexiones y empalmes de los motivos y productos de Navidad antes y después de su puesta en funcionamiento en cada campaña para evitar la dilatación de juntas y condensaciones.

Se recomienda NO dejar expuesto a la intemperie el hilo luminoso más de un año para evitar su degradación por los rayos ultravioletas del sol.

Es recomendable la desinstalación del producto al finalizar cada campaña.

### E/ Recommendation

Reviewing all connections and splices motives and Christmas products is recommended before and after their operation in each campaign to prevent condensation and expansion joints.

It is recommended NOT expose to weather the bright thread over a year to prevent degradation by ultraviolet rays.

We recommend uninstalling the product at the end of each campaign.

### F/ Recommandatio

Revoir toutes les connexions et raccords de motifs et de produits de Noël est recommandé avant et après leur opération dans chaque campagne pour éviter la condensation et les joints de dilatation.

Il est recommandé de ne pas exposer aux intempéries le fil lumineux plus d'un an pour éviter dégradation par les rayons ultravioletes.

Nous recommandons de désinstaller le produit à la fin de chaque campagne.

### P/ Recomendação

Rever todas as conexões e emendas motivos e produtos de Natal é recomendada antes e após a sua operação em cada campanha para evitar a condensação e expansão articulações.

Recomenda-se não expor para enfrentar a linha brilhante ao longo de um ano para evitar degradación pelos raios ultravioleta.

Recomendamos desinstalar o produto, no final de cada campanha.

# Reparación cable alimentación

Repair of the power cable

Réparation du câble d'alimentation

Reparação do cabo de alimentação

1



2

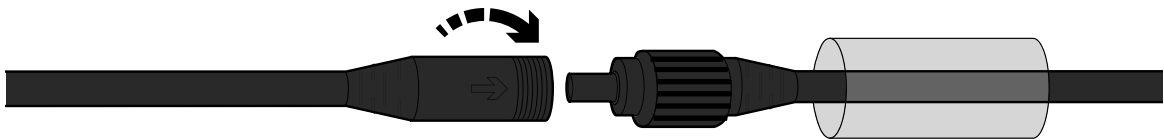

3

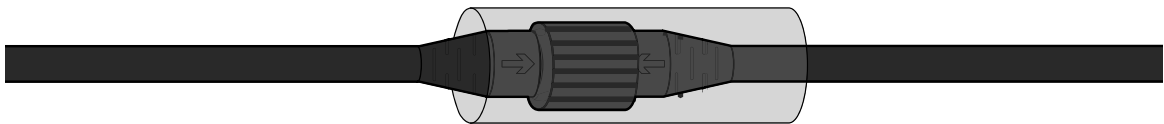

4

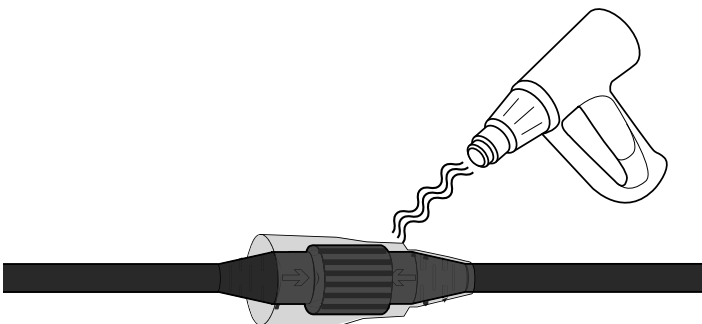

5

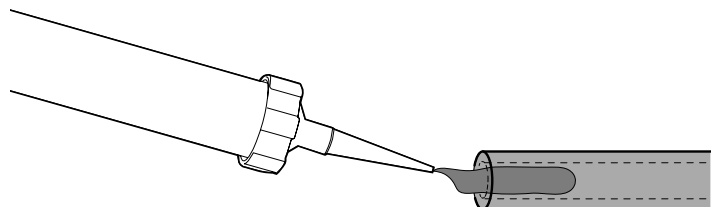



6

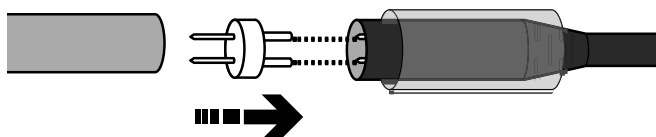

7

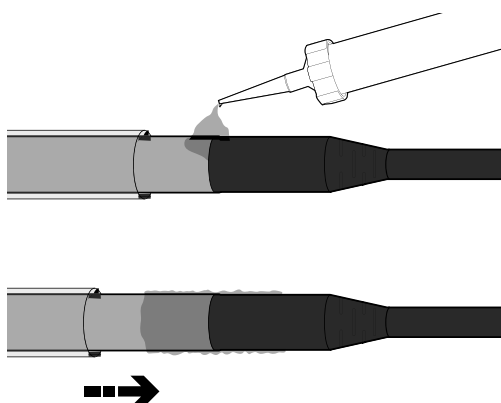

8

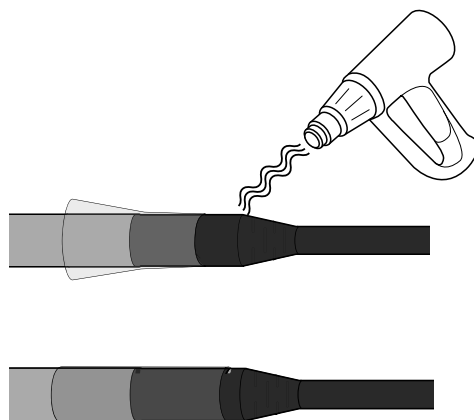

**FIG.1** Proceda a unir el cable de alimentación o en el empalme estanco insertando previamente el termorretráctil en uno de los dos elementos.

**FIG.2** Conecte las clavijas del cable de alimentación y el empalme estanco, roscando la tapa posteriormente.

**FIG.3** Coloque el termorretráctil sobre la unión de los dos elementos.

**FIG.4** Caliente el termorretráctil para sellar la junta.

**FIG.5** Rellene los orificios internos del extremo del hilo con 2 o 3cm de silicona.

**FIG.6** Proceda realizar la union entre cable de alimentación e hilo insertando el conector adecuado entre ambos elementos. Previamente debe introducirse un termorretráctil para su posterior sellado.

**FIG.7** Una vez unidos los dos extremos aplique y extienda silicona sobre la unión y parte del hilo.

**FIG.8** Coloque el termorretráctil sobre la unión de los elementos y aplique calor para su correcto sellado.

**FIG.1** Proceed to attach the power cable or by inserting the previously sealed shrink splice in one of the two elements.

**FIG.2** Connect the power cord plugs and tight fitting, screwing the lid later.

**FIG.3** Place the heat shrink over the joint of the two elements.

**FIG.4** Heat shrink to seal the joint.

**FIG.5** Seal the ends with silicone.

**FIG.6** Proceed to perform the union between power cord and thread inserting the appropriate connector between the two. Formerly must enter a shrink for sealing later.

**FIG.7** Then extend and apply silicone on the union and part of the wire.

**FIG.8** Place the shrink over the joint elements and apply heat for proper sealing.

**FIG.1** Procéder à brancher le câble d'alimentation ou par l'insertion, jonction rétractable déjà scellé dans l'un des deux éléments.

**FIG.2** Branchez les fiches du cordon d'alimentation et bien ajusté, de visser le couvercle plus tard.

**FIG.3** Placez le rétrécissement de la chaleur sur le joint des deux éléments.

**FIG.4** Thermorétractables l'étanchéité du joint.

**FIG.5** Sceller le extrémité avec du silicone.

**FIG.6** Passez à effectuer l'union entre le cordon d'alimentation et du fil de brancher le connecteur approprié entre les deux. ( Anciennement doit entrer un psy pour fermer ultérieurement.

**FIG.7** Une fois que les deux extrémités ensemble et étendre appliquer silicone sur l'union et une partie du fil.

**FIG.8** Placez le rétrécissement de la chaleur sur les éléments communs et appliquer de la chaleur pour une bonne étanchéité.

**E/ MAKE SURE THAT THE POLARITY AND THE POWER DIRECTION ARE CORRECT.**

**P/ CERTIFIQUE QUE A POLARIDADE E A DIREÇÃO DA CORRENTE SÃO CORRETAS.**

### Ñ/ Recomendación

Se recomienda la revisión de todas las conexiones y empalmes de los motivos y productos de Navidad antes y después de su puesta en funcionamiento en cada campaña para evitar la dilatación de juntas y condensaciones.

Se recomienda NO dejar expuesto a la intemperie el hilo luminoso más de un año para evitar su degradación por los rayos ultravioletas del sol.

Es recomendable la desinstalación del producto al finalizar cada campaña.

### E/ Recommendation

Reviewing all connections and splices motives and Christmas products is recommended before and after their operation in each campaign to prevent condensation and expansion joints.

It is recommended NOT expose to weather the bright thread over a year to prevent degradation by ultraviolet rays.

We recommend uninstalling the product at the end of each campaign.

### F/ Recommandatio

Revoir toutes les connexions et raccords de motifs et de produits de Noël est recommandé avant et après leur opération dans chaque campagne pour éviter la condensation et les joints de dilatation.

Il est recommandé de ne pas exposer aux intempéries le fil lumineux plus d'un an pour éviter dégradation par les rayons ultraviolets.

Nous recommandons de désinstaller le produit à la fin de chaque campagne.

### P/ Recomendação

Rever todas as conexões e emendas motivos e produtos de Natal é recomendada antes e após a sua operação em cada campanha para evitar a condensação e expansão articulações.

Recomenda-se não expor para enfrentar a linha brilhante ao longo de um ano para evitar degradação pelos raios ultravioleta.

Recomendamos desinstalar o produto, no final de cada campanha.

## Ñ/ Condiciones generales

La aceptación por nuestra parte de un pedido supone, en cualquier caso, que el comprador acepta las siguientes condiciones generales de venta y suministro:

### 1. Precios.

Los precios indicados son precios recomendados y se entienden sin I.V.A. ni Ecoraee y son válidos desde el 1 de Julio de 2021 hasta nuevo aviso. Una vez realizada la factura se aplicarán ambos. Los precios de la Tarifa Vigente, son para aquellos materiales que se hallen en nuestros almacenes.

Nos reservamos el derecho de modificaciones de precios y características de los productos comunicándolo lo antes posible.

### 2. Plazos de entrega.

Nuestro plazo de entrega será inmediato y en su defecto, a corto plazo. Los plazos de entrega se respetarán según nuestras posibilidades, pero son sin compromiso. Dichos plazos son meramente informativos. Los retrasos en la entrega no autorizan al comprador a la anulación del pedido ni a la aplicación de penalizaciones ni indemnizaciones, salvo que se haya convenido expresamente lo contrario. Aun en este caso, habiendo causas de fuerza mayor de por medio, propia o ajena, deja de cumplirse alguno de los compromisos acordados, no será aplicable sanción alguna.

### 3. Ofertas.

Las ofertas escritas u orales, no nos comprometen a aceptarlas. Dichas ofertas tendrán validez una vez hayan sido ratificadas por escrito por GRUPO PRILUX ILUMINACION, S.L.U.

### 4. Transporte.

Una vez la mercancía haya sido entregada a la agencia de transportes, se considerará la entrega como correcta. Los riesgos de transporte en el envío de nuestros productos son por cuenta del comprador, que únicamente podrá reclamar a la agencia encargada del transporte los daños ocasionados en el mismo, en un plazo inferior a 7 días y por escrito con copia a Grupo Prilux Iluminación, S.L.U.

### 5. Reclamaciones.

Reclamaciones relativas a fallos numéricos y defectos, serán solo válidas si se ha enviado la oportuna reclamación dentro de los cinco primeros días a partir de la recepción de la mercancía.

### 6. Devoluciones de material.

No se aceptarán devoluciones de material si previamente GRUPO PRILUX ILUMINACION S.L.U. no lo ha autorizado. Estas devoluciones tendrán que remitirse a portes pagados con un demérito mínimo del 20%. No se acepta la devolución de productos de fabricación especial o de campañas (como la de navidad) y de productos que no vengan en sus embalajes originales y en buen estado. En cualquier caso no se aceptarán devoluciones de productos con antigüedad superior a 12 meses y será imprescindible facilitar el número de factura correspondiente.

### 7. Derechos de propiedad.

GRUPO PRILUX ILUMINACION, S.L.U. conserva, en todo caso, la plena propiedad de todos los materiales suministrados, en tanto no quede cumplida por entero la recíproca condición de pago del importe.

### 8. Pedidos.

Los pedidos en curso podrán ser anulados por Grupo Prilux Iluminación, S.L.U. si surgieran circunstancias de fuerza mayor que impidan que puedan suministrarse dichos pedidos. Los pedidos de materiales de fabricación especial no podrán anularse por el comprador sin nuestra aprobación por escrito. En caso de aceptación por nuestra parte, serán a cargo del comprador los gastos originados hasta el momento de su anulación.

### 9. Reproducción.

Queda prohibida la reproducción total o parcial de este catálogo sin la correspondiente autorización de GRUPO PRILUX ILUMINACION, S.L.U.

### 10. Forma de pago.

La forma de pago será la establecida en el momento de efectuar el pedido en firme de la mercancía, de acuerdo con las normas usuales de GRUPO PRILUX ILUMINACION, S.L.U.

### 11. Lugar de cumplimiento y jurisdicción.

Para cuantas cuestiones puedan surgir en el cumplimiento o interpretación de estas normas generales, los contratantes, con renuncia expresa de cualquier jurisdicción pudieran corresponderles, se someten expresamente a los Juzgados y Tribunales de Toledo.

### 12. Elementos defectuosos y garantía.

El período de garantía comienza en la fecha de factura de GRUPO PRILUX ILUMINACION, S.L.U. La responsabilidad se aplica a los materiales y defectos de fabricación según los estándares técnicos de cada producto. El producto debe instalarse de acuerdo a la normativa vigente y especificaciones de GRUPO PRILUX ILUMINACION, S.L.U. El período de garantía general es de 1 año a partir de la fecha de factura de la mercancía, a excepción de los productos que por sus características técnicas tienen una duración inferior a este período. El período de garantía tiene en cuenta los ciclos de encendidos y apagados marcados en la norma IEC. Finalizado este período, cualquier reclamación, incluso por daños, será rechazada/excluida.

Los productos de navidad, al ser de temporada, tienen montaje y desmontaje normalmente. Esta manipulación y su posterior mantenimiento, es responsabilidad del instalador. GRUPO PRILUX ILUMINACION, S.L.U. no se hace responsable del producto sino se ha producido el mismo.

En caso de defectos la responsabilidad del vendedor estará limitada al precio de venta de la parte defectuosa del producto. Especialmente no habrá responsabilidad de reembolso de los gastos incurridos por el comprador o cambio de productos. Se aplicará especialmente en algún desembalaje y reinstalación de los productos.

GRUPO PRILUX ILUMINACION, S.L.U. no se responsabiliza de los daños causados por el cliente o por una tercera persona externa al producto. GRUPO PRILUX ILUMINACION, S.L.U. no se responsabiliza de las alteraciones o cambios realizados en cualquiera de los productos por terceras personas.

Se limita la responsabilidad del vendedor en aquellos casos de negligencia grave o daños ocasionados intencionadamente.

La compañía no se responsabiliza de los productos usados.

### Directiva ROHS

La Directiva sobre Restricciones a la utilización de determinadas Sustancias Peligrosas en Aparatos Eléctricos y Electrónicos (RoHS) entra en vigor el 1 de julio de 2006. A partir de esta fecha, los productores de ciertas categorías de aparatos eléctricos y electrónicos no podrán comercializar productos que contengan seis sustancias prohibidas, a menos que se les apliquen exenciones específicas. Estas sustancias son:

Plomo (Pb), Mercurio(Hg), Cromo hexavalente(Cr(VI)), Cadmio(Cd), pirorretardantes como Polibromobifenilos(PBB) o Polibromodifeniléteres(PBDE) .

## E/ General conditions

The acceptance of an order by us means, in any case, that the buyer agrees with the following general conditions of Sales and Delivery:

### 1. Price.

All the prices indicated are recommended and there come without VAT and without ECO-RAEE and there are valid from July 1, 2021 until further notice. Once the commercial invoice is issued, both terms will be applied on it. The prices from the "Tarifa Vigente" make reference to all the products which are located in our warehouses.

We reserve the right to modify the pricing and characteristics of our products, notifying them as soon as possible.

### 2. Delivery time.

Our delivery time will be immediate, otherwise, in short-term. The delivery time will be met according to our means, but not binding. Those terms are merely informative. The delay in the delivery does not entitle the buyer to cancel the order or to claim any compensation or penalties, unless otherwise agreed by the parties. Even if it was the case, for causes of force majeure, either personally or behalf of third parties, which would lead to a breach in some of the terms agreed, no penalty could be applied.

### 3. Offers.

The written and oral proposals do not compromise us to accept them immediately. Those offers will be valid once ratified in writing by GRUPO PRILUX ILUMINACION, S.L.U.

### 4. Transport.

Once the merchandise has been handed to the carrier, the delivery will be considered as proper. The risk of transport is borne by the customer, who only can claim directly to the transport agency, which is in charge of the delivery, for the damage caused during the transport, within less than seven days and in writing and with copy to GRUPO PRILUX ILUMINACION, S.L.U.

### 5. Claims.

All claims relating to numerical errors and defects will be considered valid only if the claim has already been submitted within the five days from the reception of goods.

### 6. Returns.

GRUPO PRILUX ILUMINACION S.L.U. does not accept any material returned without its previous consent. These returns have to be forwarded in carriage prepaid with a minimum demerit of 20%. Returns of custom-made products, from campaigns (like christmas) and those ones which do not come in their original packaging and are not in good condition, may not be accepted. In any case, returns of products that exceed 12 months will not be accepted; it is essential to provide the number of the corresponding invoice.

### 7. Property Rights.

GRUPO PRILUX ILUMINACION S.L.U. keeps, in any case, the full property of all the materials already supplied, until the reciprocal condition of payment is entirely fulfilled.

### 8. Orders.

Ongoing orders can be cancelled by GRUPO PRILUX ILUMINACION S.L.U., when circumstances of force majeure arise, making impossible to be provided. The orders of custom-made products may not be cancelled by the buyer without our written approval. In case of acceptance by us, the buyer has to cover all the costs caused until the cancellation.

### 9. Reproduction.

This publication may not be reproduced in whole or in part without GRUPO PRILUX ILUMINACION S.L.U. express authorization.

### 10. Payment method.

The method of payment will be established when there is a firm order, in accordance with the usual procedure of GRUPO PRILUX ILUMINACION S.L.U.

### 11. Place of fulfillment and jurisdiction.

Any questions arising in relation to the fulfillment and interpretation of the General Conditions, the contracting parties, expressly relinquish to any other jurisdiction that may be applicable, are subject to the jurisdiction of the Courts and Tribunals of Toledo (Spain).

### 12. Defective items and warranty.

The guarantee period begins the date of the commercial invoice is issued by GRUPO PRILUX ILUMINACION S.L.U. The liability applies to the materials and manufacturing defects in accordance with the technical standards of each product. The product must be installed in compliance with the current legislation and with the specifications from GRUPO PRILUX ILUMINACION S.L.U. The general guarantee period is one year starting from the date of the commercial invoice, with the exception of the products which, due to its technical characteristics, have a shorter period. The guarantee period includes the number of on/off cycles defined by the IEC standard. After the deadlines above mentioned, any claim, including for damages, will be fully rejected/ excluded.

Christmas products, due to its seasonal character, require usually assembly and dismantling. The handling and its subsequent maintenance are installer's responsibility. GRUPO PRILUX ILUMINACION S.L. does not take any responsibility in case it has not been done properly.

In case of defects, the seller responsibility is limited to the sale price of the defective part of the product. Especially, there is no liability for the repayment in the costs incurred by the buyer or in the product replacement. This applies particularly in the unpacking and in the reinstallation of equipment.

GRUPO PRILUX ILUMINACION, S.L.U. does not assume any responsibility for the damages resulting from the client or third party external to the product. GRUPO PRILUX ILUMINACION, S.L.U. does not take any liability for the alteration and manipulation in any of our products by third parties.

The seller liability is limited in those cases where gross negligence or intention is involved.

The company accepts no responsibility for used products.

### RoHS Directive

EU legislation, which restricting the use of hazardous substances in electrical and electronic equipment (RoHS) has been in forced since 1st July 2006. From this date, the producers of certain categories of electrical and electronic devices, may not market those products that contain some forbidden substances, unless some specific exemptions are implemented. Those substances are the following: Lead (Pb), Mercury (Hg), Hexavalent Chromium (Cr(VI)), Cadmium (Cd), Polybrominated biphenyls (PBB), and flame retardants such as Polibromodifeniléteres (PBDE).

## F/ Condições gerais

L'acceptation d'une commande par nous signifie, dans tout les cas, que l'acheteur est d'accord avec les suivantes conditions générales de Vente et de Livraison:

- 1. Prix.**  
Tous les prix indiqués sont recommandés et ils sont sans TVA et sans ECORAE. Ils sont valables du 1er Juillet 2021 jusqu'à nouvel ordre. Une fois la facture commerciale est délivrée, les deux termes seront appliqués sur la même. Les prix du "Tarifa Vigente" font référence à tous les produits qui se trouvent dans nos entrepôts.  
Nous nous réservons le droit de modifier les prix et les caractéristiques de nos produits, nous vous les notifier le plus tôt possible.
- 2. Délai de livraison.**  
Notre délai de livraison sera immédiate, sinon, dans à court-terme. Il sera atteint en fonction de nos moyens, mais non contraignant. Ces délais ont un caractère purement informatif. Des retards dans la livraison ne donnent pas le droit à l'acheteur d'annuler la commande ou de réclamer des indemnités ou des pénalités, sauf d'accord contraire entre les parties. Même si ce fut le cas, les retours de produits qui ont plus de 12 mois, ne seront pas acceptés, soit pour compte de tiers, ces qui conduiraient à une rupture de termes convenus, pas de pénalité pouvait être appliqué.
- 3. Offres.**  
Les propositions écrites et orales ne nous compromettent pas les accepter immédiatement. Ces offres seront totalement valables une fois qu'ils auront été ratifiés par écrit par GRUPO PRILUX ILUMINACIÓN S.L.U.
- 4. Transport.**  
Une fois la marchandise a été remise au transporteur, la livraison sera considérée comme correcte. Le risque du transport est supporté par le client, qui seulement peut réclamer directement à l'agence de transports qui a fait le service, par rapport aux dommages causés lors du transport, dans le période de sept jours et sous écrit et copie à GRUPO PRILUX ILUMINACIÓN S.L.U.
- 5. Réclamations.**  
Toutes les réclamations relatives à des erreurs numériques et des défauts, ils seront seulement considérés comme valables, à condition de que la demande a déjà été placée dans les suivants cinq jours après la réception des marchandises.
- 6. Retours.**  
GRUPO PRILUX ILUMINACIÓN S.L.U. décline tout matériel retourné sans autorisation précédente. Ces retours doivent être envoyés en port payé avec une pénalité minimum égale à 20%. Les retours de produits sur mesure, des campagnes (comme Noël) et ceux qui ne viennent pas dans leur emballage d'origine et ne sont pas en bon état, ne seront pas acceptés. Dans tous les cas, les retours de produits qui ont plus de 12 mois, ne seront pas acceptés ; c'est essentiel de présenter le numéro de la facture correspondante.
- 7. Droits patrimoniaux.**  
GRUPO PRILUX ILUMINACIÓN S.L.U. maintient, en tout cas, la pleine propriété de tous les matériels déjà fournis, jusqu'au moment où la condition de réciprocité de paiement a été complètement rempli.
- 8. Commandes.**  
Les commandes en cours peuvent être annulées par GRUPO PRILUX ILUMINACIÓN S.L.U., lors que les circonstances de force majeure font suite et empêchent les mêmes d'être fournies. Les commandes de produits sur mesure ne peuvent pas être annulées par l'acheteur sans notre autorisation écrite. En cas d'acceptation, l'acheteur doit convenir tous les dépenses occasionnées jusqu'à l'annulation.
- 9. Reproduction.**  
Il est strictement interdit de reproduire tout ou partie du présent document sans l'autorisation expresse de GRUPO PRILUX ILUMINACIÓN S.L.U.
- 10. Méthode de paiement.**  
Le mode de paiement sera établi lors d'une commande ferme, d'accord avec aux règles habituelles de GRUPO PRILUX ILUMINACIÓN S.L.U.
- 11. Le lieu d'exécution et la juridiction.**  
Toutes les questions qui concernent l'exécution et l'interprétation des Conditions Générales, les parties contractantes renoncent expressément à la juridiction que pourrait leur correspondre et se soumettent aux tribunaux de Tolède (Espagne).
- 12. Des articles défectueux et Garantie.**  
La période de garantie commence à courir à compter de la date d'émission de la facture commerciale par GRUPO PRILUX ILUMINACIÓN S.L.U. La responsabilité concernant aux matériels et aux défauts de fabrication, elle est en conformité avec les normes techniques de chaque produit. Le produit doit être installé en conformité avec la législation en vigueur et des autres spécifications de GRUPO PRILUX ILUMINACIÓN S.L.U. La période de garanti générale est d'un an à compter de la date d'émission de la facture commerciale, à l'exception des produits qui, en raison de ses caractéristiques techniques, ont une période plus courte. La période de garantie comprend le nombre de cycles d'allumé/éteint définis par la norme CEI. Après les délais mentionnés ci-dessus, toute réclamation, même pour dommages, sera entièrement rejetée/exclue.  
Produits de Noël, en raison de son caractère saisonnier, exigent habituellement montage et de démontage. La manipulation et sa maintenance subsequent sont responsabilité de l'installateur. GRUPO PRILUX ILUMINACIÓN S.L.U. ne prend aucune responsabilité au cas où il n'a pas été fait correctement.  
En cas de dommages, la responsabilité du vendeur est limitée au prix de vente de la partie défectueuse du produit. Surtout, il n'aura pas de responsabilité pour le remboursement des coûts encourus par l'acheteur ou durant le remplacement du produit. Il s'applique particulièrement dans les cas de réinstallation d'équipement et du déballage.  
GRUPO PRILUX ILUMINACIÓN S.L.U. ne prend pas la responsabilité pour les dommages qui viennent du client ou de tiers externes au produit. GRUPO PRILUX ILUMINACIÓN S.L.U. ne prend aucune responsabilité pour la modification et la manipulation de nos produits par des tiers.  
La responsabilité du vendeur est limitée dans ces cas où de la négligence grave ou d'intention sont impliqués.  
La société décline toute responsabilité pour des produits usés.

### Directive RoHS

D'accord avec la législation de l'UE, qui limite l'utilisation de substances dangereuses dans les équipements électriques et électroniques (RoHS) est en vigueur depuis le 1er Juillet 2006. A partir de cette date, les producteurs de certaines catégories de dispositifs électriques et électroniques, ne peuvent pas commercialiser des produits qui contiennent des substances interdites, sauf des dérogations spécifiques sont mises en place. Ces substances sont les suivantes : Plomb (Pb), Mercure (Hg), Chrome Hexavalent (Cr(VI)), Cadmium (Cd), Biphényles Polybromés (PBB) et des retardateurs de flamme comme les Polibromodiphényléthers (PBDE).

## P/ Condições gerais

A nossa aceitação de uma encomenda significa, em qualquer caso, que o comprador concorda com as seguintes condições gerais de Venda e Entrega:

- 1. Preço.**  
Todos os preços aqui indicados são recomendados e vêm sem IVA e sem ECORAE. Eles são válidos de 1º de Julho de 2021 até novo aviso. Uma vez que a fatura comercial seja emitida, ambos os termos serão acrescentados na mesma. Os preços da "Tarifa Vigente" fazem referência a todos os produtos que estão nos nossos armazéns.  
Nós reservamos o direito de modificar os preços e as características das nossos produtos, notifique-os o mais cedo possível.
- 2. Prazo de entrega.**  
O nosso prazo de entrega será imediato, caso contrário, em curto prazo. O mesmo será respeitado de acordo os nossos meios, mas não é forçoso. Esses termos são meramente informativos. O atraso na entrega não dá direito ao comprador para cancelar o pedido ou para reclamar qualquer compensação ou penalidades, salvo acordo em contrário das partes. Mesmo neste caso, se existem causas de força maior, pessoais ou por conta de terceiros, o que levaria a uma violação de algum dos termos acordados, nenhuma penalidade pode ser aplicada.
- 3. Ofertas.**  
As propostas escritas e orais não nos comprometem a aceitar as mesmas imediatamente. Essas ofertas serão válidas uma vez que tenham sido ratificadas por escrito pelo GRUPO PRILUX ILUMINACIÓN S.L.U.
- 4. Transporte.**  
Uma vez que a mercadoria tenha sido entregue ao transportador, a entrega será considerada como correta. O risco de transporte será responsabilidade do cliente, quem só pode reclamar diretamente à agência de transporte, quem faz a entrega, pelos danos causados durante o transporte, em menos de sete dias e por escrito e com cópia para GRUPO PRILUX ILUMINACIÓN S.L.U.
- 5. Requerimentos.**  
Todas as reclamações relativas aos erros numéricos e defeitos serão consideradas válidas somente se o requerimento já tinha sido feito dentro do período de cinco dias a contar da recepção das mercadorias.
- 6. Devoluções.**  
GRUPO PRILUX ILUMINACIÓN S.L.U. não aceitará qualquer material devolvido sem o seu consentimento prévio. Estas devoluções devem ser feitas em transporte pré-pago e com um demérito mínimo dos 20%. As devoluções de produtos personalizados, das campanhas (como o natal) e aquelas que não venham na sua embalagem original ou venham em mau estado, não serão aceitas. Em qualquer caso, a devolução de produtos que excedam os 12 meses, não pode ser aceite; é essencial proporcionar o número da fatura comercial correspondente.
- 7. Direitos da propriedade.**  
GRUPO PRILUX ILUMINACIÓN S.L.U. mantém, em todo caso, a propriedade completa de todos os produtos já fornecidos, até que a condição recíproca de pagamento tenha sido realizada.
- 8. Encomendas.**  
As encomendas em curso podem ser canceladas por GRUPO PRILUX ILUMINACIÓN S.L.U., caso surgissem circunstâncias de força maior que impedissem a sua entrega. As encomendas de produtos personalizados não poderão ser canceladas pelo comprador sem a nossa autorização por escrito. No caso da nossa aceitação, o comprador tem de assumir os custos ocasionados até o cancelamento.
- 9. Reprodução.**  
Esta publicação não pode ser reproduzida no todo ou em parte, sem a autorização expressa do GRUPO PRILUX ILUMINACIÓN S.L.U.
- 10. Pagamento.**  
A forma de pagamento será estabelecida quando a encomenda seja firme, de acordo com as regras usuais de GRUPO PRILUX ILUMINACIÓN S.L.U.
- 11. Local de cumprimento e jurisdição.**  
Quaisquer questões que surjam em relação ao cumprimento e à interpretação das Condições Gerais, as partes contratantes, com expressa renúncia ao foro que possa corresponder-lhes, submetem-se à jurisdição dos Tribunais de Toledo (Espanha).
- 12. Material avariado e Garantia.**  
O período de garantia terá início na data da emissão da fatura comercial pelo GRUPO PRILUX ILUMINACIÓN S.L.U. A responsabilidade aplica-se aos materiais e defeitos de fabrico em conformidade com as normas técnicas de cada produto. O produto deve ser instalado em conformidade com a legislação vigente e com as especificações do GRUPO PRILUX ILUMINACIÓN S.L.U. O período de garantia geral é de um ano a partir da data da fatura comercial emitida, com exceção dos produtos que, devido a suas características técnicas, têm um período mais curto. O período de garantia inclui o número de ciclos ligado/desligado definidos pela norma IEC. Após os prazos acima referidos, qualquer reclamação, incluindo por danos, será totalmente rejeitada/excluída.  
Produtos de Natal, devido ao seu carácter sazonal, requerem normalmente montagem e desmontagem. A manipulação e a sua posterior manutenção são responsabilidade do instalador. GRUPO PRILUX ILUMINACIÓN S.L.U. não assume qualquer responsabilidade no caso de não ter sido feito corretamente.  
Em caso de defeitos, a responsabilidade do vendedor será limitada ao preço de venda da parte defeituosa do produto. Especialmente, não tem responsabilidade nenhuma para o reembolso dos custos suportados pelo comprador ou por substituição de produto. Aplica-se especialmente no caso de desempacotamento e em instalações do equipamento.  
GRUPO PRILUX ILUMINACIÓN S.L.U. não assume a responsabilidade pelos danos feitos pelo cliente ou um terceiro externo ao produto. GRUPO PRILUX ILUMINACIÓN S.L.U. não assume nenhuma responsabilidade pela alteração ou manipulação feita por terceiros nos nossos produtos.  
A responsabilidade do vendedor é limitada nos casos em que existisse negligência ou dolo. A empresa declina qualquer responsabilidade no caso de produtos já usados.

### Diretiva RoHS

De acordo com a legislação europeia, aquela que restringe o uso de substância perigosas em equipamentos elétricos e eletrônicos (RoHS), em vigor desde 1 Julho de 2006. A partir desta data, os produtores de certas categorias de equipamentos elétricos e eletrônicos, não podem comercializar produtos que contêm substâncias proibidas, a menos que alguma isenções específica sejam implementadas. Essas substâncias são: Chumbo (Pb), Mercúrio (Hg), Cromo Hexavalente (Cr(VI)), Cádmio (Cd), Bifenilos Polibromados (PBB) e outros retardadores de chama como os Polibromodifeniléteres (PBDE).



	ESPAÑOL (Ñ)	ENGLISH (E)	FRANÇAIS (F)	PORTUGUÊS (P)
	Código	Code	Code	Código
<b>W</b>	Consumo total (W)	Consumption (W)	Consommation (W)	Consumo (W)
	Modelo	Model	Modèle	Modelo
	Tensión (V)	Voltage (V)	Tension D'Alimentation (V)	Tensão (V)
	Intensidad (A)	Current (A)	Intensité (A)	Intensidade (A)
	Clase I Aislamiento eléctrico	Class I Electrical isolation	Classe I Isolation électrique	Clase I Isolamento elétrico
	Clase II Aislamiento eléctrico	Class II Electrical isolation	Classe II Isolation électrique	Clase II Isolamento elétrico
	Clase III Aislamiento eléctrico	Class III Electrical isolation	Classe III Isolation électrique	Clase III Isolamento elétrico
	IP Índice de estanqueidad	IP Sealing rating	IP Indice d'étanchéité	IP Índice de selagem
	Temperatura de funcionamiento	Operating temperature	Température de service	Temperatura de trabalho
	Canal/Vías	Canal/Ways	Canal/Voies	Canal/Maneiras
	Ángulo de apertura	Opening angle	Angle d'ouverture	Ângulo de abertura
	Número de led	LED number	Nombre de led	Número de led
	Led/m	Led/m	Led/m	Led/m
	Fuente de luz	Light source	Source de lumière	Fonte de luz
	Horas por carga	Hours per charge	Heures par charge	Horas por carga
	Color cuerpo	Body colour	Couleur du corps	Cor do corpo
	Color led	Led colour	Couleur led	Cor led
	Color contorno (1, 2, 3,...)	Contour colour (1, 2, 3,...)	Couleur de contour (1, 2, 3,...)	Cor de contorno (1, 2, 3,...)
	Color relleno (1, 2, 3,...)	Colour fill (1, 2, 3,...)	Remplissage de couleur (1, 2, 3,...)	Preenchimento de cor (1, 2, 3,...)
	Peso	Weight	Poids	Peso
	Altura	Height	Hauteur	Altura
	Longitud	Length	Longueur	Comprimento
	Dimensiones (alto x ancho)	Measures (height x width)	Dimensions (hauteur x largeur)	Dimensão (altura x largura)
	Dimensiones (alto x ancho x profundidad)	Measures (height x width x depth)	Dimensions (hauteur x largeur x profondeur)	Dimensão (altura x largura x profundidade)

	ESPAÑOL (Ñ)	ENGLISH (E)	FRANÇAIS (F)	PORTUGUÊS (P)
	Cuerpo	Body	Corps	Corpo
	Marco	Frame	Cadre	Quadro
	Consumo/Corte	Consumption/Cut	Consommation/Couper	Consumo/Corte
	Corte tira	Strip cut	Coupe bande	Corte tira
	Consumo/Segmento	Consumption/Segment	Consumption/Segment	Consumo/Segmento
	Segmento	Segment	Segment	Segmento
	Número de segmentos	Number of segments	Nombre de segments	Número de segmentos
	Número de led/Segmento	LED number/Segment	Nombre de led/Segment	Número de led/Segmento
	Consumo/Portalámparas	Consumption/Lamp holder	Consommation/Douille	Consumo/Lâmpada
	Portalámparas	Lamp holder	Douille	Lâmpada
	Número de tiras	Number of strips	Nombre de bandes	Número de tiras
	Led/Tiras	Led/Strips	Led/Bandes	Led/Tiras
	Producto para suspender	Product to suspend	Produit à suspendre	Produto para suspender
	Embalaje	Packaging	Emballage	Embalagem
	Número de partes	Number of parts	Nombre de pièces	Número de peças
	Diámetro	Diameter	Diamètre	Diâmetro
	Datos panel solar	Solar panel data	Données de panneau solaire	Dados do painel solar
	Datos batería	Battery data	Données de la batterie	Dados da bateria
	Número de bolas	Number of balls	Nombre de balles	Número de bolas
	Empalmable	Linkable	Empalmable	Junção
	NO Empalmable	NO Empalmable	NO Empalmable	NO Empalmable
	Cable alimentación NO incluido	Power cable NOT included	Câble d'alimentation NON inclus	Cabo de alimentação NÃO incluso
	Cable alimentación incluido	Power cable included	Câble d'alimentation inclus	Cabo de alimentação incluso
	Controlador NO incluido	Controller NOT included	Contrôleur NON inclus	Controlador NÃO incluso
	Controlador incluido	Controller included	Contrôleur inclus	Controlador incluso



	ESPAÑOL (Ñ)	ENGLISH (E)	FRANÇAIS (F)	PORTUGUÊS (P)
	Transformador NO incluido	Transformer NOT included	Transformateur NON inclus	Transformador NAO incluso
	Transformador incluido	Transformer included	Transformateur inclus	Transformador incluso
	Adaptador NO incluido	Adapter NOT included	Adaptateur NON inclus	Adaptador NAO incluso
	Adaptador incluido	Adapter included	Adaptateur inclus	Adaptador incluso
	Rectificador NO incluido	Rectifier NOT included	Redresseur NON inclus	Retificador NAO incluso
	Rectificador incluido	Rectifier included	Redresseur inclus	Retificador incluso
	Fuente de alimentación NO incluida	Power supply NOT included	Alimentation NON inclus	Fonte de energia NAO incluido
	Extensión NO incluida	Extension NOT included	Extension NON inclus	Extensão NAO incluso
	Extensión incluido	Extension included	Extension inclus	Extensão incluso
	Accesorios	Accessories	Accessoires	Acessórios
	Componentes	Components	Composants	Componentes
	Bajo pedido	On request	Sur commande	A pedido
	Información	Information	Information	Informações
	Aviso	Notice	Avis	Aviso
	Video demostrativo	Demonstration video	Vidéo de démonstration	Vídeo de demonstração
	Ficha Técnica	Data Sheet	Fiche Technique	Ficha Técnica
	Motivo Fachada	Motifs Facade	Motifs Façade	Motivo Fachada
	Motivo Farola	Motifs Streetlight	Motifs Lampadaire	Motivo Poste de luz
	Motivo Calle	Motifs Street	Motifs Rue	Motivo Rua
	Motivo de interior	Motifs inside	Motifs à l'intérieur	Motivo dentro
	Motivo 3D	Motifs 3D	Motifs 3D	Motivo 3D
	Motivo Mini	Motifs Mini	Motifs Mini	Motivo Mini

LED	MICRO	CABLE	PVC	ESPAÑOL (Ñ)	ENGLISH (E)	FRANÇAIS (F)	PORTUGUÊS (P)
-	-			Blanco	White	Blanc	Branco
-	-		-	Negro	Black	Noir	Preto
	-	-	-	Diamond (8.000K)	Diamond (8.000K)	Diamond (8.000K)	Diamond (8.000K)
	-	-	-	Blanco frío (6.500K)	Cool white (6.500K)	Blanc froid (6.500K)	Branco frio (6.500K)
	-	-	-	Blanco cálido (3.000K)	Warm white (3.000K)	Blanc chaud (3.000K)	Branco quente (3.000K)
	-	-	-	Blanco neutro (4.000K)	Neutral White (4.000K)	Blanc neutre (4.000K)	Branco neutro (4.000K)
-				Transparente	Transparent	Transparent	Transparente
				Azul	Blue	Bleu	Azul
	-	-	-	Verde manzana	Apple green	Vert pomme	Maçã verde
				Verde claro	Light green	Vert clair	Luz verde
-	-		-	Verde oscuro	Dark green	Vert foncé	Verde escuro
				Amarillo	Yellow	Jaune	Amarelo
	-	-	-	Amarillo intenso	Deep yellow	Jaune profond	Amarelo escuro
				Rojo	Red	Rouge	Vermelho
	-			Rosa	Pink	Rose	Rosa
-		-		Fucsia	Fuchsia	Fuchsia	Fúcsia
	-			Púrpura	Purple	Pourpre	Roxo
	-			Naranja	Orange	Orange	Laranja
	-		-	Dorado	Golden	D'or	Dourado
	-	-	-	Dual	Dual	Double	Duplo
	-	-	-	RGB	RGB	RVB	RGB
	-	-	-	RGBW	RGBW	RVBW	RGBW
	-	-	-	RGBWW	RGBWW	RVBWW	RGBWW
	-	-	-	CW-WW	CW-WW	CW-WW	CW-WW
	-	-	-	Multicolor	Multicolored	Multicolore	Multicolorido
	-	-	-	Flashing	Flashing	Clignotant	Piscando
	-	-	-	ALL Flashing	ALL Flashing	Tous Clignotant	Todos Piscando
	-	-	-	Sparkles	Sparkles	Sparkles	Sparkles

# GRUPO PRILUX ILUMINACIÓN S.L.U.

## SEDE CENTRAL

C/ Río Jarama nº 149.45007, Toledo (Spain).  
Tel.: (+34) 925 23 38 12 / Fax: (+34) 925 23 38 80

## DELEGACIÓN NORESTE

Carretera BV - 2249 Km 8  
08791, Sant Llorenç d'Hortons, Barcelona (Spain).  
**Prilux eConcept** Tel.: (+34) 93 891 37 24  
**Grupo Prilux Iluminación S.L.U** Tel: (+34) 93 719 23 29

[www.grupoprilux.com](http://www.grupoprilux.com)

## IMPRESIÓN

Julio 2021

## DISEÑO GRÁFICO

Departamento de Marketing

Pueden aparecer variaciones con respecto al color original debido a causas técnicas de la impresión.

Este catálogo actualiza los valores y características de las mismas luminarias que aparezcan en anteriores catálogos.

Los datos incluidos en este catálogo son correctos salvo error tipográfico.

Grupo Prilux Iluminación S.L.U. se reserva el derecho a cualquier modificación del producto sin previo aviso.

Web



**Tarifa**  
Price list  
Liste de prix  
Lista de preços



#led's **PLAY!**

[www.priluxconcept.com](http://www.priluxconcept.com)

